

CMT ORANGE TOOLS®

CATALOGUE 2024 ENGLISH EDITION

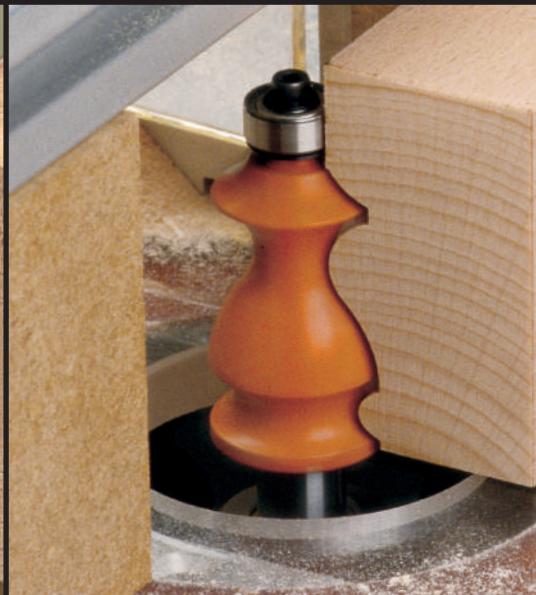
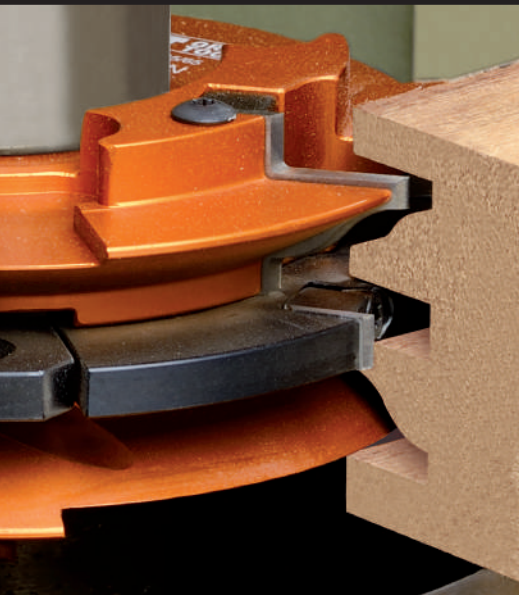

Welcome to the 2024 catalogue

Dear Customer,

Thank you for your interest in CMT products.

Take a moment to browse our new catalogue and choose from an even wider range of innovative and state-of-the-art woodworking tools, from router bits, saw blades, jig and sabre saw blades, hole saws, and boring bits to oscillating tools, CNC cutters, cutter heads, chucks, power tools, and so much more!

A detailed list of spare parts on each product category is also provided to guide you through your purchase.

We continually strive to develop our technical know-how and make significant investments in research and development, but our greatest priority is customer care. A satisfied customer is worth more than any other achievement; therefore, each page of this catalogue contains CMT's highest commitment to the professional woodworker.

Should you not find a product that suits your needs, please let us know. Our highly skilled engineers and design technicians are always keen to assist you with your woodworking operations.

Thank you for your interest in CMT Orange Tools.

Your CMT Team



OUR CHANNELS



www.cmtorangetools.com

YouTube



www.youtube.com/user/cmtorangetools



www.facebook.com/cmt.italy



www.instagram.com/cmt_orangetools

Blade Chart Abbreviations

- B** = Bore Diameter
- D** = Diameter
- K** = Kerf Thickness
- P** = Plate Thickness
- PH** = Pin Hole
- PITCH T** = $(D * 3.14) / Z$
- RPM** = Round per Minute
- T₁** = Workable Thickness
- V** = N° of Rakers
- Z** = N° of Teeth

- α = Hook Angle
- β = Type of Grind:
 - ATB** = Alternate Top Bevel Grind
 - CO / CONICAL** = Conical Teeth
 - FFT** = Flat Flat Trapezoidal
 - FLAT / FTG** = Flat Top Grind
 - FWF** = Flat with Alternate Chamfer
 - HDF** = Hollow Ground Teeth
 - Hi-ATB** = High Alternate Top Bevel Grind
 - HR** = Hollow Back Tooth Configuration
 - MATB** = Alternate Top Bevel with Chamfer Grind
 - MTCG** = Triple Chip Grind (Trapezoidal) with Chamfer
 - TCG** = Triple Chip Grind (Trapezoidal)

- BW** = Bevel Alternate (Metal Cutting)
- C/HZ** = Double Bevel and Flat (Metal Cutting)

Chart Abbreviations

- α = Axial Angle
- A** = Angle
- B** = Bore Diameter
- D / D₂ / d** = Diameter
- H** = Cutting Depth
- l / l₁** = Cutting Length
- K** = Thickness
- L / L₁** = Overall Length
- LB** = Relative Length
- R / R₁** = Radius
- RPM** = Round per Minute
- S / S₁** = Shank Diameter
- T₁** = Workable Thickness
- TPI** = Teeth per Inch
- TS** = Tooth Spacing
- V** = N° of Spurs
- W** = Width
- Z** = N° of Teeth

-  = Dispatch Package Q.ty (Inner Pack)

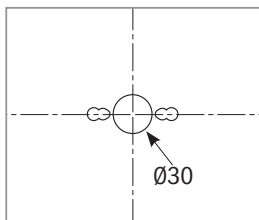

COMBI3
 2/7/42mm
 2/9/46,4mm
 2/10/60mm

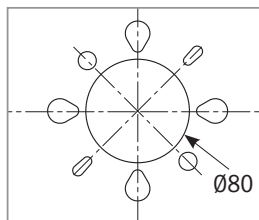

COMBI5
 2/7/110mm
 2/8,4/130mm
 2/14/110mm
 4/9/100mm
 4/19/120mm

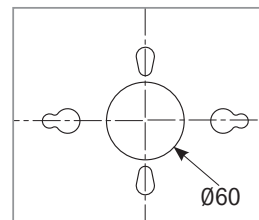

COMBI7
 2/10/80mm
 1/11/85mm
 2/11/115mm
 2/11/148mm
 2/14/100mm
 2/14/125mm
 2/19/120mm

THE RIGHT TOOLS FOR THE BEST RESULTS!

Quick reference charts and pictograms help you choose the right tools for your application.



	SAW BLADES	JIG SAW BLADES	SABRE SAW BLADES	MULTI-CUTTERS	HOLE SAWS
WOOD					CARBIDE
WOOD & METAL	✓	✓	✓	✓	
METAL					BI-METAL
NON-FERROUS					
MULTI-MATERIALS					
SPECIAL / MASONRY					DIAMOND GRIT

CMT HISTORY

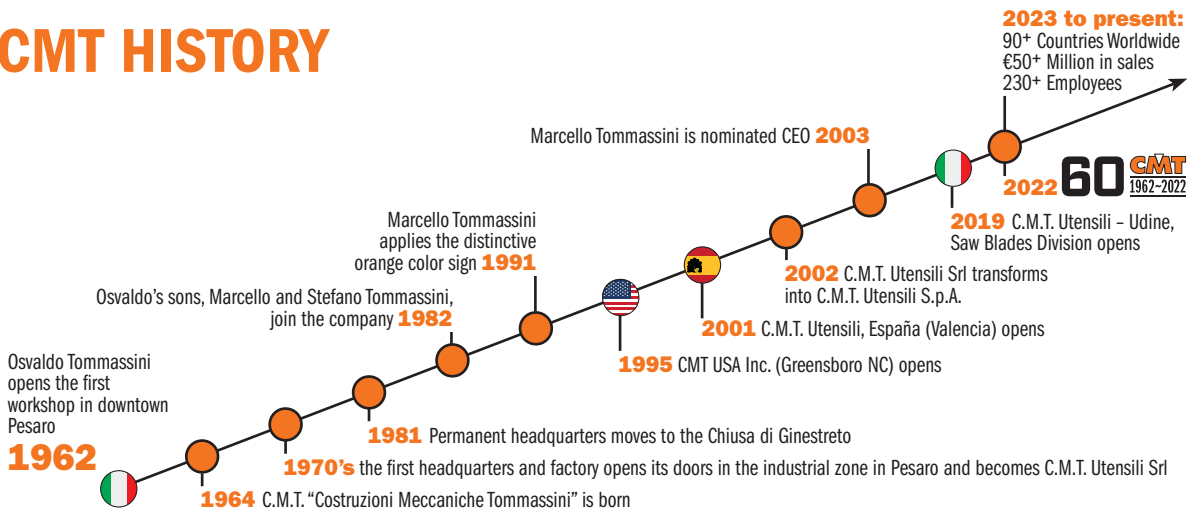

CMT headquarters in the 1970's

CMT LOGO EVOLUTION



Hello there!

My name is **CMT ORANGE TOOLS**, I am the brand name of a dynamic Italian company which I am proud to tell you about. I was born in **1962** thanks to the initiative of my creator and company founder, Osvaldo Tommassini.

By the way, **CMT** stands for Costruzioni Meccaniche Tommassini. Over the years, my appearance has changed significantly.

In **1991** and **1997**, my two brothers (Bit and Blade) were born and following them, many others.

Orange by birth, together we make a great team and are synonymous with quality!

Today, after much hard work, our name has gone global so much so that our photo is registered in Trademark offices around the world.

Present in 90 countries around the world, our family has grown, the result of undying enthusiasm and above all,

the color **ORANGE!**

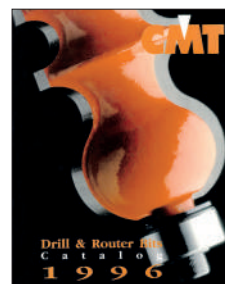

Our first catalogs

CMT HISTORY & LOGO EVOLUTION



SAW BLADES

4~82



JIG SAW BLADES

83~89



SABRE SAW BLADES

90~103



TOOLS FOR MULTI-CUTTERS

105~130



TOOLS WITH BORE & KNIVES

131~173

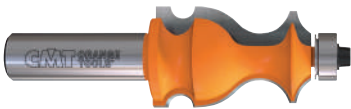

ROUTER BITS & SET

174~279



CNC ROUTER CUTTERS & CHUCKS

280~326



INDUSTRIAL DOWEL DRILLS

327~354



BITS FOR HAND POWER TOOLS

355~373



HOLE SAWS & MULTI-MATERIAL WHEELS

374~390



POWER TOOLS, JIGS & ACCESSORIES

391~425



DISPLAY CABINETS

426~435



SPARE PARTS

436~441



**MADE IN ITALY
SINCE 1962
60 YEARS
AND STILL
GOING STRONG!**

By now, the story has been told. After over 60 years of success and quality in manufacturing woodworking tools - orange woodworking tools, to be precise - word just sort of gets around. We have grown and we have changed, but one thing still remains the same: our commitment to making only the highest quality woodworking tools.



OUR BRANCHES



Pesaro, Italy



Udine, Italy



Greensboro, United States



Valencia, Spain

OUR TOOLS So, what does it take to make a CMT tool? Like all things of quality, it's not only what you do but how you do it. And anyone who works wood knows that you get out of a piece only what you put into it, and it is no different when manufacturing a tool. You choose your designs and materials carefully and you work using all of your skill and know-how. You'll be happy to know that's what we do at CMT too.

OUR TRADEMARK COLOR ORANGE

As the story goes, we began small. We also put orange color surface coating on our tools, then we put our tools on the market and soon our orange tools were all over the world. Now, any woodworker anywhere in the world can tell you that orange tools means CMT, and that CMT means quality. Here at CMT we know we produce quality. You should too. That's why we have trademarked the color orange on woodworking tools - it's your guarantee that you are getting a genuine high-quality CMT product.

DESIGN

Everything starts with a clear idea and having the potential to express it. We have both. At CMT, our technical department uses the best of both worlds - computer technology and hands-on experience - to engineer and design each tool so that it performs flawlessly each time you use it, and to guarantee that you'll be using it for a long, long time.

MATERIALS

Turning a design into a finished product means finding the right material that will do the job and that lives up to the specifications set out in the design - quality performance from the final product depends on it. When it comes to selecting raw materials, we don't cut corners.

At CMT, we know that high quality tools come only from high quality raw materials, so we use only solid bar stock steel and specially formulated micrograin carbide to manufacture our bits and blades.



Loading the automated multi-axis CNC sharpening machines.

MANUFACTURING

Like we said, it's not just what you do but how you do it. Over the years we have continuously invested in the latest technology in CNC machining equipment and innovative software to manufacture our tools. The result is that now our entire manufacturing process, from turning and milling the steel shanks to brazing and sharpening the carbide cutting tips, is completely automated. And since a machine is only as intelligent as the person using it, everything is operated by specifically trained operators.

THE FINAL TOUCH

A tool simply wouldn't be a CMT tool if it didn't have the trademark orange color non-stick P.T.F.E. coating on it. This unique industrial strength surface coating is designed to withstand the physical stresses the tool undergoes during use while protecting it from residue build-up and burning. And we really like the orange color too.

QUALITY CONTROL

Nobody's perfect, but we're trying. CMT uses rigorous quality control programs and the latest generation machining equipment to ensure that each bit has been manufactured with precision and accuracy and that it will give the long-lasting performance you expect from a **CMT ORANGE TOOL**. Our tools are manufactured in compliance with European Standard EN 847 published and enforced by the CEN (European Committee for Standardisation).



WE RECYCLE

CMT filters and purifies its water using a reverse osmosis system located inside the plant. Also the oil used in grinding and machining our tools must be clean and absolutely free of contaminants. Clean oil, after enough use, gets dirty, so we filter and reprocess dirty oil on the premises. This is our way of guaranteeing the quality of the oil we use, as well as contributing to help protect the environment.

LOGISTICS & SERVICES

CMT offers a wide product range with over 7000 different standard tools, but that still isn't enough to achieve 100% customer satisfaction. It's a top priority to process orders and ship the same day. That's why CMT factories worldwide are equipped with 20+ automated vertical storage systems programmed to expedite and simplify order and delivery.

The tools you need, in-stock and ready for prompt shipment within 24 hours. What does this translate to for customers? Quick and efficient service exceeding customer satisfaction and branding our success.



Pesaro, Italy

Greensboro, United States

OUR CHANNELS



www.cmtorangetools.com



www.youtube.com/user/cmtorangetools



www.facebook.com/cmt.italy











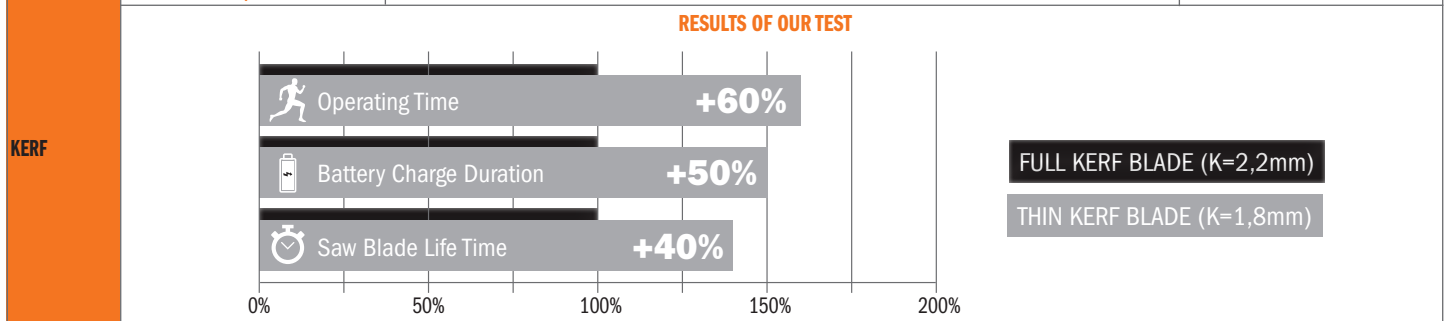

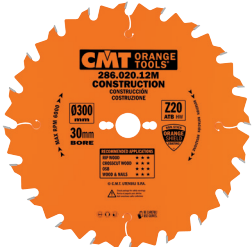



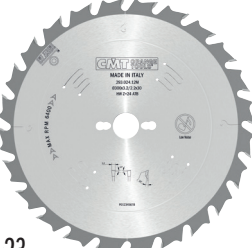

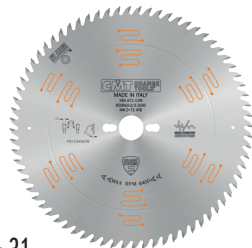

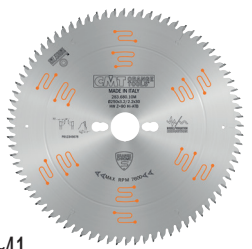
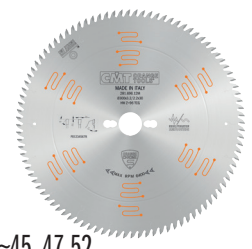



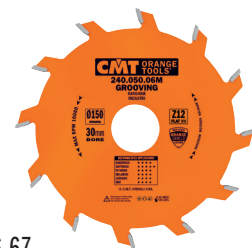



www.instagram.com/cmt_orangetools

Maximize Your HW Saw's Performance



BLADE RANGE	ORANGE CHROME®	XTREME	INDUSTRIAL		ITK PLUS®
PERFORMANCE	★★★★★	★★★★★	★★★★★	★★★★★	★★★★
PACKAGING	CARTON BOX + COLORED LABEL		CARTON BOX	CARTON BOX + COLORED LABEL	PLASTIC CLAMSHELL
STEEL PLATE	LASER-CUT PREMIUM QUALITY STEEL PLATE BODY Made with 46-48 HRC premium quality harmonic steel from Germany and laser-cut to perfection providing tighter tolerances translating to longer life and accurate cutting ability.			LASER-CUT HIGH QUALITY STEEL PLATE BODY Made with 44 HRC high quality steel and laser-cut to ensure longer life and precision cutting.	
EXPANSION SLOTS	LASER-CUT HEAT EXPANSION SLOTS Engineered to allow the blade to resist deformation from increases in temperature due to cutting applications and centrifugal forces.				
SOUND DAMPENING SLOTS	LASER-CUT SOUND DAMPENING SLOTS POLYMER-FILLED Slots filled with sound-dampening polymer reduce vibrations and noise by 25% compared to blades without it.*	LASER-CUT SOUND DAMPENING SLOTS Slots reduce vibrations and noise by 10% compared to blades without it. *This feature improves cut quality and extends blade life. *In full compliance with National Noise Emission Standards and Regulations.			
TENSIONING RING	TENSIONING RING A visible tensioning ring on blade body provides stability during the cut and perfect concentricity during rotation. For improved performance, tensioning is fine-tuned according to machine/application.			×	×
BRAZING	TRI-METAL BRAZING Silver-Copper-Silver Tri-Metal Brazing prevents carbide from breaking during the cooling process and allows teeth to withstand high stress and impact especially when cutting harder woods and composite materials.	SILVER BRAZING Silver Alloy Brazing prevents carbide from breaking during the cooling process and allows teeth to withstand high stress and impact especially when cutting harder woods and composite materials.			
CARBIDE TEETH	INDUSTRIAL CHROME CARBIDE Cutting teeth are made from a specially formulated chrome carbide which stays sharper longer by reducing cutting edge abrasion, improving cut quality and tool life.	INDUSTRIAL SINTERHIP HI-DENSITY CARBIDE The SINTERHIP sintering process (Hot Isostatic Pressing) uses high temperature (up to 3500°F) and high pressure (up to 1500 psi) to fully consolidate carbide thereby resulting in a porosity-free product ensuring longer cutting life over traditional carbide and less risk of breakages.			
SHARPENING	PRECISION MIRROR FINISH SHARPENING Each tooth is precision ground on a multi-axis CNC machine creating perfect edge angles that provide extra-clean cutting performance and extended life. Featuring less than 0.25 µm Rmax in edge roughness.	PRECISION SHARPENING Each tooth is precision ground on a multi-axis CNC machine creating perfect edge angles that provide extra-clean cutting performance and extended life. Featuring less than 0.35 µm Rmax in edge roughness.		SHEAR ANGLE SHARPENING The shear angle grinding, on the front face of the teeth, reduces the required cutting force thereby allowing for smoother cutting.	
COATING	ORANGE CHROME® COATING - Protects the tool against corrosion, rust and accumulation of resin and residues. - Guarantees longer tool life. - Lower power absorption by motor. - Smoother blade movement throughout cutting operation. - Tool maintenance is fast and easy.	HARD LAQUERING Protects against corrosion and rust.			ORANGE SHIELD® NON-STICK PTFE COATING - Protects against corrosion and rust. - Reduces resin and residue build-up. - Reduces overheating and blade drag. - Improves performance and cutting life.
BALANCING	CMT XTREME BALANCING™ This system allows for extremely accurate dynamic balancing of the blade, several orders of magnitude above and beyond that which is currently available in the marketplace. *TRADEMARK & INT. PAT. PEND.	CMT XTREME BALANCING* This system allows for extremely accurate dynamic balancing of the blade, several orders of magnitude above and beyond that which is currently available in the marketplace. *TRADEMARK & INT. PAT. PEND.		×	×



<p>CONSTRUCTION</p>  <p>10</p>	<p>DEMOLITION</p>  <p>11</p>	<p>CONTRACTOR</p>  <p>14-15</p>	<p>MULTI-RIP</p>  <p>16-19</p>	WOOD	
<p>RIPPING</p>  <p>20-23</p>	<p>RIPPING & CROSSCUT</p>  <p>24-27</p>	<p>FINISHING</p>  <p>28-31</p>	<p>FINE FINISHING</p>  <p>32-37</p>		
<p>ULTRA FINE FINISHING</p>  <p>38-41</p>	<p>LAMINATED & CHIPBOARD</p>  <p>42-45, 47, 52</p>	<p>LAMINATED & HPL</p>  <p>46</p>	<p>PANEL SIZING & DPX</p>  <p>48-49</p>		
<p>SCORING & DP SCORING</p>  <p>50-52</p>	<p>DADO</p>  <p>64-65</p>	<p>GROOVING</p>  <p>66-67</p>	<p>GROOVING SYSTEM & BISCUIT JOINER</p>  <p>68-69</p>		
<p>NON-FERROUS & PLASTIC</p>  <p>54</p>	<p>NON-FERROUS & MELAMINE</p>  <p>55</p>	<p>NON-FERROUS & MELAMINE</p>  <p>56</p>	<p>NON-FERROUS & MELAMINE ITK®</p>  <p>57</p>	NON-FERROUS	
<p>HSS - METAL & STEEL</p>  <p>58-59</p>	<p>HSS - METAL & STEEL (TiCN)</p>  <p>59</p>	<p>METAL & STEEL</p>  <p>60-61</p>	<p>STAINLESS STEEL</p>  <p>62</p>		METAL & STEEL
<p>ANGLE GRINDER</p>  <p>12</p>	<p>DP - ULTRA-HARD & MULTI-MATERIALS</p>  <p>13, 53</p>	<p>SOLID SURFACE & PLASTICS</p>  <p>63</p>	<p>CLEARING GRASS, BUSHES, SMALL TREES</p>  <p>70</p>		MULTI-MATERIALS

NEW PRODUCTION FACILITY IN UDINE, ITALIA

We are honored to announce the appointment of Piergiorgio Pozzo as Head of the Saw Blade Division at our new, highly technological production plant, based in Udine.

Mr. Pozzo's experience stems from a long-standing commitment to and success in the development of high-performance industrial blades.

Thanks to a rich and extensive knowledge in the field, Mr. Pozzo and his team have successfully patented a brand-new saw blade line of outstanding quality.



QUALITY ACCORDING TO CMT

Quality can take on different meanings, at times it may relate to the appearance of a product, other times to the number of features or the materials used to make it and so on. Circular saw blades are technical items, tools dedicated to the realization of intermediate workings that if carried out impeccably, enable the manufacturing of the highest-quality finished products with the best production efficiency. Based on this principal, CMT manufactures saw blades using the functional quality concept, this being that every detail of the saw blade, from its design to the choice of materials to its manufacturing cycle, is finalized to give the best performance in the true-life use of the tool. As such, the features of our saw blades are always functional and are found on the product only if and when they bring a true benefit to reaching the established performance target. Should any of the saw blade features fail to do so they will be purposely omitted; the same applies to the tools' manufacturing work cycle which in turn makes it possible for CMT to focus its resources and on what really represents value for the user. The quality embedded in our products is the result of a school of thought which is shared and embraced by the people who make them, and this culture is relentlessly cultivated and improved. Quality at CMT also means respect for people and the Earth.

STEEL PLATE

The body of a blade is an integral part of blade design; cutting quality and longevity depend on it. We use only the highest quality steel available, so durable and tough that it will not only withstand heavy workloads, but also be flexible enough to bend without breaking.

LASER CUT

All our blanks are laser cut; this allows us to use harder harmonic steels for the blade bodies, which in return generates extremely rigid and stable saw blades, guaranteeing perfect flatness. In addition, we are able to engineer quieter tools using a very narrow laser beam to cut expansion and vibration dampening slots.

EXPANSION SLOTS

Engineered to allow the blade to resist deformation from increases in temperature due to cutting applications or centrifugal forces.

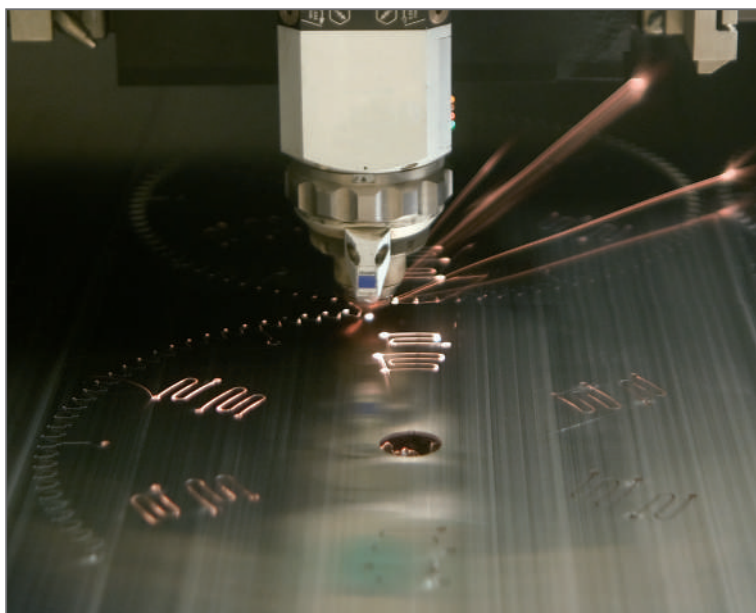

LASER-CUT SLOTS FILLED WITH SOUND-DAMPENING POLYMER

Slots filled with sound-dampening polymer reduce vibrations and noise by 25% compared to blades without it (only the "Orange Chrome" series feature polymer-filled sound dampening slots). This feature improves cut quality and extends blade life.

In full compliance with National Noise Emission Standards and Regulations. (Expansion slots not enhanced by polymer filling, reduce vibration and noise by 10%).

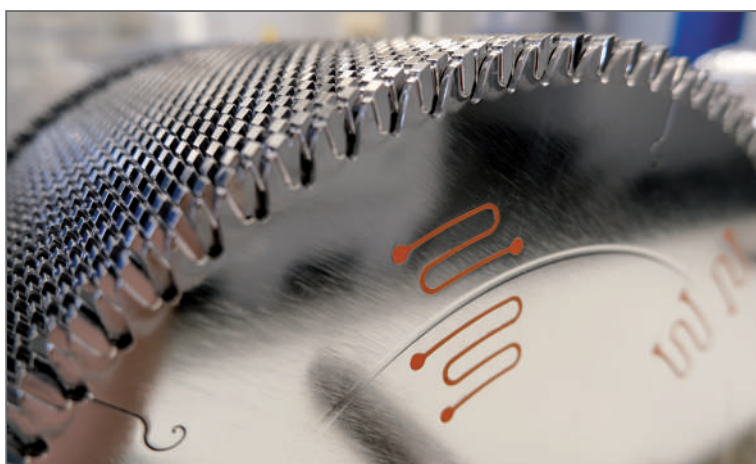

CMT XTREME BALANCING*

* TRADEMARK & INT. PAT. PEND.

This system allows for extremely accurate dynamic balancing of the blade, several orders of magnitude above and beyond that which is currently available in the marketplace.

Each blade undergoes rigorous assessment and only in the event that micro imbalance is detected will the appropriate correction holes be applied.

You may find 1 to 5 micro balancing holes on your blade, depending on the degree of micro imbalance (fig.1). When in perfect balance, a single incision will appear on the blade as proof of balance (fig.2).

These holes will have no effect on the technical properties of the blade during use (such as an increase in noise**, chip build-up at the correction site, etc.).

This translates to precise cutting, longer blade life, reduced vibration and noise, and less wear and tear on your machine components.

**Results are based on tests conducted by an independent laboratory.

These results are available for download on our website.

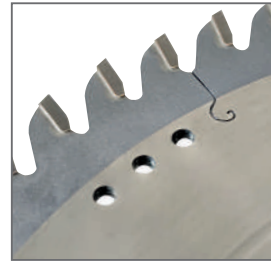
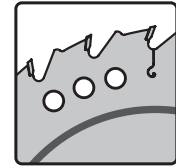

Fig. 1
Example of balancing holes.



Fig. 2 Example of inspected blade already in perfect balance.

**CMT XTREME
BALANCING**



TENSIONING RINGS & FLATTING

To ensure maximum performance, flattening and plate tensioning processes are performed. Every single blade is subject to a flattening process in order to achieve the highest flatness tolerance. The blade body then undergoes tensioning in order to enhance stiffness and stability.

A well-marked and visible ring is applied to the blade body by means of compression and with a predetermined force linked to the intended application and working conditions of each blade.

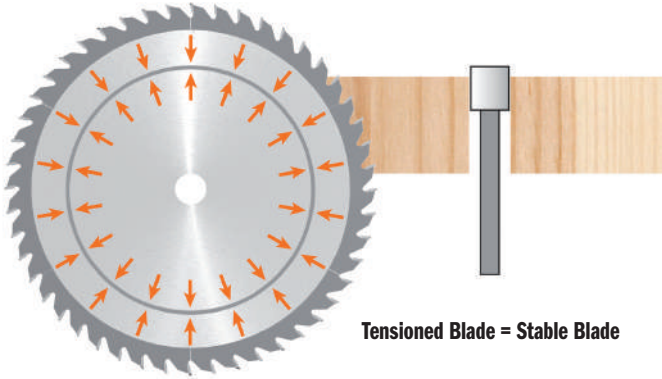

Tensioned Blade = Stable Blade

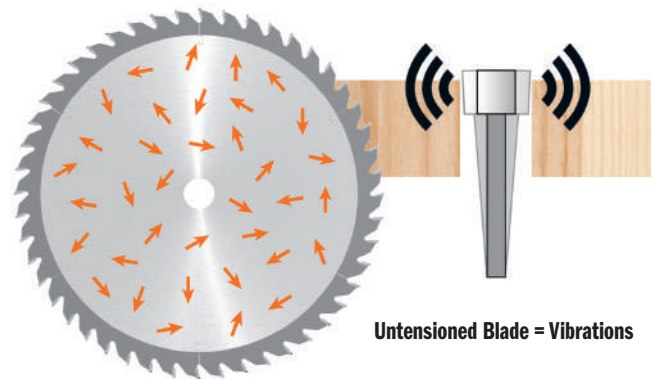

Untensioned Blade = Vibrations

CARBIDE TEETH

Tips require optimum quality carbide. Different applications call for different grades. Our Research and Development Team has evaluated and tested carbide grades and tracked their yield on performance both in house and in the field. We have access to the widest range in the world and only use top premium quality carbides.

TRI-METAL BRAZING

Brazing is the process of attaching a hard metal plate to the steel body of the blade. This is performed by using a bonding metal, which once melted, acts as a binder between the two parts. The bonding material used for brazing is a trimetallic alloy formed by silver, copper and silver, which not only serves to effectively attach the two parts together but whose fundamental properties create a shock-absorber effect protecting the cutting edges during routing operations.

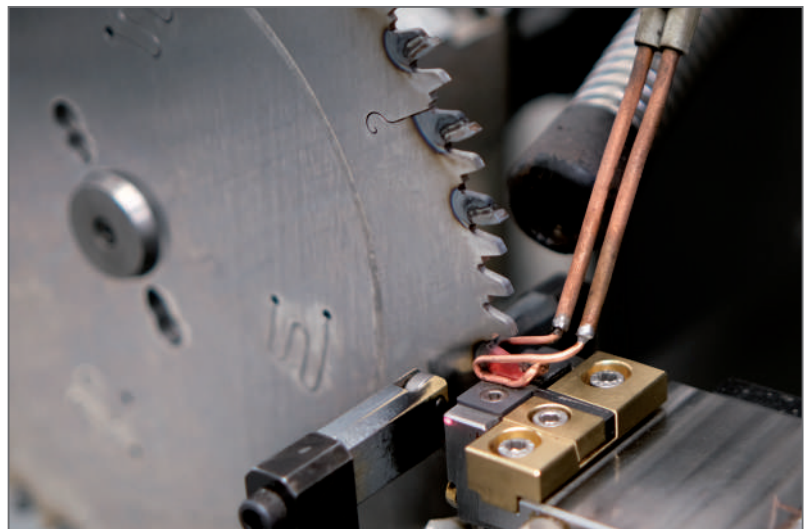
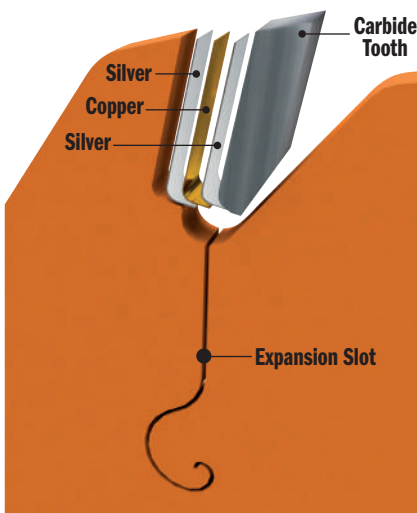

CMT Orange Tools

SHARPENING & CUTTING ANGLES

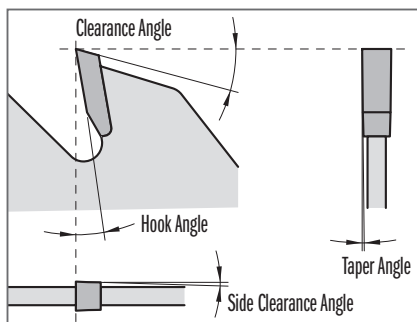

Sharpening is imperative to the production process of the blade and equally important with respect to the project in mind and material in use. Fully automated and numerically controlled grinding machines tooled with extra-fine-grained diamond wheels allow any type of angle and shape of the tooth. The right choice of these parameters will guarantee cutting edge lifetime and ultimately the best finish on the finished part.



COATING

Quality coatings can be extremely effective in certain applications. CMT uses the following:



ORANGE SHIELD® COATING: a registered and trademarked non-stick protective coating bearing our characteristic orange color. A technopolymer (P.T.F.E. is spray-applied to the blade body then baked to enhance its protective properties. Chemical compounds cannot attach this coating, it remains insoluble in water and solvents, is completely non-stick and diffuses and disperses heat.



ORANGE CHROME® COATING: this is a coating composed of a thin layer of chromium, which is electrolytically deposited on the blade in order to increase wear resistance when in contact with highly abrasive material. Surface hardness increases considerably, guaranteeing long-life and incredible resilience to corrosion and rust.

LASER MARKING & SCREEN PRINTING

All CMT blades are identifiable by means of a latest generation indelible laser marking or multicolored screen-printing, a sophisticated automated technology that guarantees striking and versatile results.

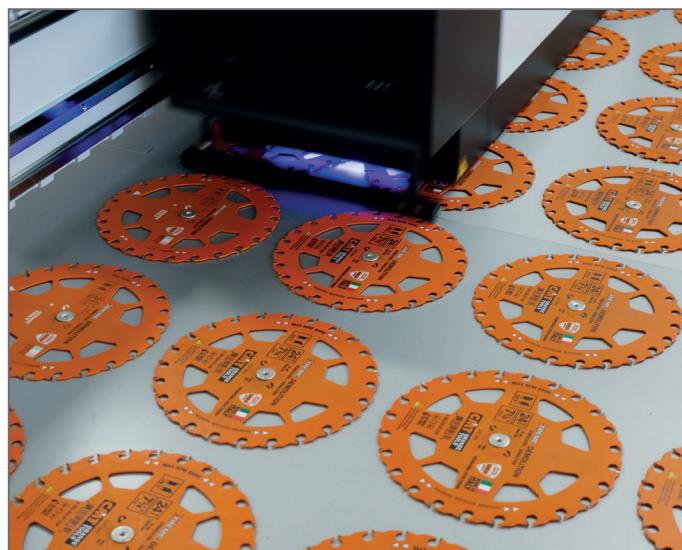

FINAL TESTING AND QUALITY CONTROL

Following design and manufacturing phases, each new model is tested to ensure maximum performance during the work phase. The entire production process is subject to meticulous quality controls using conventional and sophisticated measuring system.



NEW PACKAGING

- Blade packaging is made from strong and sturdy cardboard, reusable and environmentally friendly.
- Package information updated in 12 languages.
- New colored labels offer useful technical information such as application, materials and machine compatibility.



HOW TO CHOOSE A BLADE IN THE NEW CMT CATALOGUE

1

WHAT'S THE MATERIAL YOU WANT TO CUT?

- WOOD**
- NON-FERROUS**
- METAL & STEEL**
- MULTI-MATERIALS**

See table on page 5

2

WHAT'S THE APPLICATION?

- RIPPING
- RIPPING & CROSSCUT
- FINISHING
- FINE FINISHING
- ULTRA FINE FINISHING
- etc

See table on page 5

3

WHAT ARE THE PERFORMANCE EXPECTATIONS?



4

WHAT MACHINE ARE YOU USING?

BASED ON YOUR MACHINE, CHOOSE THE APPROPRIATE BLADE:

- DIAMETER (D)
- BORE (B)

SUGGESTIONS FOR CHOOSING THE RIGHT BLADE:

HOOK ANGLE α

- Wood, Solid Surface ($\alpha = 10^\circ \sim 25^\circ$)
- Chipboard, MDF, Plywood, Laminate, Plastic ($\alpha = 5^\circ \sim 15^\circ$)
- Chipboard, MDF, Non-Ferrous, Metals ($\alpha = 0^\circ \sim 10^\circ$)
- Metals, Non-Ferrous, Plastic, Laminate ($\alpha = -5^\circ \sim -15^\circ$)

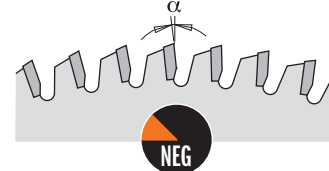
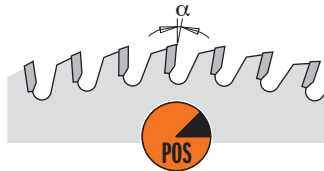

TEETH SHAPE

- Wood, Chipboard, MDF, Plywood

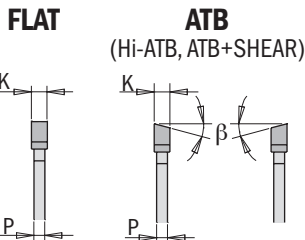

- Laminate, Chipboard, MDF, Plywood, Plastic TRESPA®

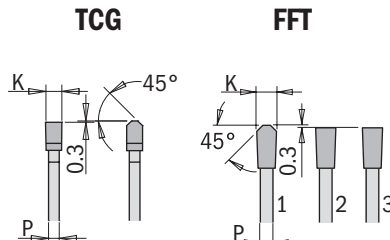

- Metals

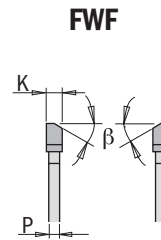

- Special Application/Materials

- HDF**
- FLAT+ATB**
- CO+FLAT**
- MTCG**
- MATB**
- HR**

SUGGESTIONS FOR BLADE USE:

In order to achieve the best cut possible, that is without modifying the predetermined angle of entry/exit, it is important that the portion of the blade (**H**) which extends beyond the workpiece during the cut, be close to equal to the height of an entire tooth (approx. 8/10mm). To improve the finish, it is possible to make small adjustments by increasing or decreasing this height.

The number of teeth simultaneously engaged in cutting the material (**Teeth Cutting or Z_p**) must be constant as the thickness (**S**) of the material varies.

As with $Z_p < 3$, the cutting quality is not guaranteed.

With the same diameter, and when cutting thicker material, ensure to use a blade with less teeth (or with a greater Pitch **P**) or vice versa ($S = [P \times Z_p] / 1.414$).

Thin blades are suitable for thinner materials. They also require less power during operation, and are ideal for battery-operated machines.

Thick blades, which are more robust, are suitable for precision cutting in thicker materials but obviously require more power.

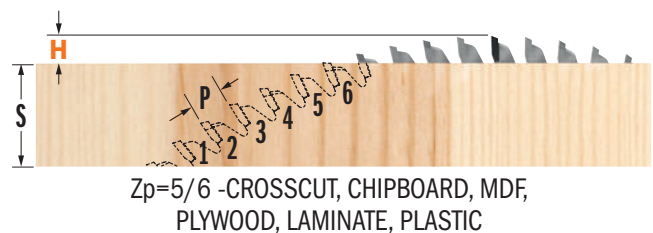
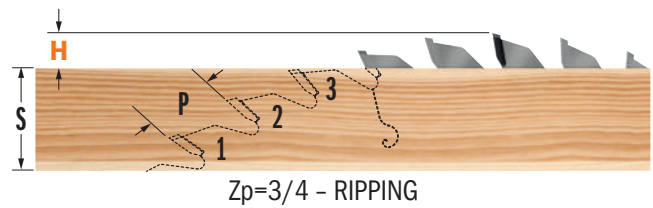

The blade Pitch (**P**), or the distance between each tooth, is calculated in the following way:

$$P = \frac{D \times 3,14}{Z} \quad \begin{matrix} D = \text{Blade Diameter (mm)} \\ Z = N^\circ \text{ of Teeth} \end{matrix}$$

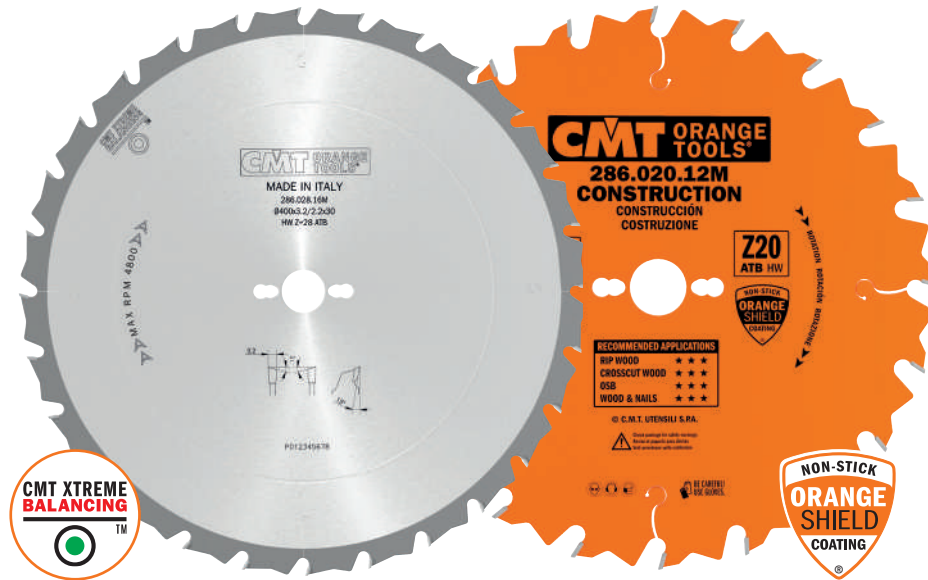

286



WOOD

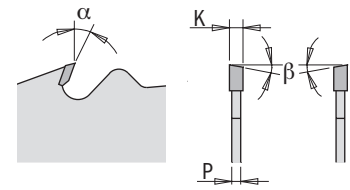

Images are not in scale with each other.

MACHINES



Blade diameter compatibility is contingent on machine type.

APPLICATIONS

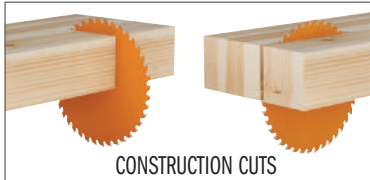

MATERIALS

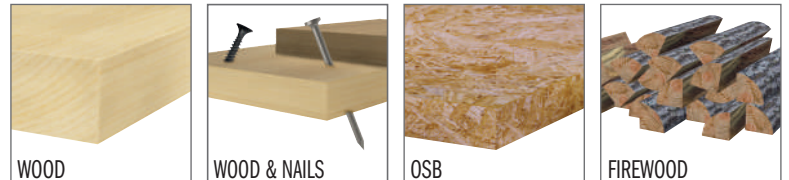

For specific details regarding suggested materials, please check blade label.

286 INDUSTRIAL



D mm	B mm	PIN HOLE	Z	K mm	P mm	α	β	5	ORDER NO.
250	30	COMBI3	16	2,8	1,8	15°	5° ATB	5	286.016.10M
300	30	COMBI3	20	2,8	1,8	15°	5° ATB	5	286.020.12M
300*	30	COMBI3	48	3,2	2,2	15°	10° ATB	5	286.048.12M
315	30	COMBI3	24	3,2	2,2	15°	5° ATB	5	286.024.13M
350	30	COMBI3	24	3,2	2,2	15°	5° ATB	5	286.024.14M

* Without limiter

286 XTREME



D mm	B mm	PIN HOLE	Z	K mm	P mm	α	β	1	ORDER NO.
400	30	COMBI3	28	3,2	2,2	15°	5° ATB	1	286.028.16M
450	30	2/10/60	32	3,8	2,8	15°	5° ATB	1	286.032.18M
500	30	2/10/60	36	3,8	2,8	15°	5° ATB	1	286.036.20M
550	30	2/10/60	40	4,2	3,2	15°	5° ATB	1	286.040.22M
600	30	2/10/60	40	4,2	3,2	15°	5° ATB	1	286.040.24M
700*	30	2/10/60	46	4,4	3,2	15°	5° ATB	1	286.046.28M

* INDUSTRIAL LINE

SHOP TIPS: Use our reduction ring from 30 to 25mm order n. 299.225.00 (for saw blades Ø250-300-315)
Use our reduction ring from 30 to 25mm order n. 299.228.00 (for saw blades Ø350 and larger)

286 XTREME DEMOLITION



INNOVATIONS
INTERNATIONAL PATENT PENDING



EXCLUSIVE SECURED TOOTH GEOMETRY
- BETTER HANDLES IMPACT WITH NAILS
- CUTS MORE NAILS THAN COMPETITORS

Engineered to ensure the longest tool life under the most demanding conditions. Tips are brazed deep inside the blade plate for superior nail impact resistance.



LOW MASS PLATE DESIGN
Patented design that reduces blade mass minimizes heat and substantially increases cutting efficiency with cordless and corded saws. More cuts. Less battery.

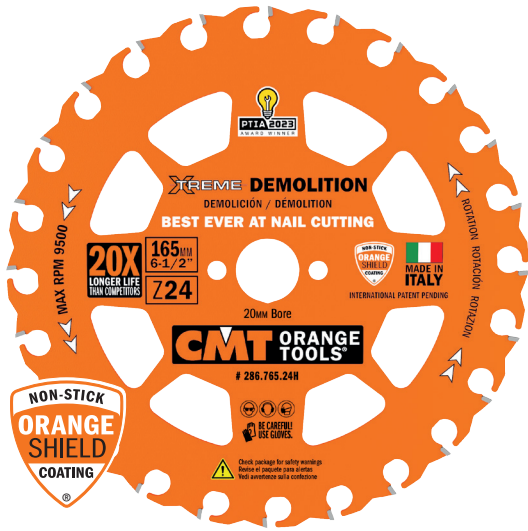

BEST EVER AT NAIL CUTTING

MACHINES



Blade diameter compatibility is contingent on machine type.

MATERIALS

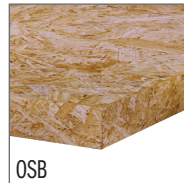

2023 PRO TOOL INNOVATION AWARDS
CIRCULAR SAW BLADE WINNER
"RECOGNITION FOR EXCELLENT VALUE,
ADVANCED FEATURES AND INNOVATION"
www.protoolinnovationawards.com



Watch the video on
YouTube



D mm	B mm	PIN HOLE	Z	K mm	P mm	α	β		ORDER NO.
160	20	2/6/32	24	2,3	1,2	5°	5° ATB	1	286.760.24H ●
165	20	2/6/32	24	2,3	1,2	5°	5° ATB	1	286.765.24H
190	30	2/7/42	24	2,3	1,2	5°	5° ATB	1	286.790.24M

● Ideal for **FESTOOL**® & others

Multi-Materials Carbide Wheel for Angle Grinder

new

CMT ORANGE TOOLS

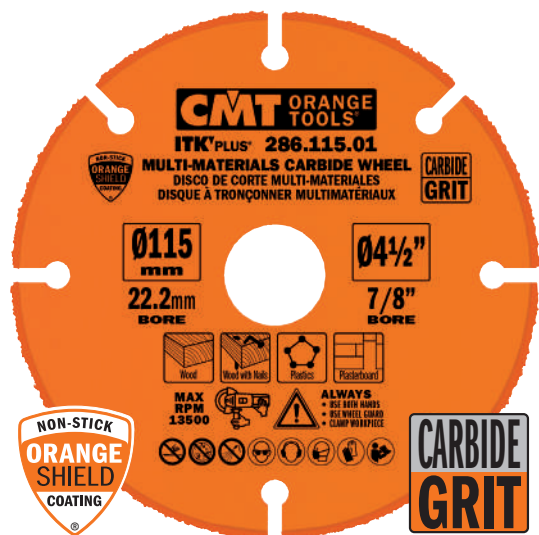

286 ITK PLUS®



MULTI-MATERIALS

D mm	B mm		ORDER NO.
115	22,2 (+9,5+15,87)	10	286.115.01
125	22,2 (+20+15,87)	10	286.125.01
230	22,2	5	286.230.01

MACHINES



ANGLE GRINDER



MINI CORDLESS CIRC. SAW



Blade diameter compatibility is contingent on machine type.

MATERIALS

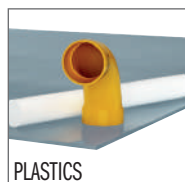

Multi-Materials Diamond Dry Wheel for Angle Grinder

new



286.61 ITK PLUS®



MULTI-MATERIALS

D mm	B mm		ORDER NO.
115	22,2 (+9,5+15,87)	10	286.115.61
125	22,2 (+20+15,87)	10	286.125.61

MACHINES



ANGLE GRINDER



MINI CORDLESS CIRC. SAW



Blade diameter compatibility is contingent on machine type.

MATERIALS





236 ITK PLUS

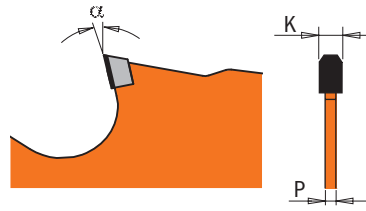

60X
LONGER LIFE
THAN CARBIDE

PCD DP LONG LIFE
 PERFORMANCE
 MULTI-MATERIALS

MACHINES

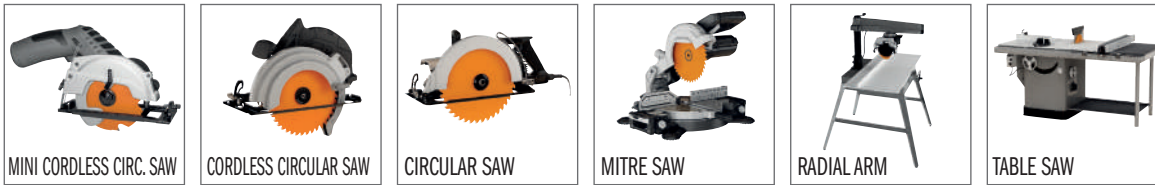

Blade diameter compatibility is contingent on machine type.

MATERIALS



IDEAL FOR:
 SWISSPEARL®, FERMACELL®,
 IVARPLANK®,
 HARDIEPLANK®,
 HARDIEPANEL®,
 CORIAN®, DUROPLAST®,
 FORMICA®

D mm	B mm	PIN HOLE	Z	K mm	P mm	α	β		ORDER NO.
85 *	15	-	6	1,8	1,4	12°	TCG	10	236.085.06G
125 *	22,2	-	7	2,0	1,4	5°	TCG	10	236.125.07
160	20	2/6/32	4	2,4	1,8	12°	TCG	10	236.160.04H
160	20	2/6/32	10	2,4	1,8	5°	TCG	10	236.160.10H
165	20 (+15,87)	2/6/32	4	1,8	1,4	12°	TCG	10	236.165.04H
165	20 (+15,87)	2/6/32	10	1,8	1,4	5°	TCG	10	236.165.10H
168	20	2/6/32	10	1,8	1,2	5°	TCG	10	236.168.10H ●
180	20	2/6/32	4	2,4	1,8	12°	TCG	10	236.180.04H
190	30	2/7/42	4	2,4	1,8	12°	TCG	10	236.190.04M
190	30	2/7/42	12	2,4	1,8	12°	TCG	10	236.190.12M
210	30	2/7/42	12	2,4	1,8	12°	TCG	10	236.210.12M
216	30	2/7/42	14	2,4	1,8	12°	TCG	10	236.216.14M
230	30	2/7/42	4	2,4	1,8	12°	TCG	10	236.230.04M
250	30	COMBI3	16	2,4	1,8	12°	TCG	10	236.250.16M
300	30	COMBI3	20	2,4	1,8	12°	TCG	5	236.300.20M

*Non-Silent Blades

● Ideal for **FESTOOL**® & others



K CONTRACTOR®



Designed for construction, remodeling and DIY projects. These blades deliver performance at a very economical price.



PERFORMANCE

WOOD

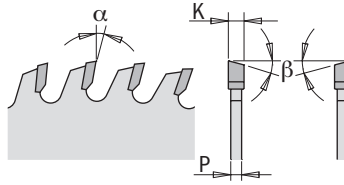

MACHINES



MINI CORDLESS CIRC. SAW



CORDLESS CIRCULAR SAW



CIRCULAR SAW



MITRE SAW



SLIDE MITRE SAW



PORTABLE TABLE SAW



TABLE SAW

Blade diameter compatibility is contingent on machine type.

APPLICATIONS



RIPS

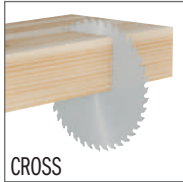

CROSS

For specific details regarding applications, please check blade label.

MATERIALS



WOOD

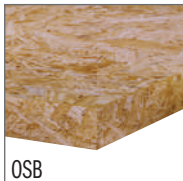

OSB



PLYWOOD



CLAMSHELL



BULK PACK 10 PCS.

DESCRIPTION	D mm	B mm	PIN HOLE	Z	K mm	P mm	α	β		ORDER NO. CLAMSHELL		ORDER NO. BULK PACK 10 PCS.
Finish	86	15	2/6/60	24	1,5	1,0	12°	5° ATB	10	K02403		
General Purpose	136	20	-	18	1,5	1,0	15°	15° ATB			30	K13618H-X10
General Purpose	160	20	2/6/32	24	2,2	1,4	15°	15° ATB	10	K16024H	30	K16024H-X10
Finish	160	20	2/6/32	40	2,2	1,4	15°	15° ATB	10	K16040H	30	K16040H-X10
General Purpose	165	20	2/6/32	24	1,7	1,1	15°	15° ATB	10	K16524H	30	K16524H-X10
Finish	165	20	2/6/32	40	1,7	1,1	15°	15° ATB	10			K16540H-X10
General Purpose	190	30	2/7/42	24	2,2	1,4	20°	10° ATB	10	K19024M	30	K19024M-X10
Ripping	216	30	2/7/42	24	2,4	1,6	-5° Neg.	15° ATB	10	K21624M	30	K21624M-X10
Finish	216	30	2/7/42	48	2,4	1,6	-5° Neg.	15° ATB	10	K21648M	30	K21648M-X10
General Purpose	250	30	COMBI3	40	2,6	1,8	15°	10° ATB	10	K25040M	20	K25040M-X05*

* BULK PACK 5 PCS.



K CONTRACTOR®



WOOD

CLAMSHELL COMBO PACK

3 pcs. CLAMSHELL COMBO PACK

Ø160mm Bore 20mm

DESCRIPTION	SET CONTAINS	D mm	B mm	PIN HOLE	Z	K mm	P mm	α	β		ORDER NO. CLAMSHELL
General Purpose	K16024H (1 pc.)	160	20	2/6/32	24	2,2	1,4	15°	15° ATB	10	K160H-X03
Finish	K16040H (2 pcs.)	160	20	2/6/32	40	2,2	1,4	15°	15° ATB		

3 pcs. CLAMSHELL COMBO PACK

Ø190mm Bore 30mm

DESCRIPTION	SET CONTAINS	D mm	B mm	PIN HOLE	Z	K mm	P mm	α	β		ORDER NO. CLAMSHELL
General Purpose	K19024M (2 pcs.)	190	30	2/7/42	24	2,2	1,4	20°	10° ATB	10	K190M-X03
Finish	K19040M (1 pc.)	190	30	2/7/42	40	2,2	1,4	15°	10° ATB		

3 pcs. CLAMSHELL COMBO PACK

Ø216mm Bore 30mm

DESCRIPTION	SET CONTAINS	D mm	B mm	PIN HOLE	Z	K mm	P mm	α	β		ORDER NO. CLAMSHELL
Ripping	K21624M (1 pc.)	216	30	2/7/42	24	2,4	1,6	-5° Neg.	15° ATB	10	K216M-X03
Finish	K21648M (2 pcs.)	216	30	2/7/42	48	2,4	1,6	-5° Neg.	15° ATB		

2 pcs. CLAMSHELL COMBO PACK

Ø250mm Bore 30mm

DESCRIPTION	SET CONTAINS	D mm	B mm	PIN HOLE	Z	K mm	P mm	α	β		ORDER NO. CLAMSHELL
Ripping	K25024M (1 pc.)	250	30	COMBI3	24	2,6	1,8	20°	10° ATB	10	K250M-X02
General Purpose	K25040M (1 pc.)	250	30	COMBI3	40	2,6	1,8	15°	10° ATB		

2 pcs. CLAMSHELL COMBO PACK

Ø305mm Bore 30mm

DESCRIPTION	SET CONTAINS	D mm	B mm	PIN HOLE	Z	K mm	P mm	α	β		ORDER NO. CLAMSHELL
General Purpose	K30540M (1 pc.)	305	30	COMBI3	40	2,8	2,0	-5° Neg.	10° ATB	5	K305M-X02
Finish	K30560M (1 pc.)	305	30	COMBI3	60	2,8	2,0	-5° Neg.	10° ATB		

DP - Ultra-Hard Materials - LONG LIFE



MACHINES



K CONTRACTOR®



MULTI-MATERIALS

MATERIALS

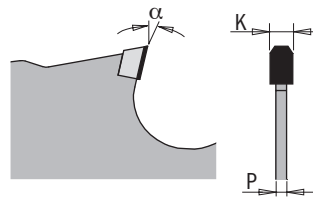

IDEAL FOR:
 SWISSPEARL®, FERMACELL®, IVARPLANK®,
 HARDIEPLANK®, HARDIEPANEL®,
 CORIAN®, DUROPLAST®, FORMICA®

DESCRIPTION	D mm	B mm	PIN HOLE	Z	K mm	P mm	α	β		ORDER NO. CLAMSHELL
Multi-Materials	160	20	2/6/32	10	2,4	1,8	5°	TCG	10	K160-10HD

Multi-Rip with Rakers - THIN KERF



280 INDUSTRIAL

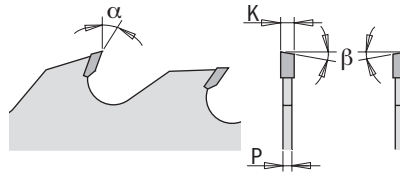

HW MEC

★ ★ ★ ★ ★

PERFORMANCE

WOOD

TECHNICAL DETAILS:

The rakers prevent contact between the steel plate body and the material in use.

Thin Kerf minimises materials wastes.

MACHINES





Blade diameter compatibility is contingent on machine type.

APPLICATIONS



MATERIALS



D mm	B mm	KEY WAY 	PIN HOLE 	Z+V	K mm	P mm	T ₁ mm	α	β		ORDER NO.
180	40		-	21+3	2,5	1,8	30	18°	FLAT	1	280.021.07S
200	40		-	21+3	2,5	1,8	35	18°	FLAT	1	280.021.08S
250	70	21 x 5	-	20+4	2,7	1,8	50	18°	10° ATB	1	280.020.10V
250	80	13 x 5	-	20+4	2,7	1,8	50	18°	10° ATB	1	280.020.10W
300	70	21 x 5	-	24+4	2,7	1,8	60	18°	10° ATB	1	280.024.12V
300	80	13 x 5	-	24+4	2,7	1,8	60	18°	10° ATB	1	280.024.12W

277 INDUSTRIAL



WOOD

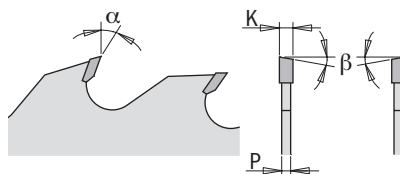

TECHNICAL DETAILS:

The rakers prevent contact between the steel plate body and the material in use.

Mounted on the sides of gang rip saws, these act as shoulder saw blades and ensure stability, reducing vibration under extreme work load.



MACHINES



MULTI-RIP

APPLICATIONS



MULTI-RIP



MATERIALS



HARDWOOD



SOFTWOOD

D mm	B mm	KEY WAY 	PIN HOLE 	Z+V	K mm	P mm	T ₁ mm	α	β		ORDER NO.
300	30		COMBI3	24+4	4,0	2,8	80	18°	10° ATB	1	277.024.12M
300	70	21 x 5	-	24+4	4,0	2,8	80	18°	10° ATB	1	277.024.12V
300	80	13 x 5	-	24+4	4,0	2,8	80	18°	10° ATB	1	277.024.12W
350	30		COMBI3	24+6	4,2	2,8	105	18°	10° ATB	1	277.024.14M
350	70	21 x 5	-	24+6	4,2	2,8	105	18°	10° ATB	1	277.024.14V

Multi-Rip with Rakers



279 INDUSTRIAL



WOOD

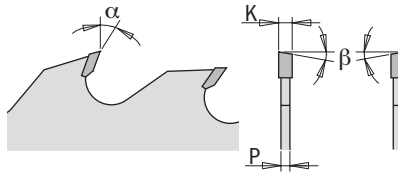

TECHNICAL DETAILS:

The rakers prevent contact between the steel plate body and the material in use.

MACHINES



Blade diameter compatibility is contingent on machine type.

APPLICATIONS

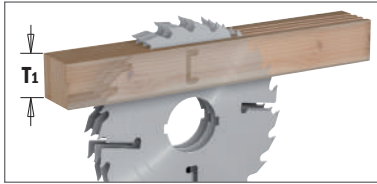

MATERIALS



D mm	B mm	KEY WAY 	PIN HOLE 	Z+V	K mm	P mm	T ₁ mm	α	β		ORDER NO.
250	30		COMBI3	20+4	3,2	2,2	65	18°	10° ATB	1	279.020.10M
250	70	21 x 5	-	20+4	3,2	2,2	65	18°	10° ATB	1	279.020.10V
250	80	13 x 5	-	20+4	3,2	2,2	65	18°	10° ATB	1	279.020.10W
300	30		COMBI3	24+4	3,2	2,2	80	18°	10° ATB	1	279.024.12M
300	60	21 x 5	-	24+4	3,2	2,2	80	18°	10° ATB	1	279.024.12U
300	70	21 x 5	-	24+4	3,2	2,2	80	18°	10° ATB	1	279.024.12V
300	80	13 x 5	-	24+4	3,2	2,2	80	18°	10° ATB	1	279.024.12W
350	30		COMBI3	28+4	3,5	2,5	105	18°	10° ATB	1	279.028.14M
350	60	21 x 5	-	28+4	3,5	2,5	105	18°	10° ATB	1	279.028.14U
350	70	21 x 5	-	28+4	3,5	2,5	105	18°	10° ATB	1	279.028.14V
350	80	14 x 5	-	28+4	3,5	2,5	105	18°	10° ATB	1	279.028.14W
400	30		COMBI3	28+6	4,0	2,8	120	18°	10° ATB	1	279.028.16M
400	70	21 x 5	-	28+6	4,0	2,8	120	18°	10° ATB	1	279.028.16V

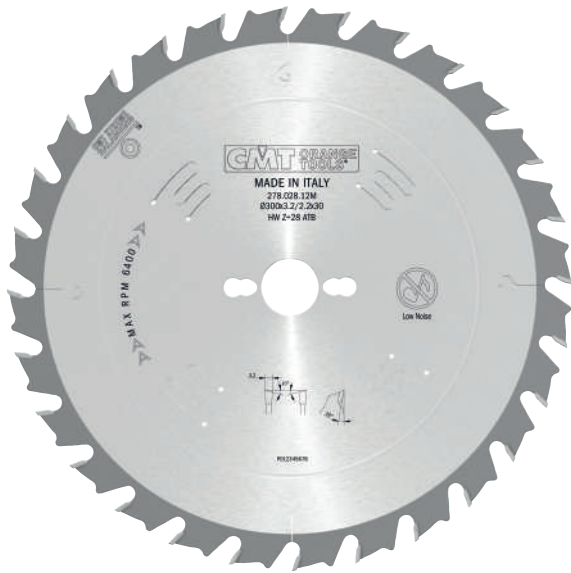

278 XTREME

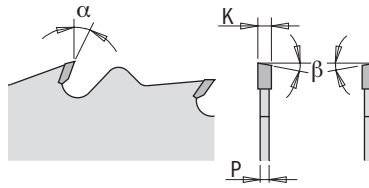

PERFORMANCE

WOOD



MACHINES



SQUARING



MULTI-RIP

Blade diameter compatibility is contingent on machine type.

APPLICATIONS



MULTI-RIP



RIPS



MATERIALS



HARDWOOD



SOFTWOOD

D mm	B mm	KEY WAY 	PIN HOLE 	Z	K mm	P mm	α	β		ORDER NO.
300	30		COMBI3	28	3,2	2,2	18°	10° ATB	1	278.028.12M
300	70	21 x 5	-	28	3,2	2,2	18°	10° ATB	1	278.028.12V
350	30		COMBI3	36	3,5	2,5	18°	10° ATB	1	278.036.14M
350	70	21 x 5	-	36	3,5	2,5	18°	10° ATB	1	278.036.14V

Ripping



WOOD



285 ORANGE CHROME®

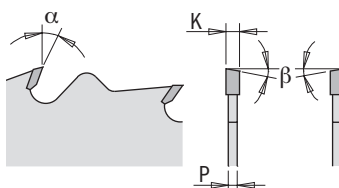

MACHINES



Blade diameter compatibility is contingent on machine type.

APPLICATIONS



MATERIALS



D mm	B mm	PIN HOLE 	Z	K mm	P mm	α	β		ORDER NO.
250	30	COMBI3	24	3,2	2,2	10°	FLAT	1	285.624.10M



285-293 XTREME

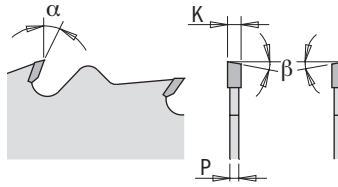

WOOD



MACHINES



Blade diameter compatibility is contingent on machine type.

APPLICATIONS



MATERIALS



D mm	B mm	PIN HOLE 	Z	K mm	P mm	α	β		ORDER NO.
300	30	COMBI3	24	3,2	2,2	20°	10° ATB	1	293.024.12M
300	35	-	24	3,2	2,2	20°	10° ATB	1	293.024.12R
305	30	2/10/60	28	2,8	1,8	20°	10° ATB	1	293.028.22M
315	30	COMBI3	28	3,2	2,2	20°	10° ATB	1	293.028.12M
315	30	COMBI3	36	3,2	2,2	15°	5° ATB	1	285.036.13M
350	30	COMBI3	28	3,5	2,5	20°	10° ATB	1	293.028.14M
350	35	-	28	3,5	2,5	20°	10° ATB	1	293.028.14R
400	30	COMBI3	36	3,5	2,5	20°	10° ATB	1	285.036.16M
450	30	COMBI3	36	3,8	2,8	20°	10° ATB	1	285.036.18M
500	30	COMBI3	44	4,0	2,8	20°	10° ATB	1	285.044.20M



290 INDUSTRIAL

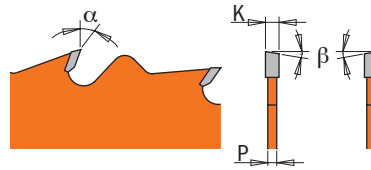

WOOD

MACHINES

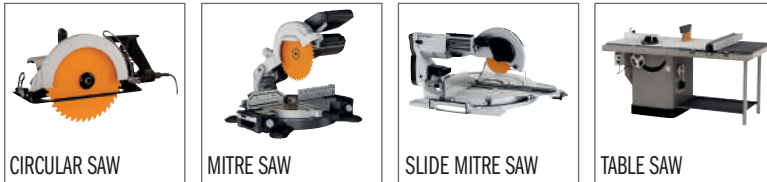

Blade diameter compatibility is contingent on machine type.

APPLICATIONS



MATERIALS



D mm	B mm	PIN HOLE ⊕⊕	Z	K mm	P mm	α	β		ORDER NO.
150	20	-	12	2,4	1,4	20°	10° ATB	10	290.150.12H
160	16	-	12	2,2	1,6	20°	10° ATB	5	290.160.12E ■
160	20 (+16)	2/6/32	12	2,2	1,6	20°	10° ATB	10	290.160.12H ●
180	30	2/7/42	12	2,6	1,6	20°	10° ATB	10	290.180.12M
190	20	2/6/32	12	2,6	1,6	20°	10° ATB	5	290.190.12H ■
190	30 (+20+16)	2/7/42	12	2,6	1,6	20°	10° ATB	10	290.190.12M
200	30	2/7/42	24	2,8	1,8	20°	10° ATB	10	290.200.24M
210	30	2/7/42	24	2,8	1,8	20°	10° ATB	10	290.210.24M ●
216	30	2/7/42	24	2,8	1,8	-5° Neg.	15° ATB	10	290.216.24M ●
220	30	2/7/42	24	2,8	1,8	20°	10° ATB	10	290.220.24M
230	30	2/7/42	24	2,8	1,8	20°	10° ATB	10	290.230.24M ●
235	25	-	24	2,8	1,8	20°	10° ATB	5	290.235.24L ■
235	30 (+25)	2/7/42	24	2,8	1,8	20°	10° ATB	10	290.235.24M
240	30	2/7/42	24	2,8	1,8	20°	10° ATB	10	290.240.24M
250	30	COMBI3	24	2,8	1,8	20°	10° ATB	5	290.250.24M
260	30	COMBI3	28	2,8	1,8	20°	10° ATB	5	290.260.28M ●
270	30	COMBI3	28	2,8	1,8	20°	10° ATB	5	290.270.28M

● Ideal for **FESTOOL®** & others

■ Until stock last



271 ITK PLUS®

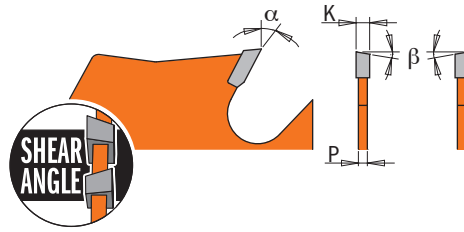

WOOD

MACHINES



MITRE SAW



TABLE SAW

Blade diameter compatibility is contingent on machine type.

APPLICATIONS



RIP

MATERIALS



HARDWOOD



SOFTWOOD



OSB

For specific details regarding suggested materials, please check blade label.

D mm	B mm	PIN HOLE	Z	K mm	P mm	α	β		ORDER NO.
250	30	COMBI3	24	2,4	1,6	20°	10° ATB + 8° Shear	10	271.250.24M
300	30	COMBI3	24	2,6	1,8	22°	10° ATB + 8° Shear	5	271.300.24M

Ripping & Crosscut [General Purpose]



285.6 ORANGE CHROME®



WOOD

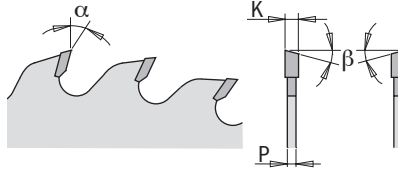

MACHINES



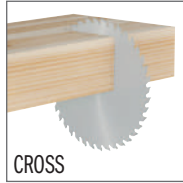

Blade diameter compatibility is contingent on machine type.

APPLICATIONS

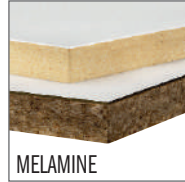

MATERIALS



D mm	B mm	PIN HOLE 	Z	K mm	P mm	α	β		ORDER NO.
250	30	COMBI3	40	3,2	2,2	5°	10° ATB	1	285.640.10M
300	30	COMBI3	48	3,2	2,2	5°	10° ATB	1	285.648.12M
350	30	COMBI3	54	3,5	2,5	5°	10° ATB	1	285.654.14M
400	30	COMBI3	60	3,5	2,5	10°	15° ATB	1	285.660.16M

Ripping & Crosscut [General Purpose]

285-294 XTREME

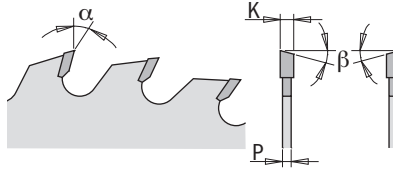

WOOD



MACHINES



APPLICATIONS



Blade diameter compatibility is contingent on machine type.

MATERIALS



For specific details regarding suggested materials, please check blade label.

D mm	B mm	PIN HOLE 	Z	K mm	P mm	α	β		ORDER NO.
250*	20	-	40	3,2	2,2	15°	10° ATB	1	285.040.10H
250	30	COMBI3	40	3,2	2,2	5°	10° ATB	1	285.040.10M
250	35	-	40	3,2	2,2	15°	10° ATB	1	285.040.10R
250	30	COMBI3	48	3,2	2,2	15°	10° ATB	1	285.048.10M
254	30	COMBI3	48	2,4	1,8	-5° Neg.	15° ATB	1	294.048.10M
275	20	-	42	3,2	2,2	15°	10° ATB	1	285.042.11H
300	30	COMBI3	36	3,2	2,2	15°	10° ATB	1	285.036.12M
300*	20	COMBI3	48	3,2	2,2	15°	10° ATB	1	285.048.12H
300	30	COMBI3	48	3,2	2,2	5°	10° ATB	1	285.048.12M
300	35	-	48	3,2	2,2	15°	10° ATB	1	285.048.12R
305	30	2/10/60 + 2/7/42	54	2,8	1,8	-5° Neg.	15° ATB	1	294.054.22M
315*	30	COMBI3	54	3,2	2,2	15°	10° ATB	1	294.054.12M
350	30	COMBI3	54	3,5	2,5	5°	10° ATB	1	285.054.14M
350	35	-	54	3,5	2,5	15°	10° ATB	1	285.054.14R
400	30	COMBI3	48	3,5	2,5	20°	10° ATB	1	285.048.16M
400	30	COMBI3	60	3,5	2,5	10°	15° ATB	1	285.060.16M
450	30	COMBI3	54	3,8	2,8	15°	15° ATB	1	285.054.18M
500	30	COMBI3	60	3,8	2,8	15°	15° ATB	1	285.060.20M
550	30	2/10/60	60	4,2	3,2	10°	15° ATB	1	285.060.22M
600	30	2/10/60	66	4,2	3,2	10°	15° ATB	1	285.066.24M
700*	30	2/10/60	72	4,4	3,2	10°	15° ATB	1	285.072.28M

* INDUSTRIAL LINE

* Non-Silent Blades



285-291 INDUSTRIAL



WOOD

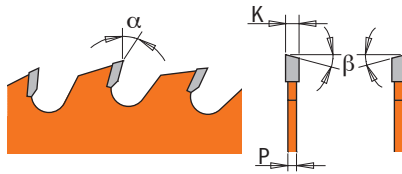

MACHINES



Blade diameter compatibility is contingent on machine type.

APPLICATIONS

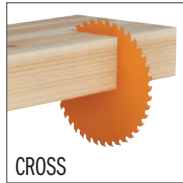

MATERIALS

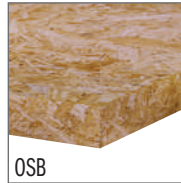

D mm	B mm	PIN HOLE	Z	K mm	P mm	α	β	APPLICATIONS	📦	ORDER NO.
120	20	2/5,5/30	18	1,8	1,2	15°	15° ATB	General Purpose	10	291.120.18H
125	20	-	20	2,4	1,4	15°	15° ATB	General Purpose	10	291.125.20H
130	20	-	20	2,4	1,4	15°	15° ATB	General Purpose	10	291.130.20H
140	20	-	20	2,4	1,4	15°	15° ATB	General Purpose	10	291.140.20H
150	20 (+16)	-	24	2,4	1,4	15°	15° ATB	General Purpose	10	291.150.24H
160	20	2/6/32	24	2,2	1,6	15°	15° ATB	General Purpose	10	291.160.24H ●
160	20	2/6/32	28	2,2	1,6	15°	10° ATB	General Purpose	10	285.160.28H ⚠️
160	30 (+16)	2/7/42	24	2,2	1,6	15°	15° ATB	General Purpose	10	291.160.24M
165	20	2/6/32	24	2,2	1,6	15°	15° ATB	General Purpose	10	291.165.24H
165	30	2/7/42	24	2,6	1,6	15°	15° ATB	General Purpose	10	291.165.24M
170	30	2/7/42	24	2,6	1,6	20°	10° ATB	General Purpose	10	291.170.24M
180	20	2/6/32	24	2,6	1,6	20°	10° ATB	General Purpose	10	291.180.24H
180	30	2/7/42	24	2,6	1,6	20°	10° ATB	General Purpose	10	291.180.24M
184	16	-	24	2,6	1,6	20°	10° ATB	General Purpose	10	291.184.24E
184	30	-	24	2,6	1,6	20°	10° ATB	General Purpose	10	291.184.24M
190	16	2/6/32	24	2,6	1,6	20°	10° ATB	General Purpose	10	291.190.24E
190	20	2/6/32	24	2,6	1,6	20°	10° ATB	General Purpose	10	291.190.24H
190	30	2/7/42	24	2,6	1,6	20°	10° ATB	General Purpose	10	291.190.24M
190	20 (FESTOOL® FF)	Key 5/7/2,5	32	2,6	1,8	10°	10° ATB	General Purpose	10	291.190.32FF ●
200	30	2/7/42	36	2,8	1,8	15°	15° ATB	General Purpose	10	291.200.36M
200	30	COMBI3	36	3,2	2,2	15°	10° ATB	General Purpose	10	285.036.08M ⚠️
210	25	-	36	2,8	1,8	15°	15° ATB	General Purpose	5	291.210.36L ■
210	30	2/7/42	36	2,8	1,8	15°	15° ATB	General Purpose	10	291.210.36M ●
216	30	2/7/42	48	2,8	1,8	-5° Neg.	15° ATB	Finish	10	291.216.48M ●
220	30	2/7/42	36	2,8	1,8	15°	15° ATB	General Purpose	10	291.220.36M
225	30	2/7/42	36	2,8	1,8	20°	15° ATB	General Purpose	10	291.225.36M ●
230	30	2/7/42	36	2,8	1,8	15°	15° ATB	General Purpose	10	291.230.36M ●
235	25	-	36	2,8	1,8	15°	15° ATB	General Purpose	5	291.235.36L ■
235	30	2/7/42	36	2,8	1,8	15°	15° ATB	General Purpose	10	291.235.36M
240	30	2/7/42	36	2,8	1,8	15°	15° ATB	General Purpose	10	291.240.36M
260	30	COMBI3	48	2,8	1,8	15°	10° ATB	General Purpose	5	285.048.11M ●
270	30	COMBI3	42	2,8	1,8	15°	10° ATB	General Purpose	5	291.270.42M

● Ideal for FESTOOL® & others

■ Until stock last

Ripping & Crosscut [General Purpose] - THIN KERF

271 ITK^{PLUS}



WOOD

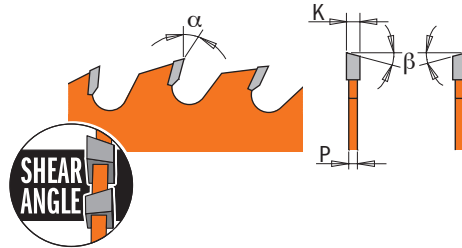
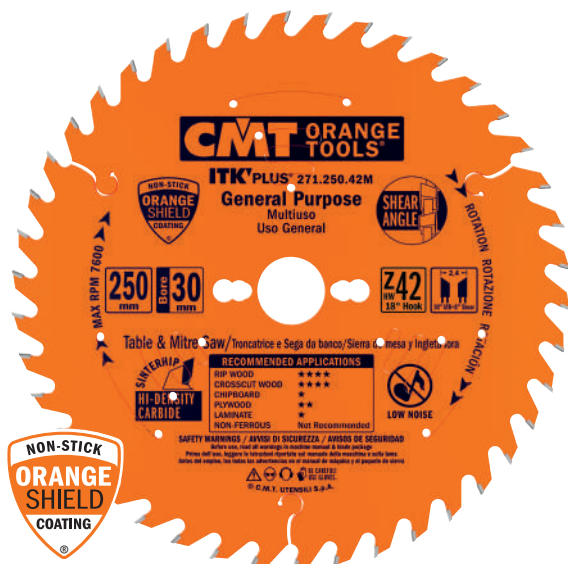

MACHINES

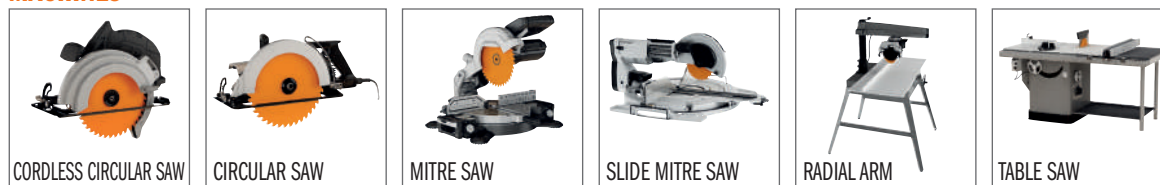

Blade diameter compatibility is contingent on machine type.

APPLICATIONS

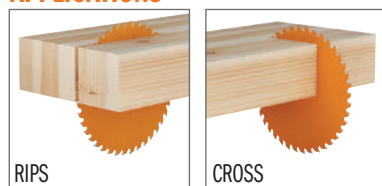

MATERIALS



D mm	B mm	PIN HOLE	Z	K mm	P mm	α	β		ORDER NO.
136	20 (+10)	-	18	1,5	1,0	20°	10° ATB + 8° Shear	10	271.136.18H
140	20	2/6/32,5	24	1,8	1,2	15°	15° ATB + 8° Shear	10	271.140.24H
150	20 (+16)	-	24	1,5	1,0	18°	10° ATB + 8° Shear	10	271.150.24H
160	20 (+16)	2/6/32	24	1,8	1,2	18°	10° ATB + 8° Shear	10	271.160.24H
165	20 (+15,87)	2/6/32	24	1,7	1,1	18°	10° ATB + 8° Shear	10	271.165.24H
165	30	2/7/42	24	1,7	1,1	18°	10° ATB + 8° Shear	10	271.165.24M
168	20	2/6/32	28	1,8	1,2	15°	15° ATB + 8° Shear	10	271.168.28H ●
184	20 (+16+15,87)	2/7/42	24	1,7	1,1	20°	10° ATB + 8° Shear	10	271.184.24H
184	30	2/7/42	24	1,7	1,1	20°	10° ATB + 8° Shear	10	271.184.24M
190	30 (+20+16)	2/7/42	24	1,7	1,1	20°	10° ATB + 8° Shear	10	271.190.24M
200	30	2/7/42	36	1,8	1,2	15°	10° ATB + 8° Shear	10	271.200.36M
210	30 (+25)	2/7/42	24	1,8	1,2	20°	10° ATB + 8° Shear	10	271.210.24M
210	30 (+25)	2/7/42	36	1,8	1,2	15°	10° ATB + 8° Shear	10	271.210.36M
216	30	2/7/42	36	1,8	1,2	-5° Neg.	10° ATB + 8° Shear	10	271.216.36M ■
235	25	-	36	1,7	1,2	20°	1 FLAT+2/15° ATB	10	271.235.36L
235	30 (+25)	2/7/42	36	2,4	1,6	18°	10° ATB + 8° Shear	10	271.235.36M
250	30	COMBI3	42	2,4	1,6	18°	10° ATB + 8° Shear	10	271.250.42M
300	30	COMBI3	48	2,6	1,8	18°	10° ATB + 8° Shear	5	271.300.48M
305	30	COMBI3	48	2,6	1,8	-5° Neg.	10° ATB	5	271.305.48M
315	30	COMBI3	54	2,6	1,8	-5° Neg.	10° ATB	5	271.315.54M

● Ideal for FESTOOL® & others

■ Until stock last

© Brand names mentioned in CMT products are the property of their respective owners (see back cover)



285 ORANGE CHROME®



WOOD

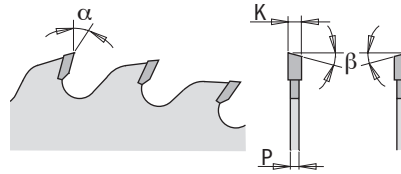

MACHINES

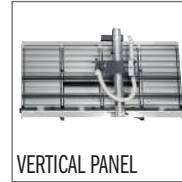

Blade diameter compatibility is contingent on machine type.



APPLICATIONS

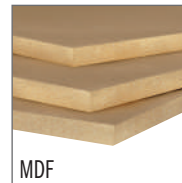

MATERIALS



For specific details regarding suggested materials, please check blade label.

D mm	B mm	PIN HOLE 	Z	K mm	P mm	α	β		ORDER NO.
216	30	2/7/42	48	2,3	1,6	-5° Neg.	15° ATB	1	285.816.48M ●
250	30	COMBI3	60	3,2	2,2	10°	15° ATB	1	285.660.10M
260	30	COMBI3	60	2,5	1,8	-5° Neg.	10° ATB	1	285.860.11M ●
300	30	COMBI3	72	3,2	2,2	10°	15° ATB	1	285.672.12M
350	30	COMBI3	84	3,5	2,5	10°	15° ATB	1	285.684.14M
400	30	COMBI3	96	3,5	2,5	10°	15° ATB	1	285.696.16M

● Ideal for **FESTOOL®** & others



285-294-295 XTREME

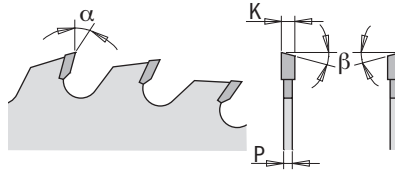

WOOD



MACHINES



MITRE SAW



RADIAL ARM



TABLE SAW

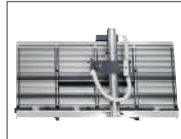

VERTICAL PANEL

Blade diameter compatibility is contingent on machine type.

APPLICATIONS



CROSS

MATERIALS



HARDWOOD



PLYWOOD



MELAMINE



LAMINATE



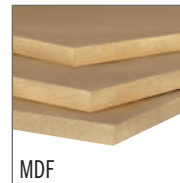

CHIPBOARD



MDF

For specific details regarding suggested materials, please check blade label.

D mm	B mm	PIN HOLE 	Z	K mm	P mm	α	β		ORDER NO.
250	30	COMBI3	60	3,2	2,2	10°	15° ATB	1	285.060.10M
250	35	-	60	3,2	2,2	10°	15° ATB	1	285.060.10R
254	30	COMBI3	60	2,4	1,8	-5° Neg.	15° ATB	1	294.060.10M
280*	30	COMBI3	64	2,8	1,8	10°	15° ATB	1	295.064.11M
300	30	COMBI3	60	3,2	2,2	15°	10° ATB	1	285.060.12M
300	30	COMBI3	72	3,2	2,2	10°	15° ATB	1	285.072.12M
300	35	-	72	3,2	2,2	10°	15° ATB	1	285.072.12R
305	30	COMBI3	72	3,2	2,2	10°	15° ATB	1	285.072.22M
305	30	COMBI3	72	3,2	2,2	-5° Neg.	15° ATB	1	294.072.22M
315	30	COMBI3	72	3,2	2,2	15°	10° ATB	1	285.072.13M
350	30	COMBI3	72	3,5	2,5	15°	10° ATB	1	285.072.14M
350	30	COMBI3	84	3,5	2,5	10°	15° ATB	1	285.084.14M
350	35	-	84	3,5	2,5	10°	15° ATB	1	285.084.14R
400	30	COMBI3	96	3,5	2,5	10°	15° ATB	1	285.096.16M
450	30	COMBI3	66	3,8	2,8	10°	15° ATB	1	285.066.18M
500	30	2/10/60	72	3,8	2,8	10°	15° ATB	1	285.072.20M
550	30	2/10/60	96	4,2	3,2	10°	15° ATB	1	285.096.22M

*Non-Silent Blades



285-292-294 INDUSTRIAL



WOOD

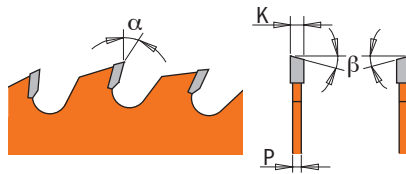

MACHINES



Blade diameter compatibility is contingent on machine type.

APPLICATIONS



MATERIALS



D mm	B mm	PIN HOLE	Z	K mm	P mm	α	β	APPLICATIONS		ORDER NO.
120	20	2/5,5/30	40	1,8	1,2	10°	15° ATB	Fine Finish	10	292.120.40H
125	20	-	36	2,4	1,4	15°	15° ATB	Fine Finish	10	292.125.36H
130	20	-	36	2,4	1,4	15°	15° ATB	Fine Finish	10	292.130.36H
140	20	-	36	2,4	1,4	15°	15° ATB	Fine Finish	10	292.140.36H
150	20	-	40	2,4	1,4	15°	15° ATB	Fine Finish	10	292.150.40H
150	30	2/7/42	48	3,2	2,2	5°	15° ATB	Fine Finish	10	285.048.06M
160	20	2/6/32	40	2,2	1,6	10°	15° ATB	Finish	10	292.160.40H ●
160	30	2/7/42	40	2,2	1,6	10°	15° ATB	Finish	10	292.160.40M
160	20	2/6/32	48	2,2	1,6	5°	15° ATB	Fine Finish	10	285.160.48H ●
165	20	2/6/32	40	2,2	1,6	10°	15° ATB	Finish	10	292.165.40H
165	30	2/7/42	40	2,6	1,6	10°	15° ATB	Finish	10	292.165.40M
170	30	2/7/42	40	2,6	1,6	15°	15° ATB	Finish	10	292.170.40M
180	20	2/6/32	40	2,6	1,6	15°	15° ATB	Finish	10	292.180.40H
180	30	2/7/42	40	2,6	1,6	15°	15° ATB	Finish	10	292.180.40M
180	30	2/7/42	56	3,2	2,2	5°	15° ATB	Fine Finish	10	285.056.07M
184	16	-	40	2,6	1,6	15°	15° ATB	Finish	10	292.184.40E
184	30	-	40	2,6	1,6	15°	15° ATB	Finish	10	292.184.40M
190	20 (+16)	2/6/32	40	2,6	1,6	15°	15° ATB	Finish	10	292.190.40H
190	30	2/7/42	40	2,6	1,6	15°	15° ATB	Finish	10	292.190.40M
190	20 (FESTOOL® FF)	Key 5/7/2,5	48	2,4	1,8	10°	15° ATB	Fine Finish	10	292.190.48FF ●
200	30	2/7/42	48	2,8	1,8	15°	15° ATB	Finish	10	292.200.48M
200	30	COMBI3	48	3,2	2,2	15°	15° ATB	Finish	10	285.048.08M
210	25	-	48	2,8	1,8	15°	15° ATB	Finish	5	292.210.48L ■
210	30	2/7/42	48	2,8	1,8	15°	15° ATB	Finish	10	292.210.48M ●
216	30	2/7/42	64	2,8	1,8	-5° Neg.	15° ATB	Fine Finish	10	292.216.64M ●
220	30	2/7/42	48	2,8	1,8	15°	15° ATB	Finish	10	292.220.48M
225	30	2/7/42	48	2,8	1,8	10°	15° ATB	Finish	10	292.225.48M ●
230	30	2/7/42	48	2,8	1,8	15°	15° ATB	Finish	10	292.230.48M ●
235	25	-	48	2,8	1,8	15°	15° ATB	Finish	5	292.235.48L ■
235	30	2/7/42	48	2,8	1,8	15°	15° ATB	Finish	10	292.235.48M
240	30	2/7/42	48	2,8	1,8	15°	15° ATB	Finish	10	292.240.48M
260	30	COMBI3	60	2,8	1,8	10°	15° ATB	Finish	5	285.060.11M ●
260	30	COMBI3	60	2,5	1,8	-5° Neg.	15° ATB	Finish	5	294.060.11M ●

● Ideal for FESTOOL® & others

■ Until stock last



272 ITK⁺ PLUS[®]



WOOD

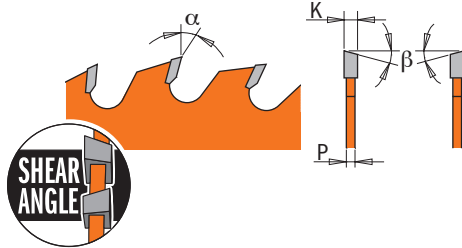

MACHINES



Blade diameter compatibility is contingent on machine type.

APPLICATIONS

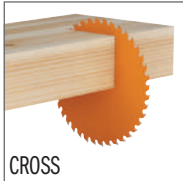

MATERIALS



D mm	B mm	PIN HOLE	Z	K mm	P mm	α	β		ORDER NO.
115	9,5	-	24	1,5	1,0	20°	10° ATB + 8° Shear	10	272.115.24
136	20 (+10)	-	36	1,5	1,0	18°	10° ATB + 8° Shear	10	272.136.36H
140	20	2/6/32,5	42	1,8	1,2	5°	15° ATB + 8° Shear	10	272.140.42H
150	20 (+16)	-	40	1,5	1,0	16°	10° ATB + 8° Shear	10	272.150.40H
160	20 (+16)	2/6/32	40	1,8	1,2	16°	10° ATB + 8° Shear	10	272.160.40H
165	20 (+15,87)	2/6/32	36	1,7	1,1	20°	10° ATB + 8° Shear	10	272.165.36H
new 168	20	2/6/32	42	1,8	1,2	10°	15° ATB + 8° Shear	10	272.168.42H ●
184	20 (+16+15,87)	2/7/42	40	1,7	1,1	18°	10° ATB + 8° Shear	10	272.184.40H
184	30	2/7/42	40	1,7	1,1	18°	10° ATB + 8° Shear	10	272.184.40M
190	30 (+20+16)	2/7/42	42	1,7	1,1	18°	10° ATB + 8° Shear	10	272.190.42M
200	30	2/7/42	48	1,8	1,2	15°	10° ATB + 8° Shear	10	272.200.48M
210	30 (+25)	2/7/42	48	1,8	1,2	15°	10° ATB + 8° Shear	10	272.210.48M
216	30	2/7/42	48	1,8	1,2	-5° Neg.	10° ATB + 8° Shear	10	272.216.48M
235	30 (+25)	2/7/42	48	2,4	1,6	18°	10° ATB + 8° Shear	10	272.235.48M
new 250*	30	COMBI3	50	2,4	1,6	15°	FLAT + 10° ATB + 8° Shear	10	272.250.50M
250	30	COMBI3	60	2,4	1,6	15°	10° ATB + 8° Shear	10	272.250.60M
300	30	COMBI3	72	2,6	1,8	15°	10° ATB + 8° Shear	5	272.300.72M
305	30	COMBI3	72	2,6	1,8	-5° Neg.	10° ATB	5	272.305.72M

*with Antikick-back

● Ideal for **FESTOOL**® & others



285 ORANGE CHROME®



WOOD

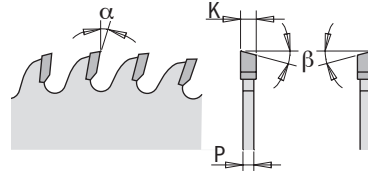

MACHINES

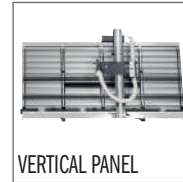

Blade diameter compatibility is contingent on machine type.

APPLICATIONS



MATERIALS

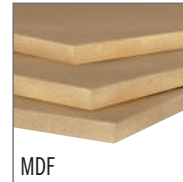

For specific details regarding suggested materials, please check blade label.

D mm	B mm	PIN HOLE	Z	K mm	P mm	α	β		ORDER NO.
160	20		48	2,2	1,6	5°	12° ATB	1	285.760.48H ●
160	20		48	1,8	1,2	5°	12° ATB	1	285.761.48H ●
168	20		48	1,8	1,2	5°	12° ATB	1	285.768.48H ●
190	20 (FESTOOL® FF)	-	48	2,4	1,8	8°	15° ATB	1	285.790.48FF ●
216	30		60	2,3	1,6	-5° Neg.	15° ATB	1	285.816.60M ●
250	30	COMBI3	80	3,2	2,2	5°	15° ATB	1	285.680.10M
300	30	COMBI3	96	3,2	2,2	5°	15° ATB	1	285.696.12M
350	30	COMBI3	108	3,5	2,5	5°	15° ATB	1	285.708.14M

● Ideal for FESTOOL® & others

RESULTS OF OUR TEST

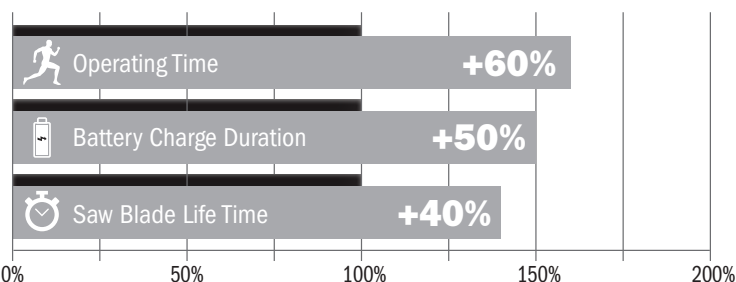

FULL KERF BLADE (K=2,2mm)

THIN KERF BLADE (K=1,8mm)

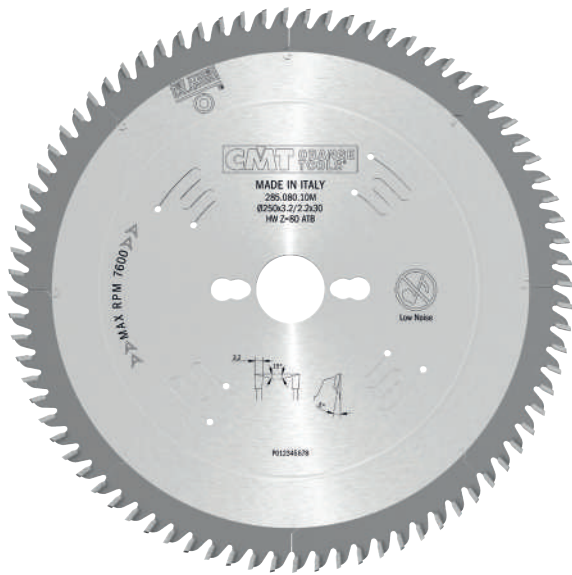

285 XTREME

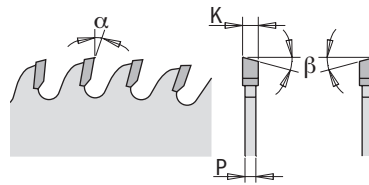

WOOD



MACHINES

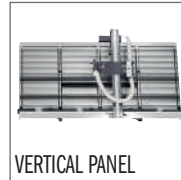

Blade diameter compatibility is contingent on machine type.

APPLICATIONS



MATERIALS

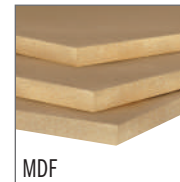

D mm	B mm	PIN HOLE ⊕⊕	Z	K mm	P mm	α	β		ORDER NO.
250	30	COMBI3	80	3,2	2,2	5°	15° ATB	1	285.080.10M
250	35	-	80	3,2	2,2	5°	15° ATB	1	285.080.10R
300	30	COMBI3	96	3,2	2,2	5°	15° ATB	1	285.096.12M
300	35	-	96	3,2	2,2	5°	15° ATB	1	285.096.12R
350	30	COMBI3	108	3,5	2,5	5°	15° ATB	1	285.108.14M
350	35	-	108	3,5	2,5	5°	15° ATB	1	285.108.14R
400	30	COMBI3	120	3,5	2,5	10°	15° ATB	1	285.120.16M



287 INDUSTRIAL

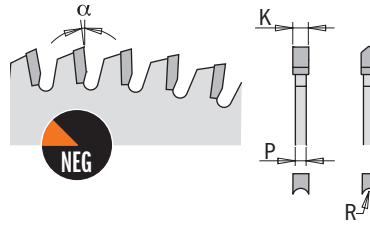

WOOD

MACHINES



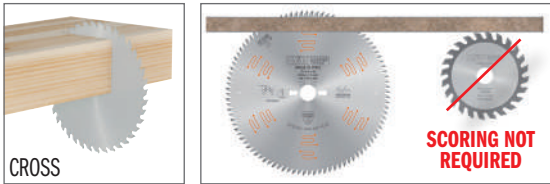

Blade diameter compatibility is contingent on machine type.

APPLICATIONS



MATERIALS



D mm	B mm	PIN HOLE 	Z	K mm	P mm	α	β		ORDER NO.
220	30	2/7/42	42	3,2	2,2	-6° Neg.	HDF	1	287.043.09M
250	30	COMBI3	48	3,2	2,2	-6° Neg.	HDF	1	287.049.10M
303	30	COMBI3	60	3,2	2,2	-6° Neg.	HDF	1	287.061.12M



287 INDUSTRIAL

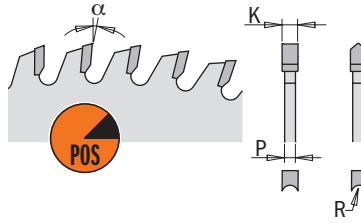

WOOD

MACHINES



CIRCULAR SAW



SLIDE MITRE SAW



MITRE SAW



TABLE SAW

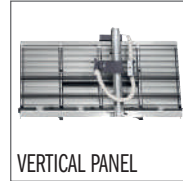

VERTICAL PANEL

Blade diameter compatibility is contingent on machine type.

APPLICATIONS



CROSS



SCORING NOT REQUIRED

MATERIALS



HARDWOOD



SOFTWOOD



PLYWOOD



VEENERED PLYWOOD

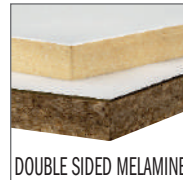

DOUBLE SIDED MELAMINE

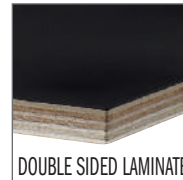

DOUBLE SIDED LAMINATE

D mm	B mm	PIN HOLE 	Z	K mm	P mm	α	β		ORDER NO.
160	20	2/6/32	34	2,6	1,8	10°	HDF	1	287.034.06H
220	30	2/7/42	42	3,2	2,2	10°	HDF	1	287.042.09M
250	30	COMBI3	48	3,2	2,2	10°	HDF	1	287.048.10M
303	30	COMBI3	60	3,2	2,2	10°	HDF	1	287.060.12M



285-292-294 INDUSTRIAL



WOOD

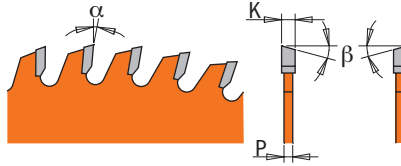

MACHINES







Blade diameter compatibility is contingent on machine type.

APPLICATIONS



MATERIALS



D mm	B mm	PIN HOLE 	Z	K mm	P mm	α	β		ORDER NO.
160	20	2/6/32	56	2,2	1,6	15°	15° ATB	10	292.160.56H ●
165	20	2/6/32	56	2,2	1,6	15°	15° ATB	10	292.165.56H ●
190	30	2/7/42	64	2,6	1,6	15°	15° ATB	10	292.190.64M ●
200	30	COMBI3	64	3,2	2,2	5°	15° ATB	10	 285.064.08M ●
210	30	2/7/42	64	2,8	1,8	15°	15° ATB	10	292.210.64M ●
216	30	2/7/42	80	2,8	1,8	-5° Neg.	15° ATB	10	292.216.80M ●
230	30	2/7/42 + 2/10/60	64	2,8	1,8	15°	15° ATB	10	292.230.64M ●
260	30	COMBI3	80	2,5	1,8	-5° Neg.	15° ATB	5	 294.080.11M ●

● Ideal for **FESTOOL**® & others



273 ITK⁺ PLUS®



WOOD

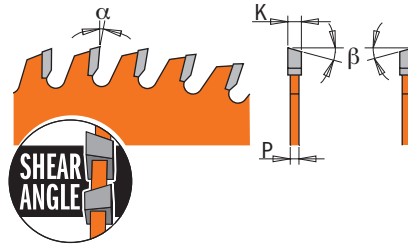

MACHINES

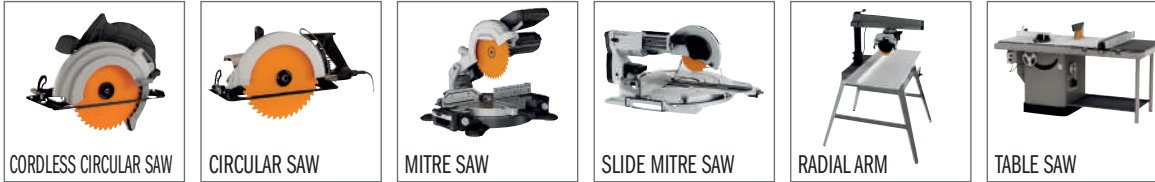

Blade diameter compatibility is contingent on machine type.

APPLICATIONS

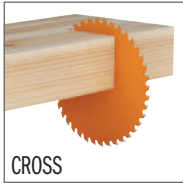

MATERIALS



For specific details regarding suggested materials, please check blade label.

D mm	B mm	PIN HOLE 	Z	K mm	P mm	α	β		ORDER NO.
50	10	-	20	1,1	0,8	15°	10° ATB	10	273.050.20D ●
80	10	-	36	1,6	1,0	15°	10° ATB	10	273.080.36D ●
160	20 (+16)	2/6/32	56	1,8	1,2	12°	10° ATB + 8° Shear	10	273.160.56H
165	20 (+15,87)	2/6/32	56	1,6	1,0	12°	15° ATB + 8° Shear	10	273.165.56H
190	30 (+20+16)	2/7/42	64	1,7	1,1	15°	10° ATB + 8° Shear	10	273.190.64M
216	30	2/7/42	64	1,8	1,2	-5° Neg.	10° ATB + 8° Shear	10	273.216.64M
250	30	COMBI3	80	2,4	1,6	12°	10° ATB + 8° Shear	10	273.250.80M
300	30	COMBI3	96	2,6	1,8	12°	10° ATB + 8° Shear	5	273.300.96M

● Ideal for PROXXON® (Materials: Wood, Plastics, Non-ferrous)

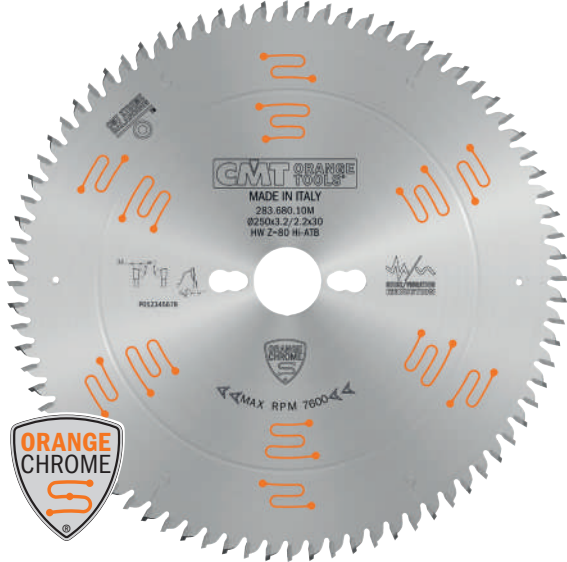

283.6 ORANGE CHROME®



WOOD

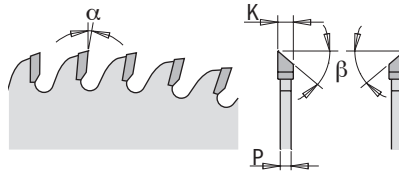

MACHINES

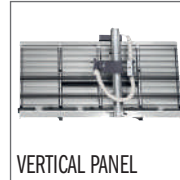



Blade diameter compatibility is contingent on machine type.

APPLICATIONS

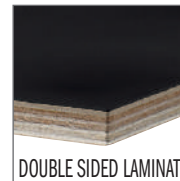
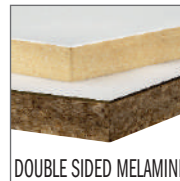

MATERIALS



D mm	B mm	PIN HOLE 	Z	K mm	P mm	α	β		ORDER NO.
250	30	COMBI3	80	3,2	2,2	-2° Neg.	38° Hi-ATB	1	283.680.10M
300	30	COMBI3	96	3,2	2,2	2°	38° Hi-ATB	1	283.696.12M



283 XTREME

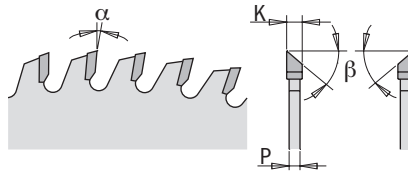

WOOD



MACHINES



Blade diameter compatibility is contingent on machine type.

APPLICATIONS



MATERIALS



D mm	B mm	PIN HOLE 	Z	K mm	P mm	α	β		ORDER NO.
220*	30	2/7/42	64	3,2	2,2	-5° Neg.	40° Hi-ATB	1	283.064.09M
250	30	COMBI3	80	3,2	2,2	-2° Neg.	40° Hi-ATB	1	283.080.10M
300	30	COMBI3	96	3,2	2,2	2°	40° Hi-ATB	1	283.096.12M
350	30	COMBI3	108	3,5	2,5	5°	40° Hi-ATB	1	283.108.14M

*Non-Silent Blades

Ultra Fine Finishing - FRAMES



285.5 ORANGE CHROME®



WOOD

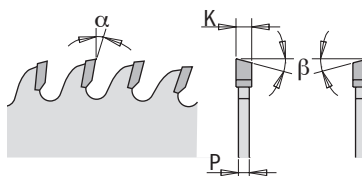

MACHINES





Blade diameter compatibility is contingent on machine type.

APPLICATIONS

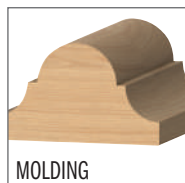
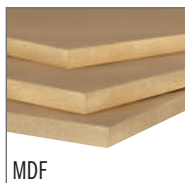

MATERIALS



D mm	B mm	PIN HOLE 	Z	K mm	P mm	α	β		ORDER NO.
250	30	COMBI3	80	3,0	2,5	10°	20° ATB	1	285.580.10M
300	30	COMBI3	96	3,0	2,5	10°	20° ATB	1	285.596.12M

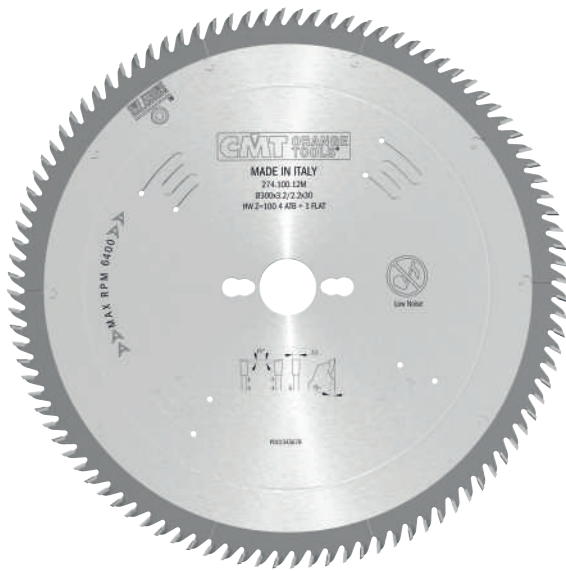

274 XTREME



WOOD

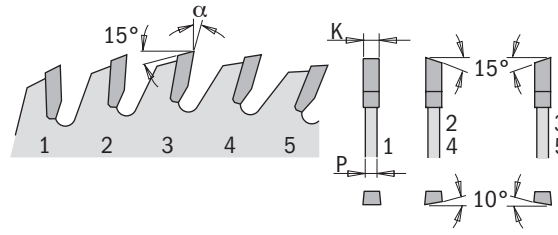

MACHINES

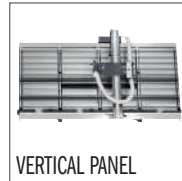

Blade diameter compatibility is contingent on machine type.

APPLICATIONS



MATERIALS

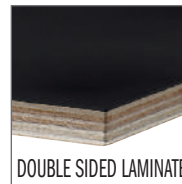
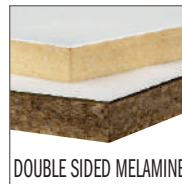

D mm	B mm	PIN HOLE ⊕⊕	Z	K mm	P mm	α	β		ORDER NO.
250	30	COMBI3	80	3,2	2,2	15°	1° FLAT + 4° ATB	1	274.080.10M
300	30	COMBI3	100	3,2	2,2	15°	1° FLAT + 4° ATB	1	274.100.12M

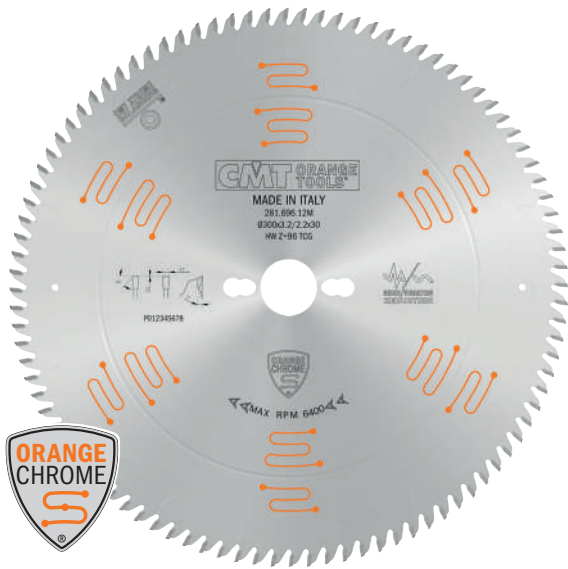

281 ORANGE CHROME®



WOOD

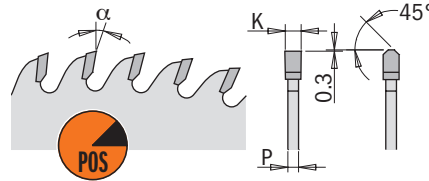

MACHINES

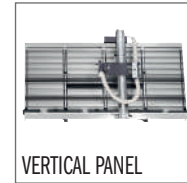

Blade diameter compatibility is contingent on machine type.

APPLICATIONS



MATERIALS

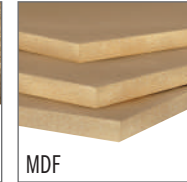
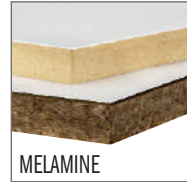

For specific details regarding suggested materials, please check blade label.

D mm	B mm	PIN HOLE ⊕⊕	Z	K mm	P mm	α	β		ORDER NO.
160	20	2/6/32	48	2,2	1,6	4°	TCG	1	281.760.48H ●
190	20 (FESTOOL® FF)	-	54	2,6	1,8	4°	TCG	1	281.790.54FF ●
250	30	COMBI3	80	3,2	2,2	5°	TCG	1	281.680.10M
300	30	COMBI3	72	3,2	2,2	10°	TCG	1	281.672.12M
300	30	COMBI3	96	3,2	2,2	5°	TCG	1	281.696.12M
350	30	COMBI3	84	3,5	2,5	10°	TCG	1	281.684.14M
350	30	COMBI3	108	3,5	2,5	5°	TCG	1	281.708.14M

● Ideal for FESTOOL® & others

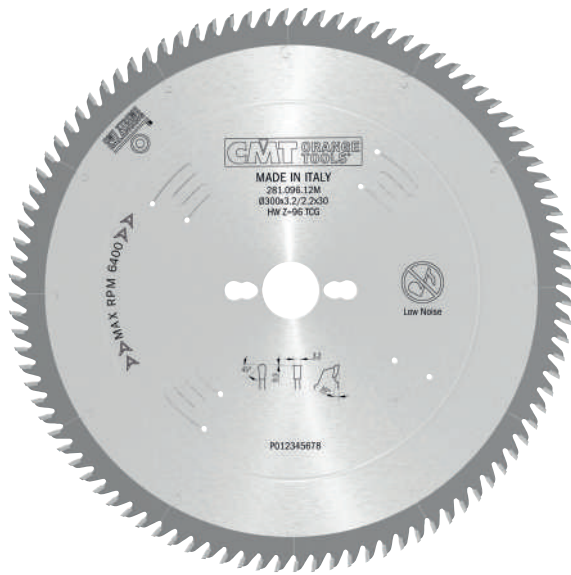

281 XTREME

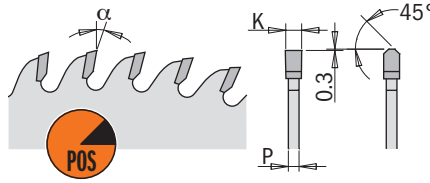

WOOD

MACHINES



Blade diameter compatibility is contingent on machine type.

APPLICATIONS



MATERIALS

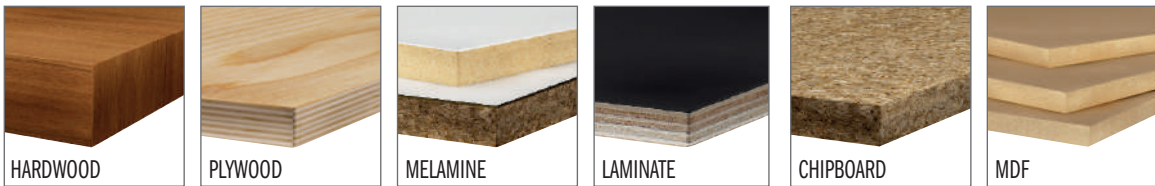

D mm	B mm	PIN HOLE ⊕⊕⊕	Z	K mm	P mm	α	β		ORDER NO.
250	30	COMBI3	60	3,2	2,2	10°	TCG	1	281.060.10M
250	30	COMBI3	80	3,2	2,2	10°	TCG	1	281.080.10M
300	30	COMBI3	72	3,2	2,2	10°	TCG	1	281.072.12M
300	30	COMBI3	96	3,2	2,2	10°	TCG	1	281.096.12M
350	30	COMBI3	84	3,5	2,5	10°	TCG	1	281.084.14M
350	30	COMBI3	108	3,5	2,5	10°	TCG	1	281.108.14M



295 XTREME



WOOD

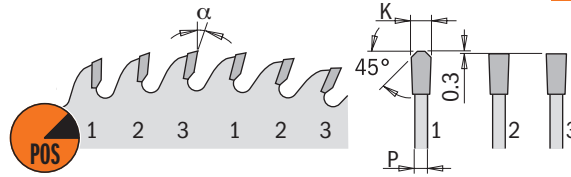

MACHINES

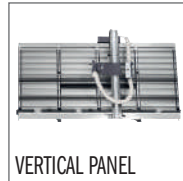

Blade diameter compatibility is contingent on machine type.

APPLICATIONS



MATERIALS

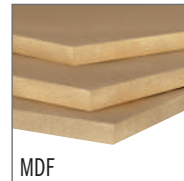

D mm	B mm	PIN HOLE	Z	K mm	P mm	α	β		ORDER NO.
250	30	COMBI3	78	3,2	2,2	10°	FFT	1	295.078.10M
300	30	COMBI3	96	3,2	2,2	10°	FFT	1	295.096.12M
350	30	COMBI3	108	3,5	2,5	10°	FFT	1	295.108.14M



281 XTREME



WOOD

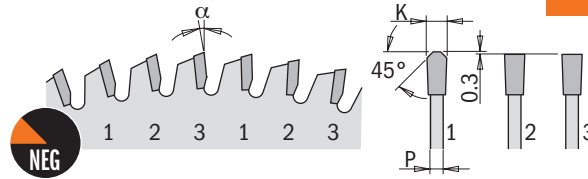

MACHINES



Blade diameter compatibility is contingent on machine type.

APPLICATIONS

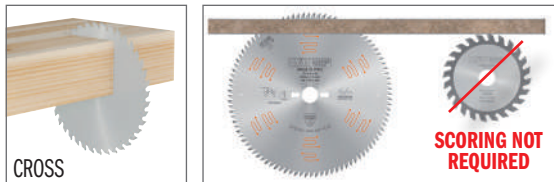

MATERIALS

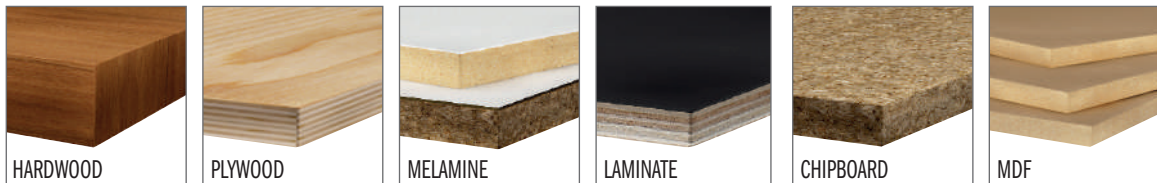

D mm	B mm	PIN HOLE	Z	K mm	P mm	α	β		ORDER NO.
220	30	COMBI3	63	3,2	2,2	-3° Neg.	FFT	1	281.063.09M
250	30	COMBI3	60	3,2	2,2	-3° Neg.	FFT	1	281.061.10M
300	30	COMBI3	72	3,2	2,2	-3° Neg.	FFT	1	281.073.12M



281 ORANGE CHROME®

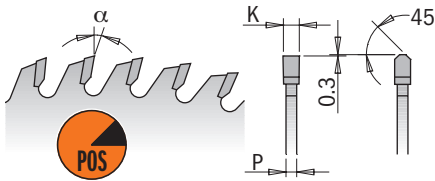
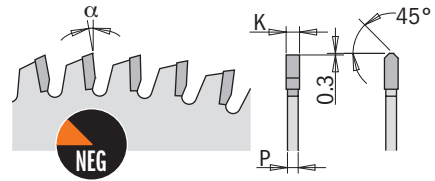

WOOD

MACHINES

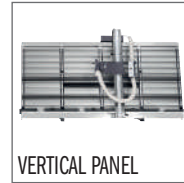

Blade diameter compatibility is contingent on machine type.

APPLICATIONS



MATERIALS

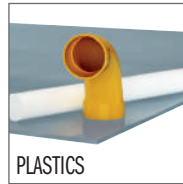
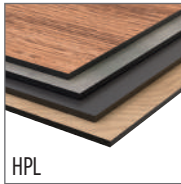
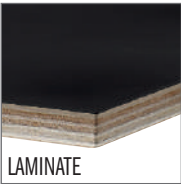

D mm	B mm	PIN HOLE	Z	K mm	P mm	α	β		ORDER NO.
160	20	2/6/32	52	1,8	1,2	-5° Neg.	TCG	1	281.761.52H ●
165	20	2/6/32	52	1,8	1,2	-5° Neg.	TCG	1	281.766.52H ●
168	20	2/6/32	52	1,8	1,2	-5° Neg.	TCG	1	281.768.52H ●
190	30	2/7/42	54	2,6	1,8	4°	TCG	1	281.790.54M ●
210	30	2/7/42	60	2,6	1,6	-3° Neg.	TCG	1	281.810.60M ●
216	30	2/7/42	64	2,6	1,6	-3° Neg.	TCG	1	281.816.64M ●
250	30	COMBI3	80	3,2	2,2	-3° Neg.	TCG	1	281.681.10M
300	30	COMBI3	96	3,2	2,2	-3° Neg.	TCG	1	281.697.12M

● Ideal for **FESTOOL®** & others

281 INDUSTRIAL



WOOD



MACHINES



APPLICATIONS

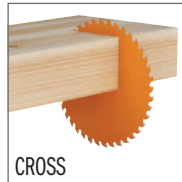

Blade diameter compatibility is contingent on machine type.

MATERIALS

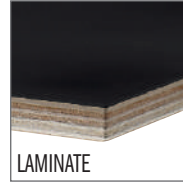

For specific details regarding suggested materials, please check blade label.

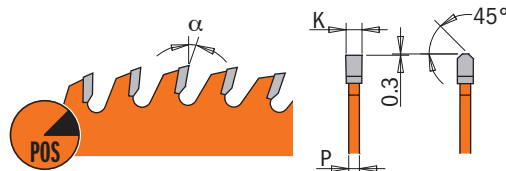

POSITIVE

D mm	B mm	PIN HOLE	Z	K mm	P mm	α	β	APPLICATIONS		ORDER NO.
160	20 (VIRUTEX®)	4/7/32 45°	40	2,2	1,6	10°	TCG	Finish	10	281.160.40H
160	20	2/6/32	48	2,2	1,6	5°	TCG	Fine Finish	10	281.160.48H ●
200	30	2/7/42	64	3,2	2,2	10°	TCG	Fine Finish	10	281.064.08M
220	30	2/7/42	64	3,2	2,2	10°	TCG	Fine Finish	10	281.064.09M
225	30	2/7/42	64	2,6	1,8	4°	TCG	Fine Finish	10	281.225.64M ●

● Ideal for **FESTOOL®** & others

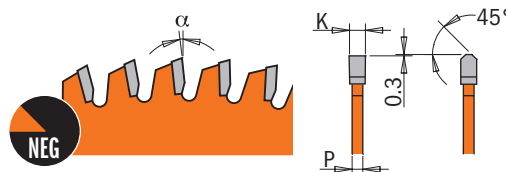

NEGATIVE

D mm	B mm	PIN HOLE	Z	K mm	P mm	α	β	APPLICATIONS		ORDER NO.
160	20	2/6/32	56	2,2	1,6	-3° Neg.	TCG	Ultra Finish	10	281.161.56H ●
165	20	2/6/32	56	2,2	1,6	-3° Neg.	TCG	Ultra Finish	10	281.166.56H
260	30	COMBI3	64	2,5	1,8	-3° Neg.	TCG	Finish	5	281.065.11M ●

● Ideal for **FESTOOL®** & others



WOOD

281-282 INDUSTRIAL

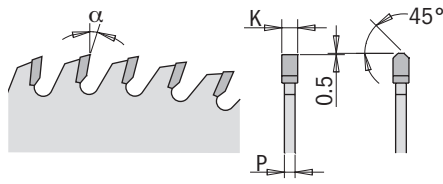

MACHINES

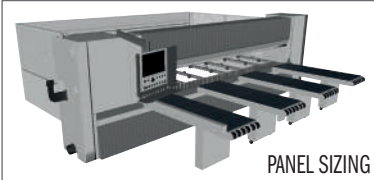

MATERIALS

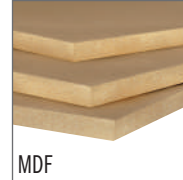

D mm	B mm	PIN HOLE 	Z	K mm	P mm	α	β	LOW NOISE 		ORDER NO.
300	30	COMBI3	60	4,4	3,2	16°	TCG		1	282.060.12M ■
300	75	-	60	4,4	3,2	16°	TCG		1	282.060.12X
300	80	COMBI5	60	4,4	3,2	16°	TCG		1	282.060.12W ■
320	65	2/9/100 + 2/9/110	60	4,4	3,2	16°	TCG		1	Y282.060.13J ■
320	65	2/9/100 + 2/9/110	72	4,4	3,2	16°	TCG		1	282.072.13J ■
350	30	COMBI3	54	4,4	3,2	16°	TCG		1	282.054.14M
350	30	COMBI3	72	4,4	3,2	16°	TCG		1	282.072.14M ■
350	30	COMBI3	108	3,5	2,5	10°	TCG		1	281.108.14M
350	50	3/12,5/80	72	4,4	3,2	16°	TCG		1	282.072.14T
350	60	2/14/100	72	4,4	3,2	16°	TCG		1	Y282.072.14U ■
350	75	4/15/105 + 3/7/100	54	4,4	3,2	16°	TCG		1	282.054.14X
350	75	4/15/105 + 3/7/100	72	4,4	3,2	16°	TCG		1	282.072.14X ■
350	80	COMBI5	54	4,4	3,2	16°	TCG		1	282.054.14W
350	80	COMBI5	72	4,4	3,2	16°	TCG		1	282.072.14W ■
355	30	COMBI3	72	4,4	3,2	16°	TCG		1	S282.03556
355	65	2/9/100 + 2/9/110	72	4,4	3,2	16°	TCG		1	282.072.14J2 ■
355	80	4/9/100 + 2/9/110 + 2/14/110	72	4,4	3,2	10°	TCG		1	282.072.14W2
380	60	2/14/100	72	4,4	3,2	15°	TCG		1	282.072.15U2 ■
380	60	COMBI7	72	4,8	3,5	16°	TCG		1	282.072.15U ■
380	80	COMBI5	72	4,4	3,2	16°	TCG		1	282.072.15W ■
400	30	2/10/60	60	4,4	3,2	16°	TCG		1	282.060.16M
400	30	2/10/60	72	4,4	3,2	16°	TCG		1	282.072.16M ■
400	60	COMBI7	72	4,4	3,2	16°	TCG		1	282.072.16U
400	75	4/15/105	60	4,4	3,2	16°	TCG		1	282.060.16X
400	75	4/15/105	72	4,4	3,2	16°	TCG		1	282.072.16X ■
400	80	COMBI5	60	4,4	3,2	16°	TCG		1	282.060.16W
400	80	COMBI5	72	4,4	3,2	16°	TCG		1	282.072.16W ■
420	80	4/9/100 + 2/9/110 + 2/14/110	72	4,4	3,2	15°	TCG		1	282.072.17W
430	65	2/9/100 + 2/9/110	72	4,4	3,2	16°	TCG		1	Y282.072.17J
430	75	4/15/105	72	4,4	3,2	16°	TCG		1	282.072.17X
430	80	COMBI5	72	4,4	3,2	16°	TCG		1	282.072.17W2
450	30	COMBI3 + 2/14/95	72	4,4	3,2	16°	TCG		1	Y282.072.18M2
450	60	COMBI7	72	4,8	3,5	16°	TCG		1	282.072.18U ■
450	80	COMBI5	72	4,8	3,5	16°	TCG		1	282.072.18W2
500	60	COMBI7	72	4,8	3,5	16°	TCG		1	282.072.20U

■ Until stock last

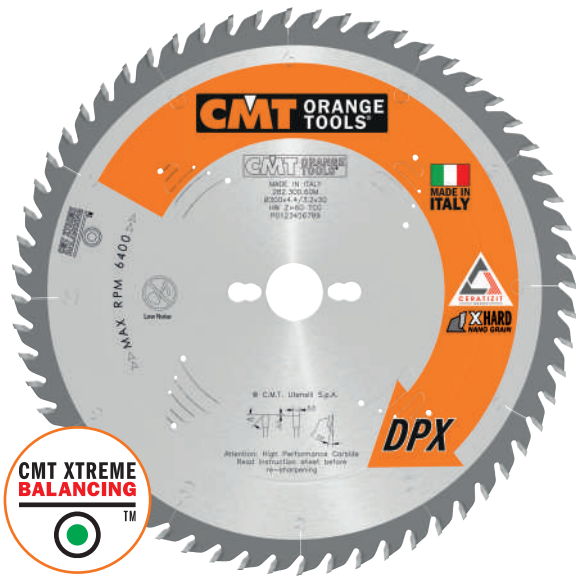

282 XTREME

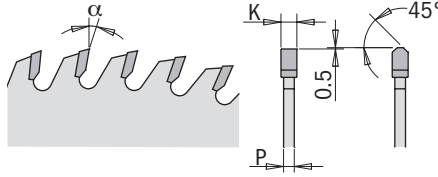

WOOD



NANO GRAIN CARBIDE

Cutting teeth are made from an exclusive high-pressure sintering and the use of nano grain carbide powders make the material free of porosity, extremely hard and compact, with excellent tenacity that ensures greater resistance to wear as compared to others and exceptional durability.

% METERS CUT ON CHIPBOARD PANELS

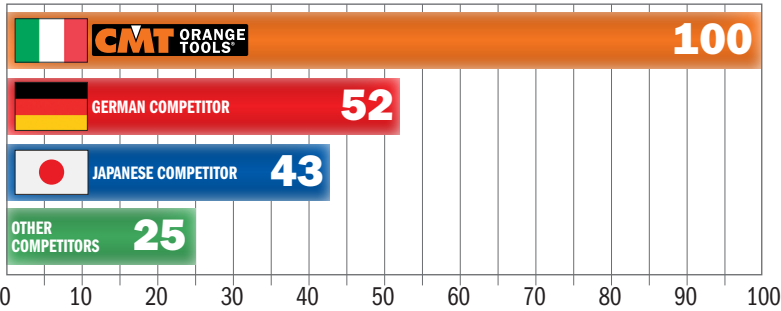

UP TO 4X THAN COMPETITORS



HOW TO RE-SHARPEN A CMT DPX BLADE



MACHINES

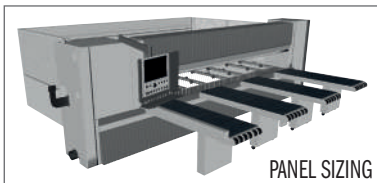

MATERIALS

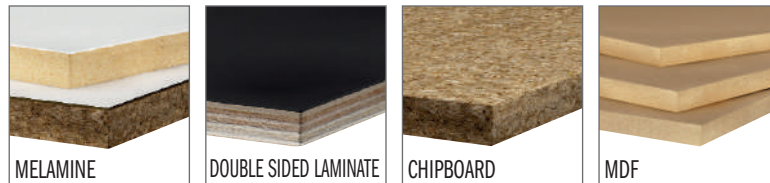

D mm	B mm	PIN HOLE	Z	K mm	P mm	α	β		ORDER NO.
300	30	COMBI3	60	4,4	3,2	15°	TCG	1	282.300.60M
300	80	COMBI5	60	4,4	3,2	16°	TCG	1	282.300.60W
320	65	2/9/100 + 2/14/110	60	4,4	3,2	15°	TCG	1	282.320.60J
320	65	2/9/100 + 2/14/110	72	4,4	3,2	15°	TCG	1	282.320.72J
350	30	COMBI3	72	4,4	3,2	15°	TCG	1	282.350.72M
350	60	2/9/100 + 2/14/110	72	4,4	3,2	15°	TCG	1	282.350.72U
350	75	3/7/100 + 4/15/105	72	4,4	3,2	15°	TCG	1	282.350.72X
350	80	COMBI5	72	4,4	3,2	16°	TCG	1	282.350.72W
355	65	2/9/100 + 2/9/110	72	4,4	3,2	16°	TCG	1	282.355.72J
380	60	2/14/100	72	4,4	3,2	15°	TCG	1	282.380.72U2
380	60	COMBI7	72	4,8	3,5	15°	TCG	1	282.380.72U
380	80	COMBI5	72	4,4	3,2	16°	TCG	1	282.380.72W
400	30	COMBI3	72	4,4	3,2	15°	TCG	1	282.400.72M
400	75	4/15/105	72	4,4	3,2	16°	TCG	1	282.400.72X
400	80	COMBI5	72	4,4	3,2	15°	TCG	1	282.400.72W
450	60	COMBI7	72	4,8	3,5	15°	TCG	1	282.450.72U



WOOD



289 X-TREME

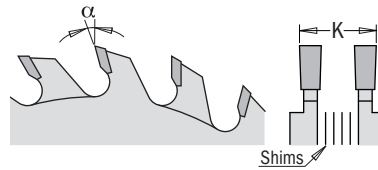

TIPS: suggested for machines without vertical regulation of scoring blade.

MACHINES



APPLICATIONS

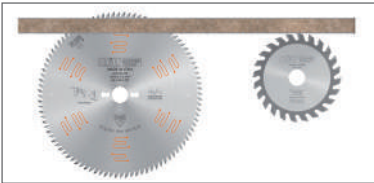

MATERIALS

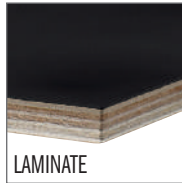

D mm	B mm	PIN HOLE	Z	K mm	α	β		ORDER NO.
70	20	-	8+8	2,8-3,6	12°	FLAT	10	289.070.16H
80	20	-	10+10	2,8-3,6	12°	FLAT	10	289.080.20H
100	20	-	10+10	2,8-3,6	12°	FLAT	10	289.100.20H
100	22	-	10+10	2,8-3,6	12°	FLAT	10	289.100.20K
120	20	-	12+12	2,8-3,6	12°	FLAT	10	289.120.24H
120	22	-	12+12	2,8-3,6	12°	FLAT	10	289.120.24K
120	50	-	12+12	2,8-3,6	12°	FLAT	10	289.120.24T ●
125	20	-	12+12	2,8-3,6	12°	FLAT	10	289.125.24H
125	22	-	12+12	2,8-3,6	12°	FLAT	10	289.125.24K

Spare parts

	PVC SHIMS
	299.000.05H
	299.000.05H
	299.000.02K
	299.000.02K
	299.000.02K
	299.000.02K
	299.000.02K
	299.000.02K

● Ideal for **ALTENDORF® Rapido System**



288 XTREME



WOOD

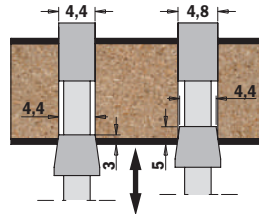
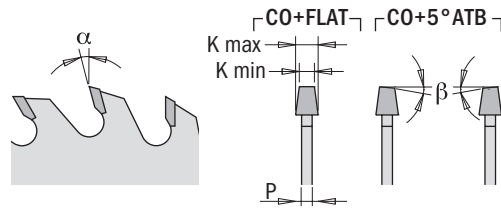

TIPS: suggested for machines with vertical regulation of scoring blade.

Suggested for use with thick kerf or panel sizing blade.

MACHINES



SQUARING

APPLICATIONS



MATERIALS

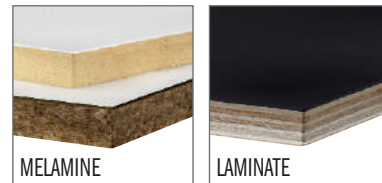

D mm	B mm	PIN HOLE	Z	K mm	P mm	α	β		ORDER NO.
80	20	-	12	3,1-3,6	2,2	10°	CO+FLAT	10	S288.080.12H
100	20	-	20	3,1-4,0	2,5	5°	CO+5° ATB	10	288.100.20H
100	22	-	20	3,1-4,0	2,5	5°	CO+5° ATB	10	288.100.20K
120	20	-	24	3,1-4,0	2,5	5°	CO+5° ATB	10	288.120.24H
120	20	-	24	3,4-4,2	2,5	5°	CO+5° ATB	10	288.120.24H1
120	22	-	24	3,1-4,0	2,5	5°	CO+5° ATB	10	288.120.24K
125	20	-	24	3,1-4,0	2,5	5°	CO+5° ATB	10	288.125.24H
125	20	-	24	3,4-4,2	2,5	5°	CO+5° ATB	10	288.125.24H1
125	20	-	24	4,3-5,5	3,2	10°	CO+FLAT	10	288.125.24H2
125	22	-	24	3,1-4,0	2,5	5°	CO+5° ATB	10	288.125.24K
125	45	-	24	4,3-5,5	3,2	10°	CO+FLAT	10	288.125.24Q
150	45	3/11/70	36	4,3-5,5	3,2	10°	CO+FLAT	5	288.150.36Q
160	45	3/11/70	36	4,3-5,5	3,2	10°	CO+FLAT	5	288.160.36Q
160	55	3/7/66 + 3/6/84	36	4,3-5,5	3,2	10°	CO+FLAT	5	288.160.360
180	20	-	36	4,3-5,5	3,2	10°	CO+FLAT	5	Y288.180.36H ■
180	30	COMBI3	36	4,5-5,5	3,2	10°	CO+FLAT	5	288.180.36M
180	45	-	36	4,3-5,5	3,2	8°	CO+5° ATB	5	288.180.36Q2
180	45	-	36	4,7-6,0	3,5	10°	CO+FLAT	5	288.180.36Q
180	55	-	36	5,0-6,2	3,5	10°	CO+FLAT	5	288.180.360 ■
180	50	3/12,5/80	44	4,3-5,5	3,2	10°	CO+FLAT	5	288.180.44T
200	20	-	36	4,4-5,3	3,2	10°	CO+FLAT	5	288.200.36H
200	45	-	36	4,7-6,0	3,5	10°	CO+FLAT	5	288.200.36Q
200	45	-	36	4,3-5,5	3,2	10°	CO+FLAT	5	Y288.200.36Q2
200	65	2/9/100 + 2/9/110	36	4,4-5,3	3,2	10°	CO+FLAT	5	288.200.36J
215	50	3/15/80	42	4,3-5,5	3,2	8°	CO+FLAT	5	288.215.42T
300	50	3/15/80	48	4,3-5,5	3,2	10°	CO+FLAT	5	288.300.48T
300	65	2/9/100 + 2/9/110	72	4,3-5,5	3,2	10°	CO+FLAT	5	288.300.72J

■ Until stock last

DP - Laminated & Chipboard - LONG LIFE



237 XTREME



WOOD

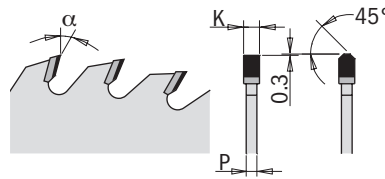

50X
LONGER LIFE
THAN CARBIDE

MACHINES



MITRE SAW



SQUARING



TABLE SAW



VERTICAL PANEL

Blade diameter compatibility is contingent on machine type.

High-quality nickel-plated saw blades with anti-friction and anti-corrosion properties.

APPLICATIONS



CROSS

MATERIALS



HARDWOOD



PLYWOOD



MELAMINE

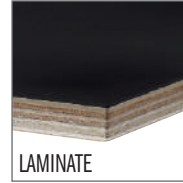

LAMINATE

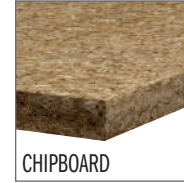

CHIPBOARD

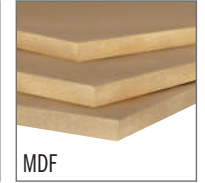

MDF

D mm	B mm	PIN HOLE	Z	K mm	P mm	α	β		ORDER NO.
250	30	COMBI3	48	3,2	2,2	10°	TCG	1	237.048.10M
300	30	COMBI3	60	3,2	2,2	10°	TCG	1	237.060.12M
300	30	COMBI3	96	3,2	2,2	15°	TCG	1	237.096.12M
350	30	COMBI3	72	3,5	2,4	15°	TCG	1	237.072.14M

DP - Conical Scoring - LONG LIFE



238 XTREME



WOOD

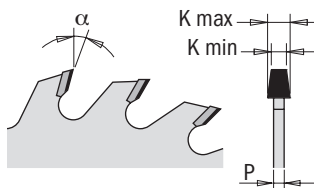

50X
LONGER LIFE
THAN CARBIDE

MACHINES



SQUARING

APPLICATIONS

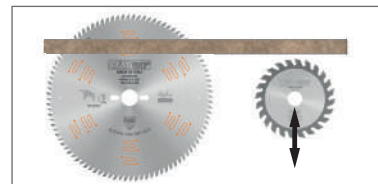

MATERIALS



MELAMINE



LAMINATE

D mm	B mm	PIN HOLE	Z	K mm	P mm	α	β		ORDER NO.
120	20	-	20	3,1-3,7	2,2	5°	CONICAL	1	238.120.20H
125	20	-	20	3,1-3,7	2,2	5°	CONICAL	1	238.125.20H



LEUCO
Patent Pending

235 X-TREME ALL-ROUND

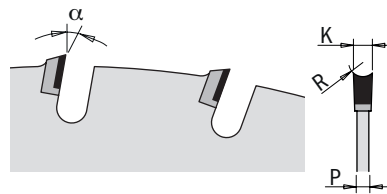

50X
LONGER LIFE
THAN CARBIDE



MACHINES

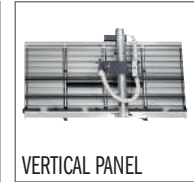

Blade diameter compatibility is contingent on machine type.

MATERIALS

NO LIMITS: CUT ALL WITH ONE BLADE!

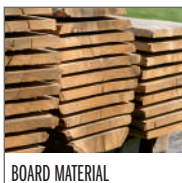
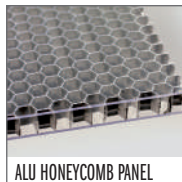

X-TREME-NOISELESS

Thanks to the new minimization of gullets design this blade succeeded in reducing the noise of idling by up to 15 dB(A) compared to conventional carbide saw blades. With a noise level of just around 70dB(A) when idling, the wearing of hearing protection is outdated.

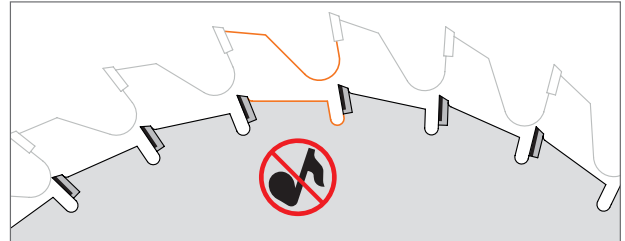

X-TREME-ALL-ROUND

New industry standard with universal application in countless materials and suitable for all chop saws and portable machines, table and vertical panel sizing saws, CNCs and through-feed installations

X-TREME-QUALITY

The special hollow back tooth configuration (HR) guarantees an excellent cutting quality.

X-TREME-FAST

The teeth are surprisingly thin! The cutting width is a mere 2,5 mm and they generate noticeably lower cutting pressure and therefore also require less power during usage. Resharpenable max 2 times.

X-TREME-LIFETIME

The lifetime is 20X longer than carbide blades thanks to the diamond tips.

RECOMMENDED USE

We recommend the use of a splitting wedge between **2,0** and **2,4**mm in thickness.

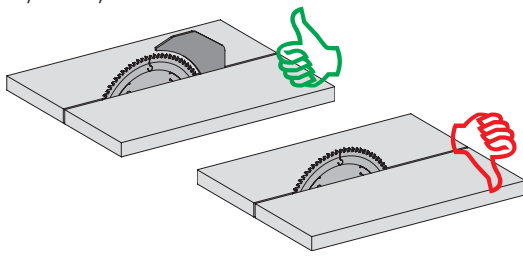

LONGER LIFETIME THANKS TO DIAMOND TIPS Clean your circular saw blades on a regular basis. You will profit from a long-lasting and precise cutting quality and maximize the lifetime of your innovative saw blades many times over.



- It is not recommended to use the saw blades for longitudinal cuts in soft wood and material thicknesses of more than 40mm.
- Do not cut materials with nails, stone and metal parts.
- Chip-free cuts can only be guaranteed in combination with a suitable scoring saw blade.

D mm	B mm	PIN HOLE ⊕⊗	Z	K mm	P mm	α	β		ORDER NO.
160	20	2/6/32	20	2,2	1,6	10°	HR	1	235.160.20H
190	30	2/7/42	24	2,5	2,0	10°	HR	1	235.190.24M
216	30	2/7/42	30	2,5	2,0	10°	HR	1	235.216.30M
250	30	COMBI3	36	2,5	2,0	10°	HR	1	235.250.36M
300	30	COMBI3	44	2,5	2,0	10°	HR	1	235.300.44M

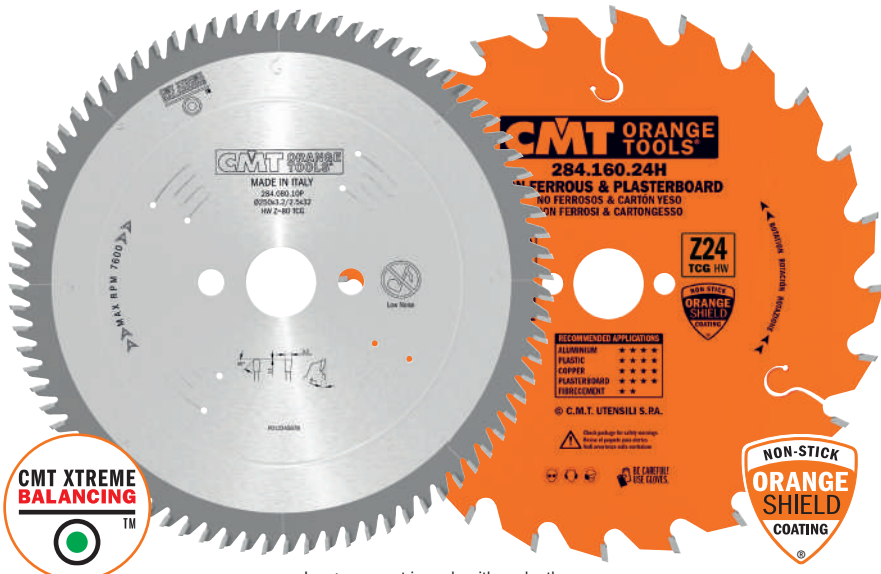

284



NON-FERROUS

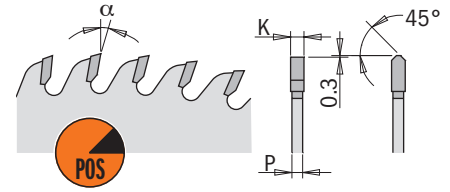

Images are not in scale with each other.

MACHINES

*WITH MEC/MAN WORKPIECE CLAMPING

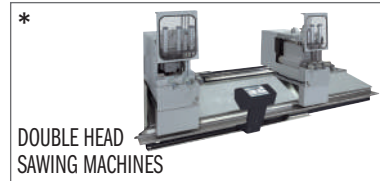

Blade diameter compatibility is contingent on machine type.

MATERIALS

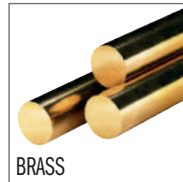
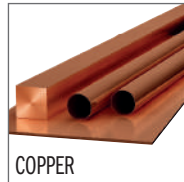
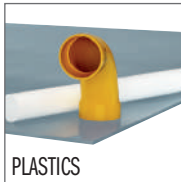

For specific details regarding suggested materials, please check blade label.

284 INDUSTRIAL

NON-STICK ORANGE SHIELD COATING®



D mm	B mm	PIN HOLE	Z	K mm	P mm	α	β	Box	ORDER NO.
160	20	2/6/32	24	2,2	1,6	5°	TCG	10	284.160.24H ●
190	30	2/7/42	30	2,6	2,2	5°	TCG	10	284.190.30M ●
216	30	2/7/42	40	2,6	2,2	5°	TCG	10	284.216.40M ●

● Ideal for FESTOOL® & others

284 XTREME



D mm	B mm	PIN HOLE	Z	K mm	P mm	α	β	Box	ORDER NO.
250	32	2/12/64	80	3,2	2,5	6°	TCG	1	284.080.10P
300	32	2/12/64	96	3,2	2,5	6°	TCG	1	284.096.12P
350	32	2/12/64	84	3,6	3,0	6°	TCG	1	284.092.14P
350	32	2/12/64	108	3,6	3,0	6°	TCG	1	284.108.14P
400	32	2/12/64	96	4,0	3,2	6°	TCG	1	284.096.16P
420	32	2/12/64	96	3,8	3,2	6°	TCG	1	284.096.17P
450	30	2/10/60	108	4,2	3,5	6°	TCG	1	284.108.18M
450	32	2/12/64	108	4,2	3,5	6°	TCG	1	284.108.18P
500	30	2/10/60	120	4,3	3,5	10°	TCG	1	284.120.20M
500	32	2/12/64	120	4,3	3,5	10°	TCG	1	284.120.20P

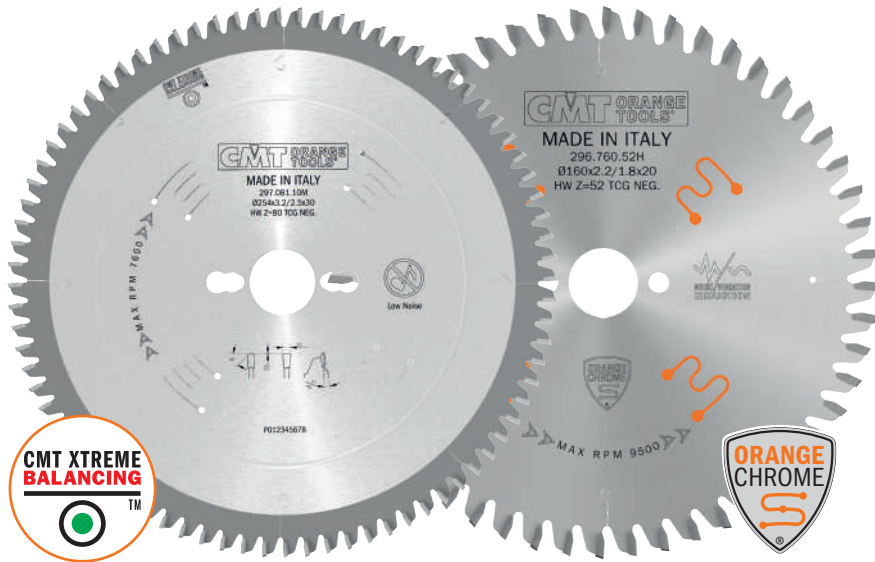

296-297



NON-FERROUS

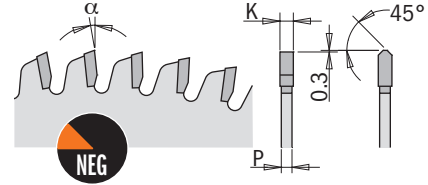

Images are not in scale with each other.

MACHINES



Blade diameter compatibility is contingent on machine type.

MATERIALS

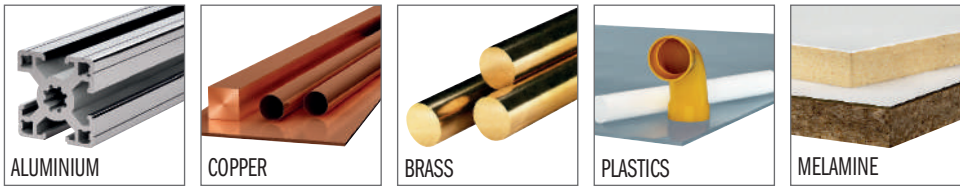

D mm	B mm	PIN HOLE	Z	K mm	P mm	α	β		ORDER NO.		ORDER NO.
160	20	2/6/32	52	2,2	1,8	-5° Neg.	TCG	1	296.760.52H ●		
160	20	2/6/32	52	1,8	1,2	-5° Neg.	TCG	1	296.761.52H ●		
168	20	2/6/32	52	1,8	1,2	-5° Neg.	TCG	1	296.768.52H ●		
216	30	2/7/42	64	2,3	1,6	0°	TCG	1	297.816.64M ●		
250	30	COMBI3	80	3,2	2,5	-6° Neg.	TCG	1			297.080.10M
250	32	2/12/64	80	3,2	2,5	-6° Neg.	TCG	1			297.080.10P
254	30	COMBI3	80	3,2	2,5	-6° Neg.	TCG	1			297.081.10M
260	30	COMBI3	80	3,2	2,5	-6° Neg.	TCG	1			297.080.11M
280	30	COMBI3	64	3,2	2,5	-6° Neg.	TCG	1			297.064.11M
300	30	COMBI3	96	3,2	2,5	-6° Neg.	TCG	1			297.096.12M
300	32	2/12/64	96	3,2	2,5	-6° Neg.	TCG	1			297.096.12P
305	30	COMBI3	96	3,2	2,5	-6° Neg.	TCG	1			297.096.13M
315	30	COMBI3	96	3,2	2,5	-6° Neg.	TCG	1			297.096.23M
330	30	COMBI3	96	3,6	3,0	-6° Neg.	TCG	1			297.096.33M
330	32	COMBI3	96	3,6	3,0	-6° Neg.	TCG	1			297.096.33P
350	30	COMBI3	108	3,6	3,0	-6° Neg.	TCG	1			297.108.14M
350	32	4/12/64	108	3,6	3,0	-6° Neg.	TCG	1			297.108.14P
400	30	2/10/60	120	4,0	3,2	-6° Neg.	TCG	1			297.120.16M
400	32	4/12/64	96	4,0	3,2	-6° Neg.	TCG	1			297.120.16P
400	32	4/12/64	120	4,0	3,2	-6° Neg.	TCG	1			297.120.16P
450	30	2/10/60	96	4,2	3,5	-6° Neg.	TCG	1			297.108.18M
450	30	2/10/60	120	4,2	3,5	-6° Neg.	TCG	1			Y297.140.18M
450	32	2/12/64	96	4,2	3,5	-6° Neg.	TCG	1			297.108.18P
450	32	4/12/64	120	4,2	3,5	-6° Neg.	TCG	1			297.120.18P
500	30	2/10/60	120	4,3	3,5	-6° Neg.	TCG	1			297.120.20M
500	32	2/12/64	120	4,3	3,5	-6° Neg.	TCG	1			297.120.20P

● Ideal for FESTOOL® & others

© Brand names mentioned in CMT products are the property of their respective owners (see back cover)



296-297 INDUSTRIAL



NON-FERROUS

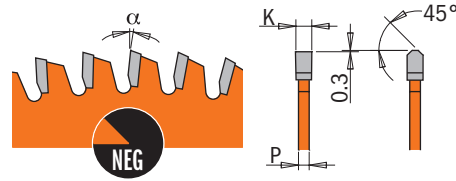

MACHINES



CIRCULAR SAW

MITRE SAW

SLIDE MITRE SAW

TABLE SAW

Blade diameter compatibility is contingent on machine type.

MATERIALS

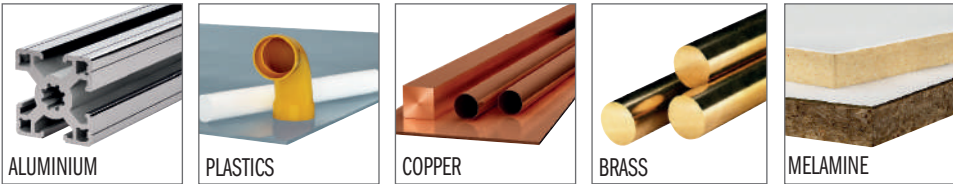

ALUMINIUM

PLASTICS

COPPER

BRASS

MELAMINE

D mm	B mm	PIN HOLE 	Z	K mm	P mm	α	β		ORDER NO.
120	20	2/5,5/30	36	1,8	1,2	-6° Neg.	TCG	10	296.120.36H
160	20	2/6/32	40	2,2	1,6	-6° Neg.	TCG	10	296.160.40H ●
160	20	2/6/32	56	2,2	1,6	-6° Neg.	TCG	10	296.160.56H ●
165	20	2/6/32	40	2,2	1,6	-6° Neg.	TCG	10	296.165.40H
165	20	2/6/32	56	2,2	1,6	-6° Neg.	TCG	10	296.165.56H
180	20	2/6/32	40	2,8	2,2	-6° Neg.	TCG	10	296.180.40H
190	30	2/7/42	40	2,8	2,2	-6° Neg.	TCG	10	296.190.40M
190	30	2/7/42	64	2,8	2,2	-6° Neg.	TCG	10	296.190.64M
190	20 (FESTOOL® FF)	Key 5/7/2,5	64	2,8	2,2	-6° Neg.	TCG	10	296.190.64FF ●
200	30	COMBI3	48	2,8	2,2	-6° Neg.	TCG	10	296.200.48M
210	30	2/7/42	48	2,8	2,2	-6° Neg.	TCG	10	296.210.48M ●
210	30	2/7/42	64	2,8	2,2	-6° Neg.	TCG	10	296.210.64M ●
216	30	2/7/42	64	2,8	2,2	-6° Neg.	TCG	10	297.064.09M ●
216	30	2/7/42	80	2,8	2,2	-6° Neg.	TCG	10	297.080.09M ●
225	30	2/7/42	64	2,8	2,2	-6° Neg.	TCG	10	296.225.64M ●
230	30	2/7/42	48	2,8	2,2	-6° Neg.	TCG	10	296.230.48M ●
235	30	2/7/42	48	2,8	2,2	-6° Neg.	TCG	10	296.235.48M

● Ideal for FESTOOL® & others



276 ITK PLUS®



NON-FERROUS

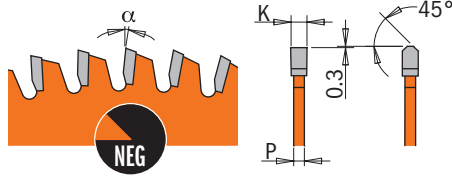

MACHINES

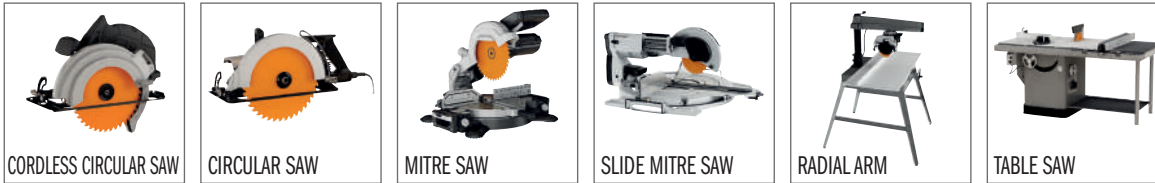

Blade diameter compatibility is contingent on machine type.

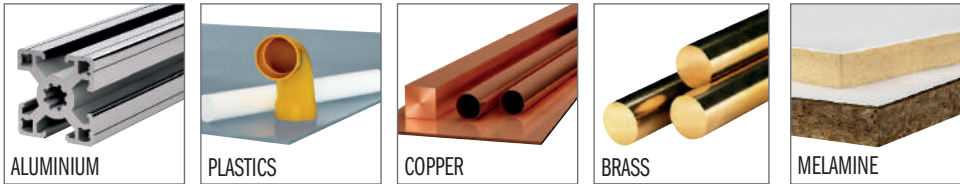

MATERIALS



D mm	B mm	PIN HOLE	Z	K mm	P mm	α	β		ORDER NO.
new 140	20	2/6/32,5	48	1,8	1,2	-6° Neg.	TCG	10	276.140.48H
160	20 (+16)	2/6/32	48	1,8	1,2	-6° Neg.	TCG	10	276.160.48H ●
new 165	20 (+15,87)	2/6/32	56	1,8	1,2	-6° Neg.	TCG	10	276.165.56H
new 168	20	2/6/32	52	1,8	1,2	-5° Neg.	TCG	10	276.168.52H ●
184	20 (+16+15,87)	2/7/42	48	1,8	1,2	-6° Neg.	TCG	10	276.184.48H
190	30 (+20+16)	2/7/42	64	1,8	1,2	-6° Neg.	TCG	10	276.190.64M
210	30 (+25)	2/7/42	64	1,8	1,2	-6° Neg.	TCG	10	276.210.64M ●
216	30	2/7/42	64	2,2	1,6	-6° Neg.	TCG	10	276.216.64M ●
250	30	COMBI3	80	2,6	1,8	-6° Neg.	TCG	10	276.250.80M
300	30	COMBI3	96	2,8	2,0	-6° Neg.	TCG	5	276.300.96M
305	30	COMBI3	96	2,8	2,0	-6° Neg.	TCG	5	276.305.96M

● Ideal for **FESTOOL®** & others

Metal & Steel

MATERIALS	COATING TYPE	
		
STEEL (<500 N/mm ²)	★ ★	★ ★ ★ ★
STEEL (<800 N/mm ²)	★ ★	★ ★ ★
STEEL (<1200 N/mm ²)	★ ★	★ ★ ★ ★
STAINLESS STEEL	★ ★	★ ★ ★ ★
CAST IRON	★ ★	★ ★ ★ ★
ALUMINIUM/ALLOY AL.	★ ★	★ ★ ★ ★
TITANIUM	★	★ ★
BRONZE	NOT RECOMMENDED	★ ★ ★ ★
COPPER	NOT RECOMMENDED	★ ★ ★
BRASS	NOT RECOMMENDED	★ ★ ★
TECHNICAL INFO	VAPO	TiCN
COLOR	BLACK	BROWN - RED
HARDNESS (HV)	800	3200
THICKNESS (µm)	2 - 4	2 - 4
COEFFICIENT OF FRICTION	0.6	0.2
MAX. WORKING TEMPERATURE	350°C	450°C

SUGGESTED SPEED (BW - C/HZ)	
MATERIALS	V (m/min.) MIN. ~ MAX
STEEL (<500 N/mm ²):	30 ~ 60
STEEL (<800 N/mm ²):	25 ~ 40
STEEL (<1200 N/mm ²):	15 ~ 30
STAINLESS STEEL:	15 ~ 30
CAST IRON:	25 ~ 50
ALUMINIUM/ALLOY AL.:	500 ~ 700
TITANIUM:	15 ~ 20
BRONZE:	200 ~ 300
COPPER:	200 ~ 400
BRASS:	400 ~ 600

$$RPM = \frac{1000 \times V \text{ (m/min.)}}{3,14 \times D \text{ (mm)}}$$



Metal & Steel



227 HSS LINE



METAL & STEEL

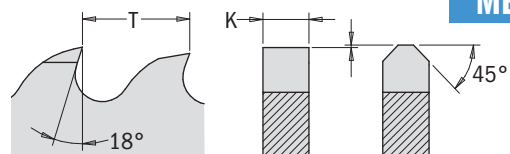

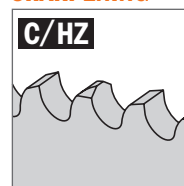

SHARPENING



APPLICATIONS



D mm	B mm	PIN HOLE 	Z	K mm	PITCH T	β	COATING 	ORDER NO.
250	32	2/8/45+2/9/50+2/11/63	128	2,0	T6	C/HZ	VAPO	227.250.128P
275	32	2/8/45+2/9/50+2/11/63	140	2,5	T6	C/HZ	VAPO	227.275.140P
300	32	2/8/45+2/9/50+2/11/63	160	2,5	T6	C/HZ	VAPO	227.300.160P
315	32	2/8/45+2/9/50+2/11/63	160	2,5	T6	C/HZ	VAPO	227.315.160P
350	32	2/8/45+2/9/50+2/11/63	180	2,5	T6	C/HZ	VAPO	227.350.180P



227 HSS LINE



METAL & STEEL

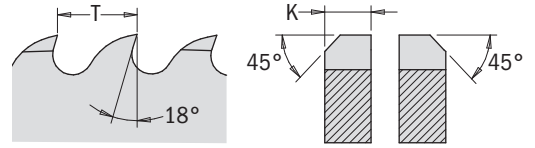

SHARPENING

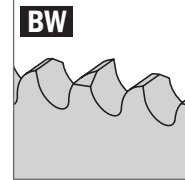

APPLICATIONS



D mm	B mm	PIN HOLE	Z	K mm	PITCH T	β	COATING	ORDER NO.
200	32	2/8/45+2/9/50+2/11/63	160	1,8	T4	BW	VAPO	227.200.160P
225	32	2/8/45+2/9/50+2/11/63	180	1,9	T4	BW	VAPO	227.225.180P
250	32	2/8/45+2/9/50+2/11/63	160	2,0	T5	BW	VAPO	227.250.160P
250	32	2/8/45+2/9/50+2/11/63	200	2,0	T4	BW	VAPO	227.250.200P
275	32	2/8/45+2/9/50+2/11/63	220	2,5	T4	BW	VAPO	227.275.220P
300	32	2/8/45+2/9/50+2/11/63	220	2,5	T4	BW	VAPO	227.300.220P
315	32	2/8/45+2/9/50+2/11/63	240	2,5	T4	BW	VAPO	227.315.240P
350	32	2/8/45+2/9/50+2/11/63	280	2,5	T4	BW	VAPO	227.350.280P

D mm	B mm	PIN HOLE	Z	K mm	PITCH T	β	COATING	ORDER NO.
250	32	2/8/45+2/9/50+2/11/63	200	2,0	T4	BW	TiCN	227.250.700P
275	32	2/8/45+2/9/50+2/11/63	220	2,0	T4	BW	TiCN	227.275.722P
275	32	2/8/45+2/9/50+2/11/63	220	2,5	T4	BW	TiCN	227.275.720P
300	32	2/8/45+2/9/50+2/11/63	220	2,0	T4	BW	TiCN	227.300.722P
300	32	2/8/45+2/9/50+2/11/63	220	2,5	T4	BW	TiCN	227.300.720P
315	32	2/8/45+2/9/50+2/11/63	240	2,5	T4	BW	TiCN	227.315.740P
350	32	2/8/45+2/9/50+2/11/63	280	2,5	T4	BW	TiCN	227.350.780P



HSS
HIGH SPEED STEEL
DMo5

227 HSS LINE



METAL & STEEL

D mm	B mm	PIN HOLE	Z	K mm	β	COATING	ORDER NO.
200	32	2/8/45+2/9/50+2/11/63	0	1,8	Not Sharpened	VAPO	227.200P
225	32	2/8/45+2/9/50+2/11/63	0	1,9	Not Sharpened	VAPO	227.225P
250	32	2/8/45+2/9/50+2/11/63	0	2,0	Not Sharpened	VAPO	227.250P
275	32	2/8/45+2/9/50+2/11/63	0	2,5	Not Sharpened	VAPO	227.275P
300	32	2/8/45+2/9/50+2/11/63	0	2,5	Not Sharpened	VAPO	227.300P
315	32	2/8/45+2/9/50+2/11/63	0	2,5	Not Sharpened	VAPO	227.315P
350	32	2/8/45+2/9/50+2/11/63	0	2,5	Not Sharpened	VAPO	227.350P



226 INDUSTRIAL

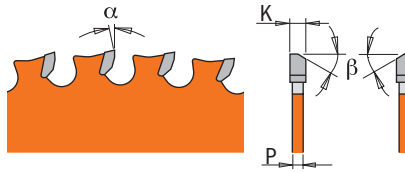

METAL & STEEL

MACHINES



Blade diameter compatibility is contingent on machine type.

MATERIALS

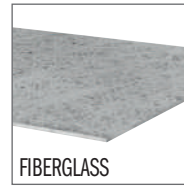
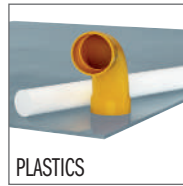

D mm	B mm	PIN HOLE	Z	K mm	P mm	α	β	MAX RPM		ORDER NO.
136	20 (+10)	-	56	1,5	1,2	0°	8° FWF	6000	10	226.136.56H
150	20	-	60	1,6	1,2	0°	8° FWF	6000	10	226.150.60H
160	20 (+16)	2/6/32	60	2,0	1,6	0°	8° FWF	6000	10	226.160.60H ●
165	20	2/6/32	60	1,6	1,2	0°	8° FWF	6000	10	226.165.60H
184	30 (+16+20)	2/7/42	64	2,0	1,6	0°	8° FWF	6000	10	226.184.64M
190	30 (+20)	2/7/42	64	2,0	1,6	0°	8° FWF	6000	10	226.190.64M
210	30	2/7/42	64	2,2	1,8	0°	8° FWF	4500	10	226.210.64M ●
216	30	2/7/42	64	2,2	1,8	0°	8° FWF	3500	10	226.216.64M ●
254	15,87	-	60	2,2	1,8	0°	8° FWF	3000	5	226.060.10
254	30	COMBI3	60	2,2	1,8	0°	8° FWF	3000	5	226.060.10M
305	25,4	-	80	2,2	1,8	0°	8° FWF	2000	5	226.080.12
305	30	COMBI3	80	2,2	1,8	0°	8° FWF	2000	5	226.080.12M
355	25,4	-	90	2,2	1,8	0°	8° FWF	2000	5	226.090.14
355	30	COMBI3	90	2,2	1,8	0°	8° FWF	2000	5	226.090.14M

● Ideal for **FESTOOL**® & others

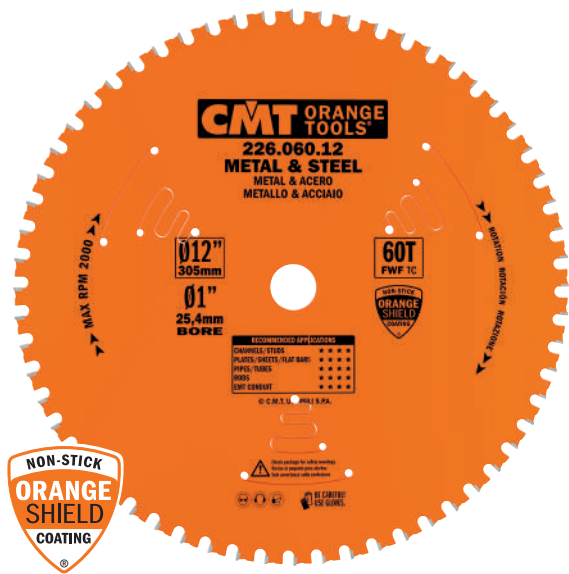

226 INDUSTRIAL

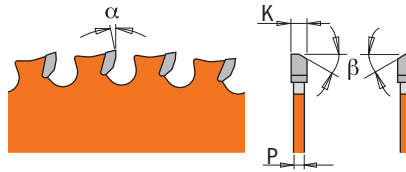

METAL & STEEL

MACHINES



Blade diameter compatibility is contingent on machine type.

MATERIALS



D mm	B mm	PIN HOLE	Z	K mm	P mm	α	β	MAX RPM		ORDER NO.
136	10	-	30	1,5	1,2	0°	8° FWF	6000	10	226.030.05
136	20	-	30	1,5	1,2	0°	8° FWF	6000	10	226.030.05H
150	20	-	32	1,6	1,2	0°	8° FWF	6000	10	226.032.06H
160	20	2/6/32	30	2,0	1,6	0°	8° FWF	6000	10	226.030.06H ●
165	15,87	-	36	1,6	1,2	0°	8° FWF	6000	10	226.036.06
165	20	2/6/32	36	1,6	1,2	0°	8° FWF	6000	10	226.036.06H
165	30	2/7/42	36	1,6	1,2	0°	8° FWF	6000	10	226.036.06M
184	15,87	-	48	2,0	1,6	0°	8° FWF	6000	10	226.048.07
190	30	2/7/42	40	2,0	1,6	0°	8° FWF	6000	10	226.040.07M
203	15,87	-	48	2,2	1,8	0°	8° FWF	4500	10	226.048.08
210	30	2/7/42	48	2,2	1,8	0°	8° FWF	4500	10	226.048.08M ●
216	30	2/7/42	48	2,2	1,8	0°	8° FWF	3500	10	226.047.09M ●
235	30	2/7/42	48	2,2	1,8	0°	8° FWF	3500	10	226.048.09M
254	15,87	-	48	2,2	1,8	0°	8° FWF	3000	5	226.048.10
305	25,4	-	60	2,2	1,8	0°	8° FWF	2000	5	226.060.12
355	25,4	-	72	2,2	1,8	0°	8° FWF	2000	5	226.072.14

● Ideal for **FESTOOL**® & others

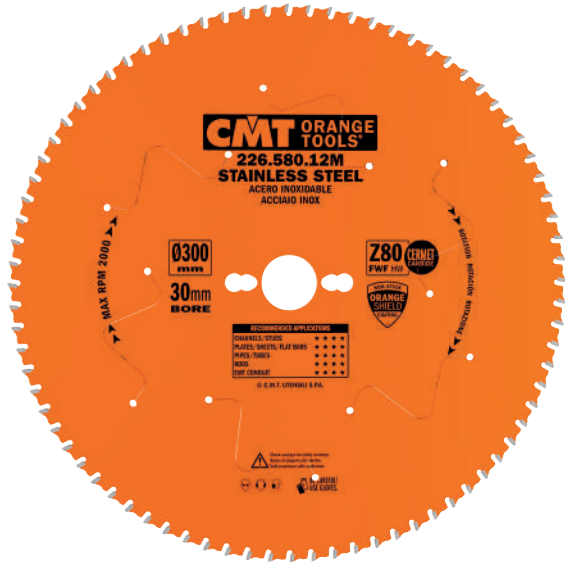

226 INDUSTRIAL

PERFORMANCE

METAL & STEEL

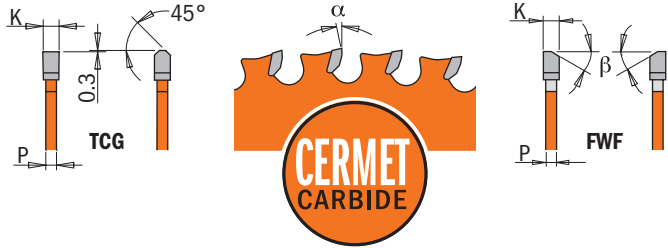

MACHINES

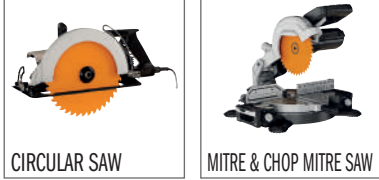

CIRCULAR SAW

MITRE & CHOP MITRE SAW

Blade diameter compatibility is contingent on machine type.

MATERIALS



CHANNELS/STUDS/ANGLES

PLATES/SHEETS/FLAT BARS

PIPES/TUBES

RODS

EMT CONDUIT

Suggested for Stainless steel of common use, such as 302, 303 and 304.

With higher degrees of hardness, performance is not guaranteed (e.g. 316)

D mm	B mm	PIN HOLE	Z	K mm	P mm	α	β	MAX RPM		ORDER NO.
160	20	2/6/32	40	1,8	1,4	0°	TCG	6000	10	226.540.06H ●
184	15,87	-	48	2,0	1,6	0°	TCG	6000	10	226.548.07
190	30	2/7/42	48	1,8	1,4	0°	TCG	6000	10	226.548.07M
216	30	2/7/42	56	1,8	1,4	0°	TCG	3500	10	226.556.09M ●
250	30	COMBI3	72	2,2	1,8	0°	10° FWF	3000	5	226.572.10M
254	15,87	-	72	2,2	1,8	0°	10° FWF	3000	5	226.572.10
300	30	COMBI3	80	2,2	1,8	0°	10° FWF	2000	5	226.580.12M
305	25,4	-	80	2,2	1,8	0°	10° FWF	2000	5	226.580.12
355	25,4	-	90	2,2	1,8	0°	10° FWF	2000	5	226.590.14
355	30	COMBI3	90	2,2	1,8	0°	10° FWF	2000	5	226.590.14M

● Ideal for **FESTOOL®** & others

223 INDUSTRIAL



MULTI-MATERIALS

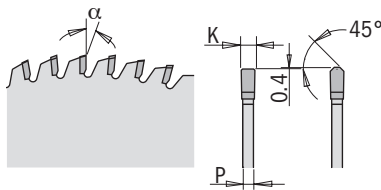

MACHINES



CIRCULAR SAW



MITRE SAW



TABLE SAW



SQUARING

Blade diameter compatibility is contingent on machine type.

MATERIALS



SOLID SURFACE



THICK PLASTICS

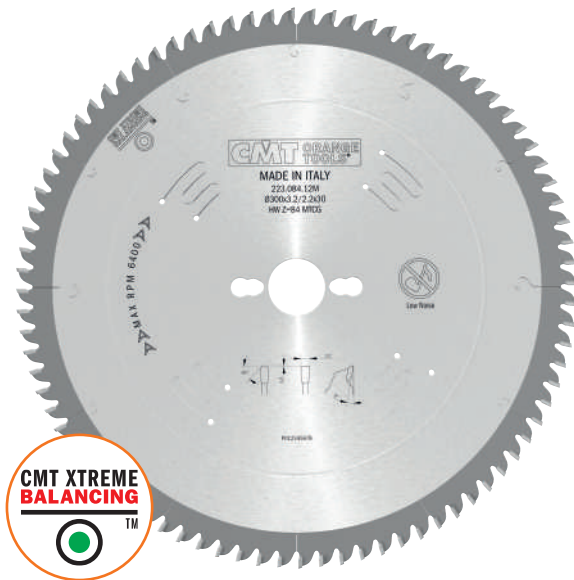

D mm	B mm	PIN HOLE	Z	K mm	P mm	α	β		ORDER NO.
160	20	2/6/32	48	2,2	1,6	0°	MTCG	1	223.048.06H ●
250	30	COMBI3	72	3,2	2,5	0°	MTCG	1	223.072.10M
300	30	COMBI3	84	3,2	2,5	0°	MTCG	1	223.084.12M

● Ideal for **FESTOOL**® & others

Plastics

222 XTREME



MULTI-MATERIALS

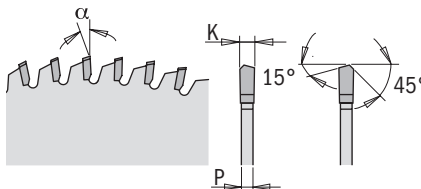

MACHINES



SLIDE MITRE SAW



TABLE SAW



SQUARING

Blade diameter compatibility is contingent on machine type.

MATERIALS

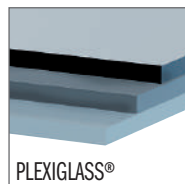

PLEXIGLASS®



THIN PLASTICS



D mm	B mm	PIN HOLE	Z	K mm	P mm	α	β		ORDER NO.
250	30	COMBI3	80	2,8	2,2	-3° Neg.	MATB	1	222.080.10M
300	30	COMBI3	96	2,8	2,2	-3° Neg.	MATB	1	222.096.12M

Dado Grooving



230.5

CMT designed a new Dado Precision Set with the following features:

- New Setting Points for chippers alignment.
- For flat bottom grooves & virtually splinter-free cuts in solid wood, laminates & melamines, veneer plywood.
- Includes shims (plastic & magnetic) and plastic "lock spacers" set for micro-thin adjustability.
- Orange Shield Coating protect from heat, gumming and corrosion.



PERFORMANCE

WOOD

NOT FOR

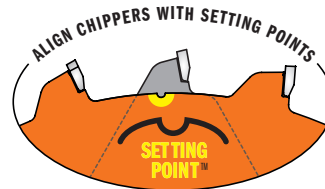

Always use both outside blades. Never use the chippers by themselves, or with only one outside blade. Securely fasten CMT Dado on machine using manufacturer's recommended dado arbor nut.

MATERIALS



MACHINES



230.524.08 SET INCLUDES:

- A - Left Outside Blade (qty: 1)
- B - Right Outside Blade (qty: 1)
- C - Chippers 1/8" (qty: 4)
- D - Spacers 1/16" (qty: 2)
- E - Shims 0.004" (qty: 5)
- F - Shim 0.008" (qty: 1)
- G - Magnetic Shim 0.012" (qty: 1)
- H - Magnetic Shim 0.020" (qty: 1)

SPARE PART SET: 299.000.09

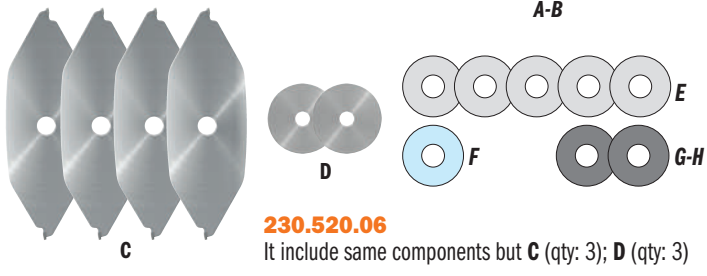

230.520.06 It include same components but C (qty: 3); D (qty: 3)

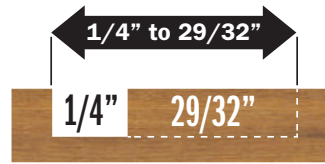

Download instructions sheets from our website

Nominal Widths	1/4"	5/16"	11/32"	3/8"	13/32"	7/16"	15/32"	1/2"	17/32"	9/16"	19/32"	5/8"	21/32"	11/16"	23/32"	3/4"	25/32"	13/16"	27/32"	7/8"	29/32"	
Left Blade	•	•	•	•	•	•	•	•	•	•	•	•	•	•	•	•	•	•	•	•	•	•
Right Blade	•	•	•	•	•	•	•	•	•	•	•	•	•	•	•	•	•	•	•	•	•	•
Chipper 1/8"	0	0	0	1	1	1	1	2	2	2	2	3	3	3	3	4	4	4	4	4	4	4
Spacer 1/16"	0	1	1	0	0	1	1	0	0	1	1	0	0	1	1	0	0	1	1	2	2	2
Shim 0.004"	1	1	0	0	1	0	1	0	0	0	0	0	0	0	0	0	1	0	1	0	1	1
Shim 0.008"	0	0	1	1	0	1	0	1	1	1	1	1	1	1	1	1	0	1	0	1	0	1
Mag. Shim 0.012"	0	0	1	0	1	0	1	0	1	0	1	0	1	0	1	1	1	1	1	1	1	1
Mag. Shim 0.020"	0	0	1	0	1	0	1	0	1	0	1	0	1	0	1	0	1	0	1	0	1	1

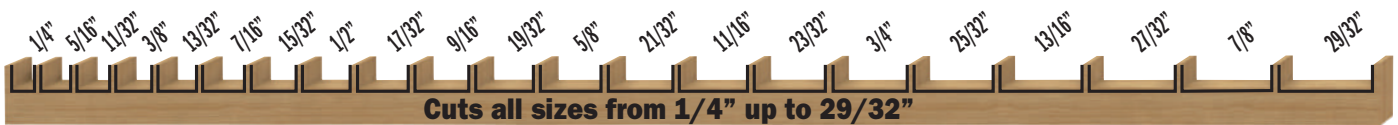

230.524.08

Sturdy reusable carrying case



230.520.06

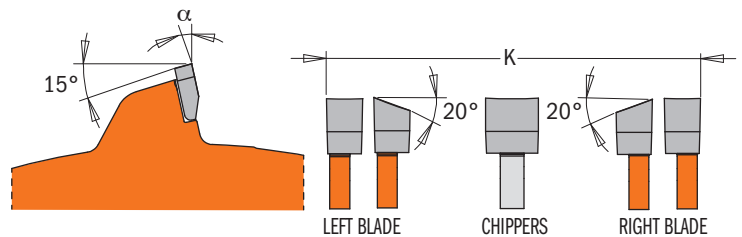

D mm	B mm	Z	α	β	Box	ORDER NO.
152	15,87	20	-12° Neg.	FLAT+ATB	3	230.520.06
203	15,87	24	-12° Neg.	FLAT+ATB	3	230.524.08



230.312 INTERNATIONAL PATENT PENDING

CMT is proud to introduce a brand new Locked Dado Pro Set unlike any other! This is the very first Dado ever deemed UNI EN847 compliant. This means that while the Dado is rotating, the assembled elements will never come into contact with each other! This is possible thanks to unique blade body design and 'never before seen' special "lock spacers".

FEATURES:

- For flat bottom grooves & virtually splinter-free cuts in solid wood, laminates & melamines, veneer plywood.
- Includes shims (plastic & magnetic) and plastic "lock spacers" set for micro-thin adjustability.
- Compatible with most radial arm saws and stationary table saws, including SAWSTOP®.
- Easy pre-assembly out of machine. Once stacked, no alignment necessary.
- Cutting teeth/assembled elements never come in contact each other, even when brake safety system kicks in.



WOOD



Always use both outside blades. Never use the chippers by themselves, or with only one outside blade. Securely fasten CMT Dado on machine using manufacturer's recommended dado arbor nut.

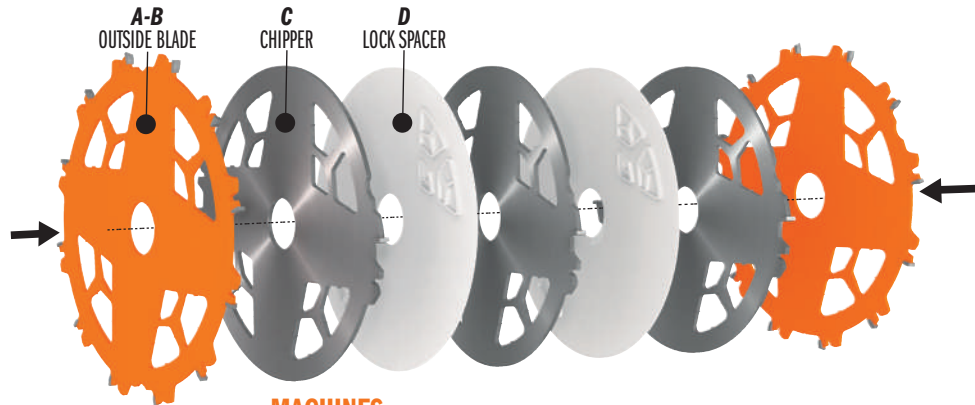
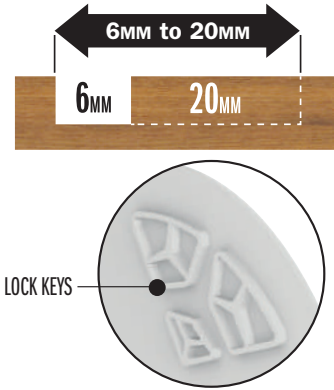

MATERIALS



MACHINES



Sturdy reusable carrying case

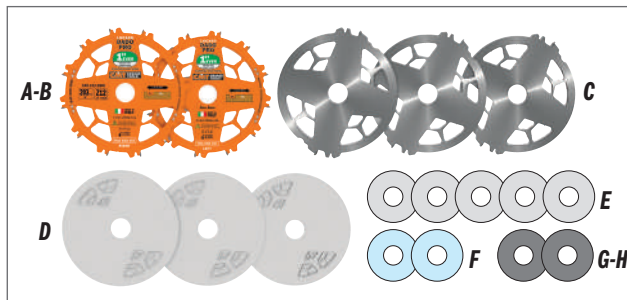

SET INCLUDES:

- A** - Left Outside Blade 203mm (qty: 1)
- B** - Right Outside Blade 203mm (qty: 1)
- C** - Chippers 3.14mm (qty: 3)
- D** - Lock Spacers 1.6mm (qty: 3)
- E** - Shim 0.1mm (qty: 5)
- F** - Shim 0.2mm (qty: 2)
- G** - Magnetic Shim 0.3mm (qty: 1)
- H** - Magnetic Shim 0.5mm (qty: 1)

SPARE PART SET



INSTRUCTIONS ON FRONT & BACK OF INSERT MUST BE USED TOGETHER



Download instructions sheets from our website



Nominal Widths	6mm	7mm	8mm	9mm	10mm	11mm	12mm	13mm	14mm	15mm	16mm	17mm	18mm	19mm	20mm
Left Blade	•	•	•	•	•	•	•	•	•	•	•	•	•	•	•
Right Blade	•	•	•	•	•	•	•	•	•	•	•	•	•	•	•
Chipper 3.14mm	0	0	0	0	1	1	1	2	2	2	2	3	3	3	3
Lock Spacer 1.6mm	0	0	1	1	0	1	1	0	1	1	2	0	1	2	2
Shim 0.1mm	0	0	0	2	1	0	0	0	1	1	0	4	0	0	2
Shim 0.2mm	0	1	2	2	1	1	2	1	0	1	1	2	1	2	2
Mag. Shim 0.3mm	0	1	0	1	0	0	1	0	0	1	1	1	1	0	1
Mag. Shim 0.5mm	0	1	0	1	1	0	1	1	0	1	0	1	1	0	1

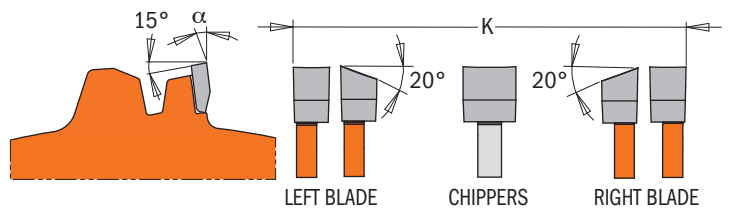

D mm	B mm	Z	α	β	ORDER NO.
203	15,87	12	-12° Neg.	FLAT+ATB	3 230.312.08
203	30	12	-12° Neg.	FLAT+ATB	3 230.312.08M

Spare parts: 299.000.08 Dado Pro Shim Set 230.312.08M
299.000.09 Dado Pro Shim Set 230.312.08



WOOD

240 INDUSTRIAL

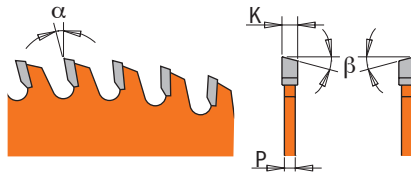

MACHINES



TOUPIE



CHUCK CNC

Blade diameter compatibility is contingent on machine type.

SUITABLE FOR THESE CNC CHUCKS:



183.410.30



183.420.30

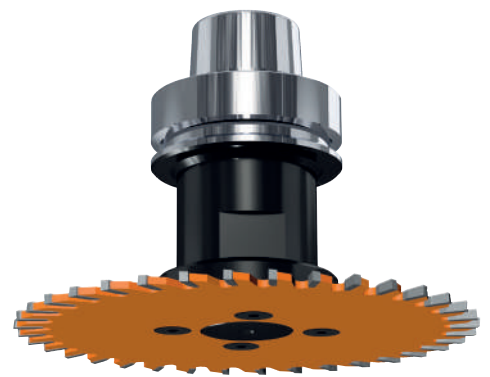

APPLICATIONS



GROOVING



CROSS

MATERIALS



WOOD



PLYWOOD



MELAMINE

D mm	B mm	PIN HOLE	Z	K mm	P mm	α	β		ORDER NO.
150	30	4/6,5 - 12/48 45°	36	3,0	2,2	5°	5°ATB	10	240.150.030M
150	30	4/6,5 - 12/48 45°	36	4,0	3,0	5°	5°ATB	10	240.150.040M
150	30	4/6,5 - 12/48 45°	36	5,0	3,0	5°	5°ATB	10	240.150.050M
150	30	4/6,5 - 12/48 45°	36	6,0	3,0	5°	5°ATB	10	240.150.060M

240 INDUSTRIAL



WOOD

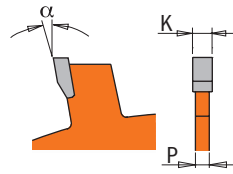

! The new design allows blades stacking with different kerf thickness (see examples of stacking), subject to safety regulations in force in your area.



MACHINES



Blade diameter compatibility is contingent on machine type.

APPLICATIONS



MATERIALS



D mm	B mm	PIN HOLE	Z	K mm	P mm	α	β		ORDER NO.
150	30	-	12	2,0	1,4	15°	FLAT	10	240.020.06M
150	35	-	12	2,0	1,4	15°	FLAT	10	240.020.06R
150	30	-	12	3,0	2,0	15°	FLAT	10	240.030.06M
150	35	-	12	3,0	2,0	15°	FLAT	10	240.030.06R
150	30	-	12	4,0	3,0	15°	FLAT	10	240.040.06M
150	35	-	12	4,0	3,0	15°	FLAT	10	240.040.06R
150	30	-	12	5,0	3,0	15°	FLAT	10	240.050.06M
150	35	-	12	5,0	3,0	15°	FLAT	10	240.050.06R
150	30	-	12	6,0	3,0	15°	FLAT	10	240.060.06M
150	35	-	12	6,0	3,0	15°	FLAT	10	240.060.06R
180	30	-	18	3,0	2,0	15°	FLAT	10	240.030.07M
180	35	-	18	3,0	2,0	15°	FLAT	10	240.030.07R
180	30	-	18	4,0	3,0	15°	FLAT	10	240.040.07M
180	35	-	18	4,0	3,0	15°	FLAT	10	240.040.07R
180	30	-	18	5,0	3,0	15°	FLAT	10	240.050.07M
180	35	-	18	5,0	3,0	15°	FLAT	10	240.050.07R
180	30	-	18	6,0	3,0	15°	FLAT	10	240.060.07M
180	35	-	18	6,0	3,0	15°	FLAT	10	240.060.07R

Grooving System

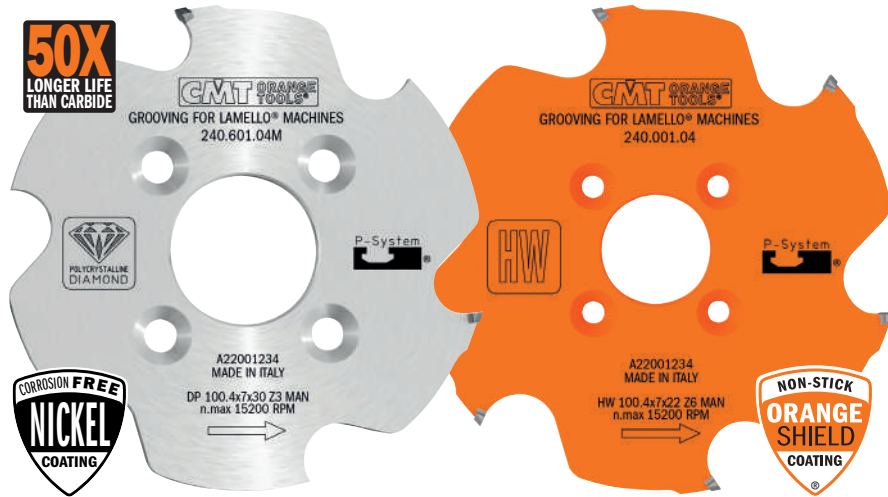

240



WOOD

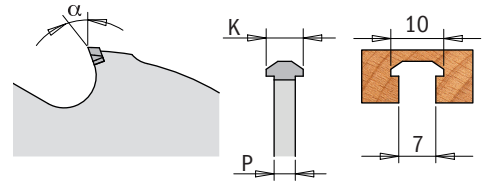

MACHINES



APPLICATIONS



MATERIALS

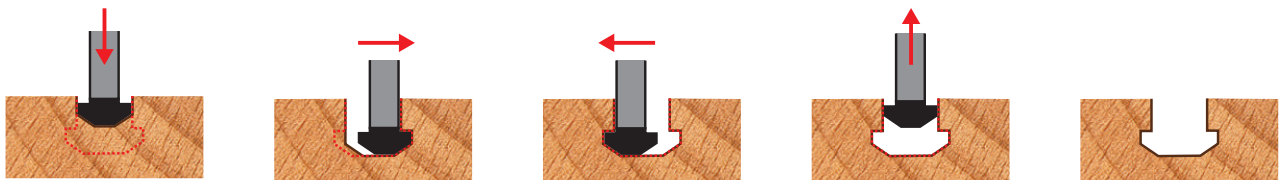
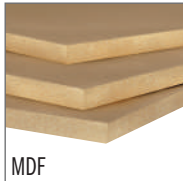

240 XTREME



D mm	B mm	TEETH MATERIAL	MACHINE	PIN HOLE	Z	K mm	P mm	α	β	COATING TYPE	BOX	ORDER NO.
100,4	22	DP	LAMELLO® ZETA P®	4/4,5 - 9,5/36	3	7	4	20°	TCG	NICKEL	1	240.601.04
100,4	30	DP	CNC	4/6,6 - 12/48	3	7	4	20°	TCG	NICKEL	1	240.601.04M

240 INDUSTRIAL



D mm	B mm	TEETH MATERIAL	MACHINE	PIN HOLE	Z	K mm	P mm	α	β	COATING TYPE	BOX	ORDER NO.
100,4	22	HW	LAMELLO® ZETA P®	4/4,5 - 9,5/36	6	7	4	20°	TCG	ORANGE SHIELD	10	240.001.04



240-241 INDUSTRIAL



WOOD

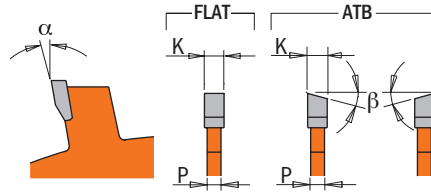

MACHINES



APPLICATIONS

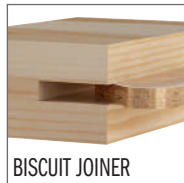

MATERIALS

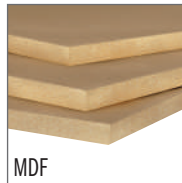

D mm	B mm	PIN HOLE	Z	K mm	P mm	α	β		ORDER NO.
100	22	4/4,5 - 9,5/36	6	3,96	3,0	18°	10° ATB	10	240.006.04
100	22	4/4,5 - 9,5/36	8	3,96	3,0	15°	10° ATB	10	240.008.04
100	22	-	8	3,96	3,1-3,8	15°	FLAT	10	241.008.04 ●

● Ideal for VIRUTEX®



240.004.04 X-TREME



WOOD

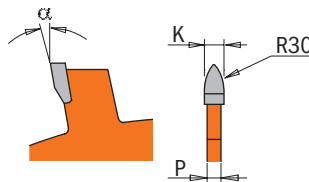

MACHINES



APPLICATIONS



MATERIALS



D mm	B mm	PIN HOLE	MACHINE	Z	K mm	P mm	α	β		ORDER NO.
100	22	4/4,5 - 9,5/36	LAMELLO®	4	8,0	6,0	18°	R30	1	240.004.04



298 ITK⁺ PLUS®

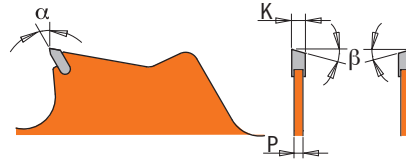

MULTI-MATERIALS



SECURED TOOTH – MORE RESISTANT TO ACCIDENTAL CONTACT

Teeth are welded deep inside blade body which significantly reduces breakage caused by accidental contact with terrain, rocks or stones, masonry work, metal parts, etc.; avoid all contact with these elements wherever possible.

HEAVY DUTY PLATE – THIN, LIGHT AND STRONG

Cut from the finest steel. Remarkably thin kerf and specifically designed perforations considerably reduce blade weight thereby reducing tool workload.

SAFETY WARNING

Circular saw blades are suitable for thinning brush and cutting small trees up to a diameter of 5 cm (2 in) in thickness. Do not attempt to cut trees with larger diameters, since the blade may catch or jerk the clearing saw forward. This may cause damage to the blade or loss of control of the power tool and result in serious injury. Use a chain saw for such work. The operator shall ensure, while working, that no persons or animals come within 15 meters (50 feet) of the tool while in operation. Inspect the work area: remove stones, rocks, pieces of metal and other solid objects which could be thrown by the cutting attachment causing damage to objects or injury to those in close proximity. To reduce the risk of blade/teeth breakage, avoid all contact with terrain, rocks or stones, masonry work, metal parts, etc.

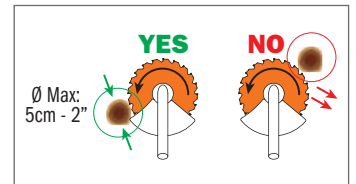

MACHINES



BRUSH CUTTER

MATERIALS



BUSHES & SMALL TREES
(up to a diameter of Ø5 cm)



GRASS

D mm	B mm	RPM max	Z	K mm	P mm	α	β		ORDER NO.
250	25,4 (+20)	12.000	20	2,0	1,4	2°	8° ATB	10	298.250.20
250	25,4 (+20)	12.000	40	2,0	1,4	2°	8° ATB	10	298.250.40

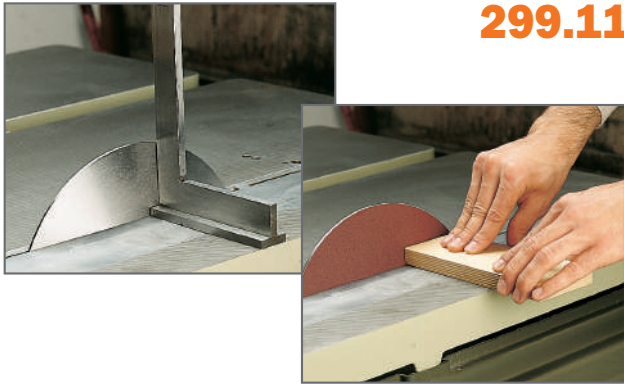

299.11

If you're looking for fast and easy saw alignment and balancing, the cut calibration and sanding disk is for you. First, mount your calibration and sanding disk in your table saw and line it up with a square for accuracy. Then, remove the calibration and sanding disk and mount your saw blade for true precise cuts. You can also use the calibration and sanding disk as a sander by simply attaching self-stick sandpaper and installing the disk in your table saw.



D mm	B mm	P mm		ORDER NO.
200	30	2,8	10	299.111.00M
250	30	2,8	10	299.112.00M

Saw Blades Stabilizers



299.10

The CMT blade stabilizer virtually eliminates rim vibration to make cleaner, straighter cuts and extend the life of your CMT saw blade. It also helps lessen noise caused by vibration during cutting.



DESCRIPTION	D mm	B mm	P mm		ORDER NO.
Stabilizer (2 pcs.) for Ø200mm	75	30	3,0	5	299.101.00M
Stabilizer (2 pcs.) for Ø250mm	125	30	3,0	5	299.102.00M
Stabilizer (2 pcs.) for Ø300mm	152	30	3,0	5	299.103.00M

NOTE: for use on stationary saws only. Each order includes 2 stabilizers.

Reduction Rings for Saw Blades

299

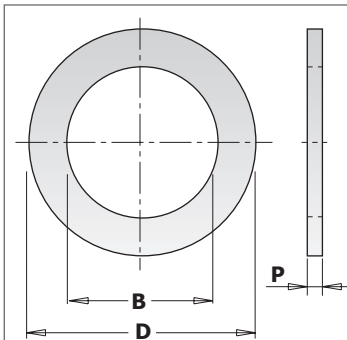

D mm	B mm	P mm		ORDER NO.	D mm	B mm	P mm		ORDER NO.
15,87	10	1,2	10	299.218.00	30	15,87	2,0	10	299.303.00
15,87	12,7	1,2	10	299.217.00	30	16	1,2	10	299.451.00
20	12,7	1,2	10	299.221.00	30	16	1,4	10	299.223.00
20	12,7	1,6	10	299.401.00	30	16	2,0	10	299.226.00
20	13	1,6	10	299.402.00	30	18	1,4	10	299.232.00
20	15	1,6	10	299.403.00	30	19,05	1,4	10	299.241.00
20	15,87	1,4	10	299.243.00	30	19,05	2,0	10	299.305.00
20	16	1,0	10	299.351.00	30	20	1,2	10	299.452.00
20	16	1,2	10	299.222.00	30	20	1,4	10	299.224.00
20	16	1,6	10	299.404.00	30	20	2,0	10	299.227.00
20	18	1,4	10	299.236.00	30	22	1,4	10	299.231.00
22,2	15	1,4	10	299.237.00	30	25	1,2	10	299.453.00
22,2	16	1,4	10	299.242.00	30	25	1,4	10	299.225.00
22,2	20	1,4	10	299.238.00	30	25	2,0	10	299.228.00
25	16	2,0	10	299.301.00	30	25,4	1,6	10	299.405.00
25	20	2,0	10	299.302.00	30	25,4	2,0	10	299.212.00
25,4	15,87	1,4	10	299.216.00	32	20	2,0	10	299.309.00
25,4	19,05	1,4	10	299.213.00	32	30	2,0	10	299.229.00
25,4	20	1,4	10	299.214.00	35	20	2,0	10	299.311.00
25,4	20	2,3	10	299.220.00	35	25	2,0	10	299.312.00
25,4	22	1,4	10	299.215.00	35	25,4	2,0	10	299.313.00
25,4	22,2	1,4	10	299.239.00	35	30	2,0	10	299.230.00
25,4	22,2	2,3	10	299.219.00	35	32	2,0	10	299.233.00
30	15	1,4	10	299.240.00	40	30	2,0	10	299.316.00
30	15,87	1,4	10	299.211.00					

Saw Blade Index

D mm	B mm	Z	K mm	P mm	α	β	MATERIALS APPLICATION	PERFORMANCE	ORDER NO.	PAGE
50	10	20	1,1	0,8	15°	10° ATB	WOOD	★★★	273.050.20D	37
70	20	8+8	2,8-3,6	-	12°	FLAT	WOOD	★★★★★	289.070.16H	50
80	10	36	1,6	1,0	15°	10° ATB	WOOD	★★★	273.080.36D	37
80	20	12	3,1-3,6	2,2	10°	CO+FLAT	WOOD	★★★★★	S288.080.12H	51
80	20	10+10	2,8-3,6	-	12°	FLAT	WOOD	★★★★★	289.080.20H	50
85	15	6	1,8	1,4	12°	TCG	MULTI-MATERIALS	★★★	236.085.06G	13
86	15	24	1,1	0,7	12°	5° ATB	WOOD	★★	K02403	14
100	20	10+10	2,8-3,6	-	12°	FLAT	WOOD	★★★★★	289.100.20H	50
100	20	20	3,1-4,0	2,5	5°	CO+5° ATB	WOOD	★★★★★	288.100.20H	51
100	22	4	8,0	6,0	18°	R30	WOOD	★★★★★	240.004.04	69
100	22	6	3,96	3,0	18°	10° ATB	WOOD	★★★★	240.006.04	69
100	22	8	3,96	3,0	15°	10° ATB	WOOD	★★★★	240.008.04	69
100	22	8	3,96	3,1-3,8	15°	FLAT	WOOD	★★★★	241.008.04	69
100	22	10+10	2,8-3,6	-	12°	FLAT	WOOD	★★★★★	289.100.20K	50
100	22	20	3,1-4,0	2,5	5°	CO+5° ATB	WOOD	★★★★★	288.100.20K	51
100,4	22	3	7	4	20°	TCG	WOOD	★★★★★	240.601.04	68
100,4	22	6	7	4	20°	TCG	WOOD	★★★★	240.001.04	68
100,4	30	3	7	4	20°	TCG	WOOD	★★★★★	240.601.04M	68
115	22,2 (+9,5+15,87)	-	-	-	-	-	MULTI-MATERIALS	-	286.115.01	12
115	22,2 (+9,5+15,87)	-	-	-	-	-	MULTI-MATERIALS	-	286.115.61	12
115	9,5	24	1,5	1,0	20°	10° ATB + 8° Shear	WOOD	★★★	272.115.24	31
120	20	12+12	2,8-3,6	-	12°	FLAT	WOOD	★★★★★	289.120.24H	50
120	20	18	1,8	1,2	15°	15° ATB	WOOD	★★★★	291.120.18H	26
120	20	20	3,1-3,7	2,2	5°	CONICAL	WOOD	★★★★★	238.120.20H	52
120	20	24	3,1-4,0	2,5	5°	CO+5° ATB	WOOD	★★★★★	288.120.24H	51
120	20	24	3,4-4,2	2,5	5°	CO+5° ATB	WOOD	★★★★★	288.120.24H1	51
120	20	36	1,8	1,2	-6° Neg.	TCG	NON-FERROUS	★★★★	296.120.36H	56
120	20	40	1,8	1,2	10°	15° ATB	WOOD	★★★★	292.120.40H	30
120	22	12+12	2,8-3,6	-	12°	FLAT	WOOD	★★★★★	289.120.24K	50
120	22	24	3,1-4,0	2,5	5°	CO+5° ATB	WOOD	★★★★★	288.120.24K	51
120	50	12+12	2,8-3,6	-	12°	FLAT	WOOD	★★★★★	289.120.24T	50
125	20	12+12	2,8-3,6	-	12°	FLAT	WOOD	★★★★★	289.125.24H	50
125	20	20	2,4	1,4	15°	15° ATB	WOOD	★★★★	291.125.20H	26
125	20	20	3,1-3,7	2,2	5°	CONICAL	WOOD	★★★★★	238.125.20H	52
125	20	24	3,1-4,0	2,5	5°	CO+5° ATB	WOOD	★★★★★	288.125.24H	51
125	20	24	3,4-4,2	2,5	5°	CO+5° ATB	WOOD	★★★★★	288.125.24H1	51
125	20	24	4,3-5,5	3,2	10°	CO+FLAT	WOOD	★★★★★	288.125.24H2	51
125	20	36	2,4	1,4	15°	15° ATB	WOOD	★★★★	292.125.36H	30
125	22	12+12	2,8-3,6	-	12°	FLAT	WOOD	★★★★★	289.125.24K	50
125	22	24	3,1-4,0	2,5	5°	CO+5° ATB	WOOD	★★★★★	288.125.24K	51
125	45	24	4,3-5,5	3,2	10°	CO+FLAT	WOOD	★★★★★	288.125.24Q	51
125	22,2	7	2,0	1,4	5°	TCG	MULTI-MATERIALS	★★★	236.125.07	13
125	22,2 (+20+15,87)	-	-	-	-	-	MULTI-MATERIALS	-	286.125.01	12
125	22,2 (+20+15,87)	-	-	-	-	-	MULTI-MATERIALS	-	286.125.61	12
130	20	20	2,4	1,4	15°	15° ATB	WOOD	★★★★	291.130.20H	26
130	20	36	2,4	1,4	15°	15° ATB	WOOD	★★★★	292.130.36H	30
136	10	30	1,5	1,2	0°	8° FWF	METAL & STEEL	★★★★	226.030.05	61
136	20	18	1,5	1,0	15°	15° ATB	WOOD	★★	K13618H-X10	14
136	20	30	1,5	1,2	0°	8° FWF	METAL & STEEL	★★★★	226.030.05H	61
136	20 (+10)	18	1,5	1,0	20°	10° ATB + 8° Shear	WOOD	★★★	271.136.18H	27
136	20 (+10)	36	1,5	1,0	18°	10° ATB + 8° Shear	WOOD	★★★	272.136.36H	31
136	20 (+10)	56	1,5	1,2	0°	8° FWF	METAL & STEEL	★★★★	226.136.56H	60
140	20	20	2,4	1,4	15°	15° ATB	WOOD	★★★★	291.140.20H	26
140	20	24	1,8	1,2	15°	15° ATB + 8° Shear	WOOD	★★★	271.140.24H	27
140	20	36	2,4	1,4	15°	15° ATB	WOOD	★★★★	292.140.36H	30
140	20	42	1,8	1,2	5°	15° ATB + 8° Shear	WOOD	★★★	272.140.42H	31
140	20	48	1,8	1,2	-6° Neg.	TCG	NON-FERROUS	★★★	276.140.48H	57

Saw Blade Index

D mm	B mm	Z	K mm	P mm	α	β	MATERIALS APPLICATION	PERFORMANCE	ORDER NO.	PAGE
150	20	12	2,4	1,4	20°	10° ATB	WOOD	★★★★	290.150.12H	22
150	20	32	1,6	1,2	0°	8° FWF	METAL & STEEL	★★★★	226.032.06H	61
150	20	40	2,4	1,4	15°	15° ATB	WOOD	★★★★	292.150.40H	30
150	20	60	1,6	1,2	0°	8° FWF	METAL & STEEL	★★★★	226.150.60H	60
150	30	12	2,0	1,4	15°	FLAT	WOOD	★★★★	240.020.06M	67
150	30	12	3,0	2,0	15°	FLAT	WOOD	★★★★	240.030.06M	67
150	30	12	4,0	3,0	15°	FLAT	WOOD	★★★★	240.040.06M	67
150	30	12	5,0	3,0	15°	FLAT	WOOD	★★★★	240.050.06M	67
150	30	12	6,0	3,0	15°	FLAT	WOOD	★★★★	240.060.06M	67
150	30	36	3,0	2,2	5°	5° ATB	WOOD	★★★★	240.150.030M	66
150	30	36	4,0	3,0	5°	5° ATB	WOOD	★★★★	240.150.040M	66
150	30	36	5,0	3,0	5°	5° ATB	WOOD	★★★★	240.150.050M	66
150	30	36	6,0	3,0	5°	5° ATB	WOOD	★★★★	240.150.060M	66
150	30	48	3,2	2,2	5°	15° ATB	WOOD	★★★★	285.048.06M	30
150	35	12	2,0	1,4	15°	FLAT	WOOD	★★★★	240.020.06R	67
150	35	12	3,0	2,0	15°	FLAT	WOOD	★★★★	240.030.06R	67
150	35	12	4,0	3,0	15°	FLAT	WOOD	★★★★	240.040.06R	67
150	35	12	5,0	3,0	15°	FLAT	WOOD	★★★★	240.050.06R	67
150	35	12	6,0	3,0	15°	FLAT	WOOD	★★★★	240.060.06R	67
150	45	36	4,3-5,5	3,2	10°	CO+FLAT	WOOD	★★★★★	288.150.36Q	51
150	20 (+16)	24	2,4	1,4	15°	15° ATB	WOOD	★★★★	291.150.24H	26
150	20 (+16)	24	1,5	1,0	18°	10° ATB + 8° Shear	WOOD	★★★	271.150.24H	27
150	20 (+16)	40	1,5	1,0	16°	10° ATB + 8° Shear	WOOD	★★★	272.150.40H	31
152	15,87	20	-	-	-12° Neg.	FLAT+ATB	WOOD	★★★★★	230.520.06	64
160	16	12	2,2	1,6	20°	10° ATB	WOOD	★★★★	290.160.12E	22
160	20	4	2,4	1,8	12°	TCG	MULTI-MATERIALS	★★★	236.160.04H	13
160	20	10	2,4	1,8	5°	TCG	MULTI-MATERIALS	★★★	236.160.10H	13
160	20	10	2,4	1,8	5°	TCG	MULTI-MATERIALS	★★	K160-10HD	15
160	20	20	2,2	1,6	10°	HR	MULTI-MATERIALS	★★★★★	235.160.20H	53
160	20	24	2,3	1,2	5°	5° ATB	WOOD & NAILS	★★★★★	286.760.24H	11
160	20	24	2,2	1,6	15°	15° ATB	WOOD	★★★★	291.160.24H	26
160	20	24	2,2	1,6	5°	TCG	NON-FERROUS	★★★★	284.160.24H	54
160	20	24	2,2	1,4	15°	15° ATB	WOOD	★★	K16024H	14
160	20	24	2,2	1,4	15°	15° ATB	WOOD	★★	K16024H-X10	14
160	20	28	2,2	1,6	15°	10° ATB	WOOD	★★★★	285.160.28H	26
160	20	30	2,0	1,6	0°	8° FWF	METAL & STEEL	★★★★	226.030.06H	61
160	20	34	2,6	1,8	10°	HDF	WOOD	★★★★	287.034.06H	35
160	20	40	2,2	1,6	10°	15° ATB	WOOD	★★★★	292.160.40H	30
160	20	40	2,2	1,6	-6° Neg.	TCG	NON-FERROUS	★★★★	296.160.40H	56
160	20	40	1,8	1,4	0°	TCG	METAL & STEEL	★★★★	226.540.06H	62
160	20	40	2,2	1,4	10°	15° ATB	WOOD	★★	K16040H	14
160	20	40	2,2	1,4	10°	15° ATB	WOOD	★★	K16040H-X10	14
160	20	48	2,2	1,6	5°	15° ATB	WOOD	★★★★	285.160.48H	30
160	20	48	2,2	1,6	5°	12° ATB	WOOD	★★★★★	285.760.48H	32
160	20	48	1,8	1,2	5°	12° ATB	WOOD	★★★★★	285.761.48H	32
160	20	48	2,2	1,6	4°	TCG	WOOD	★★★★★	281.760.48H	42
160	20	48	2,2	1,6	5°	TCG	WOOD	★★★★	281.160.48H	47
160	20	48	2,2	1,6	0°	MTCG	MULTI-MATERIALS	★★★★★	223.048.06H	63
160	20	52	1,8	1,2	-5° Neg.	TCG	WOOD	★★★★★	281.761.52H	46
160	20	52	2,2	1,8	-5° Neg.	TCG	NON-FERROUS	★★★★★	296.760.52H	55
160	20	52	1,8	1,2	-5° Neg.	TCG	NON-FERROUS	★★★★★	296.761.52H	55
160	20	56	2,2	1,6	15°	15° ATB	WOOD	★★★★	292.160.56H	36
160	20	56	2,2	1,6	-3° Neg.	TCG	WOOD	★★★★	281.161.56H	47
160	20	56	2,2	1,6	-6° Neg.	TCG	NON-FERROUS	★★★★	296.160.56H	56
160	30	40	2,2	1,6	10°	15° ATB	WOOD	★★★★	292.160.40M	30
160	45	36	4,3-5,5	3,2	10°	CO+FLAT	WOOD	★★★★★	288.160.36Q	51
160	55	36	4,3-5,5	3,2	10°	CO+FLAT	WOOD	★★★★★	288.160.360	51

Saw Blade Index

D mm	B mm	Z	K mm	P mm	α	β	MATERIALS APPLICATION	PERFORMANCE	ORDER NO.	PAGE
160	20 (+16)	60	2,0	1,6	0°	8° FWF	METAL & STEEL	★★★★	226.160.60H	60
160	20 (+16)	12	2,2	1,6	20°	10° ATB	WOOD	★★★★	290.160.12H	22
160	20 (+16)	24	1,8	1,2	18°	10° ATB + 8° Shear	WOOD	★★★	271.160.24H	27
160	20 (+16)	40	1,8	1,2	16°	10° ATB + 8° Shear	WOOD	★★★	272.160.40H	31
160	20 (+16)	48	1,8	1,2	-6° Neg.	TCG	NON-FERROUS	★★★	276.160.48H	57
160	20 (+16)	56	1,8	1,2	12°	10° ATB + 8° Shear	WOOD	★★★	273.160.56H	37
160	20 (VIRUTEX®)	40	2,2	1,6	10°	TCG	WOOD	★★★★	281.160.40H	47
160	30 (+16)	24	2,2	1,6	15°	15° ATB	WOOD	★★★★	291.160.24M	26
165	20	24	2,3	1,2	5°	5° ATB	WOOD & NAILS	★★★★★	286.765.24H	11
165	20	24	2,2	1,6	15°	15° ATB	WOOD	★★★★	291.165.24H	26
165	20	24	1,7	1,1	15°	15° ATB	WOOD	★★	K16524H	14
165	20	24	1,7	1,1	15°	15° ATB	WOOD	★★	K16524H-X10	14
165	20	36	1,6	1,2	0°	8° FWF	METAL & STEEL	★★★★	226.036.06H	61
165	20	40	2,2	1,6	10°	15° ATB	WOOD	★★★★	292.165.40H	30
165	20	40	2,2	1,6	-6° Neg.	TCG	NON-FERROUS	★★★★	296.165.40H	56
165	20	40	1,7	1,1	15°	15° ATB	WOOD	★★	K16540H-X10	14
165	20	52	1,8	1,2	-5° Neg.	TCG	WOOD	★★★★★	281.766.52H	46
165	20	56	2,2	1,6	15°	15° ATB	WOOD	★★★★	292.165.56H	36
165	20	56	2,2	1,6	-3° Neg.	TCG	WOOD	★★★★	281.166.56H	47
165	20	56	2,2	1,6	-6° Neg.	TCG	NON-FERROUS	★★★★	296.165.56H	56
165	20	60	1,6	1,2	0°	8° FWF	METAL & STEEL	★★★★	226.165.60H	60
165	30	24	2,6	1,6	15°	15° ATB	WOOD	★★★★	291.165.24M	26
165	30	24	1,7	1,1	18°	10° ATB + 8° Shear	WOOD	★★★	271.165.24M	27
165	30	36	1,6	1,2	0°	8° FWF	METAL & STEEL	★★★★	226.036.06M	61
165	30	40	2,6	1,6	10°	15° ATB	WOOD	★★★★	292.165.40M	30
165	15,87	36	1,6	1,2	0°	8° FWF	METAL & STEEL	★★★★	226.036.06	61
165	20 (+15,87)	4	1,8	1,4	12°	TCG	MULTI-MATERIALS	★★★	236.165.04H	13
165	20 (+15,87)	10	1,8	1,4	5°	TCG	MULTI-MATERIALS	★★★	236.165.10H	13
165	20 (+15,87)	24	1,7	1,1	18°	10° ATB + 8° Shear	WOOD	★★★	271.165.24H	27
165	20 (+15,87)	36	1,7	1,1	20°	10° ATB + 8° Shear	WOOD	★★★	272.165.36H	31
165	20 (+15,87)	56	1,6	1,0	12°	15° ATB + 8° Shear	WOOD	★★★	273.165.56H	37
165	20 (+15,87)	56	1,8	1,2	-6° Neg.	TCG	NON-FERROUS	★★★	276.165.56H	57
168	20	10	1,8	1,2	5°	TCG	MULTI-MATERIALS	★★★	236.168.10H	13
168	20	28	1,8	1,2	15°	15° ATB + 8° Shear	WOOD	★★★	271.168.28H	27
168	20	42	1,8	1,2	10°	15° ATB + 8° Shear	WOOD	★★★	272.168.42H	31
168	20	48	1,8	1,2	5°	12° ATB	WOOD	★★★★★	285.768.48H	32
168	20	52	1,8	1,2	-5° Neg.	TCG	WOOD	★★★★★	281.768.52H	46
168	20	52	1,8	1,2	-5° Neg.	TCG	NON-FERROUS	★★★★★	296.768.52H	55
168	20	52	1,8	1,2	-5° Neg.	TCG	NON-FERROUS	★★★	276.168.52H	57
170	30	24	2,6	1,6	20°	10° ATB	WOOD	★★★★	291.170.24M	26
170	30	40	2,6	1,6	15°	15° ATB	WOOD	★★★★	292.170.40M	30
180	20	4	2,4	1,8	12°	TCG	MULTI-MATERIALS	★★★	236.180.04H	13
180	20	24	2,6	1,6	20°	10° ATB	WOOD	★★★★	291.180.24H	26
180	20	36	4,3-5,5	3,2	10°	CO+FLAT	WOOD	★★★★★	Y288.180.36H	51
180	20	40	2,6	1,6	15°	15° ATB	WOOD	★★★★	292.180.40H	30
180	20	40	2,8	2,2	-6° Neg.	TCG	NON-FERROUS	★★★★	296.180.40H	56
180	30	12	2,6	1,6	20°	10° ATB	WOOD	★★★★	290.180.12M	22
180	30	18	3,0	2,0	15°	FLAT	WOOD	★★★★	240.030.07M	67
180	30	18	4,0	3,0	15°	FLAT	WOOD	★★★★	240.040.07M	67
180	30	18	5,0	3,0	15°	FLAT	WOOD	★★★★	240.050.07M	67
180	30	18	6,0	3,0	15°	FLAT	WOOD	★★★★	240.060.07M	67
180	30	24	2,6	1,6	20°	10° ATB	WOOD	★★★★	291.180.24M	26
180	30	36	4,5-5,5	3,2	10°	CO+FLAT	WOOD	★★★★★	288.180.36M	51
180	30	40	2,6	1,6	15°	15° ATB	WOOD	★★★★	292.180.40M	30
180	30	56	3,2	2,2	5°	15° ATB	WOOD	★★★★	285.056.07M	30
180	35	18	3,0	2,0	15°	FLAT	WOOD	★★★★	240.030.07R	67
180	35	18	4,0	3,0	15°	FLAT	WOOD	★★★★	240.040.07R	67

D mm	B mm	Z	K mm	P mm	α	β	MATERIALS APPLICATION	PERFORMANCE	ORDER NO.	PAGE
180	35	18	5,0	3,0	15°	FLAT	WOOD	★★★★	240.050.07R	67
180	35	18	6,0	3,0	15°	FLAT	WOOD	★★★★	240.060.07R	67
180	40	21+3	2,5	1,8	18°	FLAT	WOOD	★★★★	280.021.07S	16
180	45	36	4,3-5,5	3,2	8°	CO+5° ATB	WOOD	★★★★★	288.180.36Q2	51
180	45	36	4,7-6,0	3,5	10°	CO+FLAT	WOOD	★★★★★	288.180.36Q	51
180	50	44	4,3-5,5	3,2	10°	CO+FLAT	WOOD	★★★★★	288.180.44T	51
180	55	36	5,0-6,2	3,5	10°	CO+FLAT	WOOD	★★★★★	288.180.360	51
184	16	24	2,6	1,6	20°	10° ATB	WOOD	★★★★	291.184.24E	26
184	16	40	2,6	1,6	15°	15° ATB	WOOD	★★★★	292.184.40E	30
184	30	24	2,6	1,6	20°	10° ATB	WOOD	★★★★	291.184.24M	26
184	30	24	1,7	1,1	20°	10° ATB + 8° Shear	WOOD	★★★	271.184.24M	27
184	30	40	2,6	1,6	15°	15° ATB	WOOD	★★★★	292.184.40M	30
184	30	40	1,7	1,1	18°	10° ATB + 8° Shear	WOOD	★★★	272.184.40M	31
184	15,87	48	2,0	1,6	0°	TCG	METAL & STEEL	★★★★	226.548.07	62
184	15,87	48	2,0	1,6	0°	8° FWF	METAL & STEEL	★★★★	226.048.07	61
184	20 (+16+15,87)	24	1,7	1,1	20°	10° ATB + 8° Shear	WOOD	★★★	271.184.24H	27
184	20 (+16+15,87)	40	1,7	1,1	18°	10° ATB + 8° Shear	WOOD	★★★	272.184.40H	31
184	20 (+16+15,87)	48	1,8	1,2	-6° Neg.	TCG	NON-FERROUS	★★★	276.184.48H	57
184	30 (+16+20)	64	2,0	1,6	0°	8° FWF	METAL & STEEL	★★★★	226.184.64M	60
190	16	24	2,6	1,6	20°	10° ATB	WOOD	★★★★	291.190.24E	26
190	20	12	2,6	1,6	20°	10° ATB	WOOD	★★★★	290.190.12H	22
190	20	24	2,6	1,6	20°	10° ATB	WOOD	★★★★	291.190.24H	26
190	30	4	2,4	1,8	12°	TCG	MULTI-MATERIALS	★★★	236.190.04M	13
190	30	12	2,4	1,8	12°	TCG	MULTI-MATERIALS	★★★	236.190.12M	13
190	30	24	2,3	1,2	5°	5° ATB	WOOD & NAILS	★★★★★	286.790.24M	11
190	30	24	2,6	1,6	20°	10° ATB	WOOD	★★★★	291.190.24M	26
190	30	24	2,5	2,0	10°	HR	MULTI-MATERIALS	★★★★★	235.190.24M	53
190	30	24	2,2	1,4	20°	10° ATB	WOOD	★★	K19024M	14
190	30	24	2,2	1,4	20°	10° ATB	WOOD	★★	K19024M-X10	14
190	30	30	2,6	2,2	5°	TCG	NON-FERROUS	★★★★	284.190.30M	54
190	30	40	2,6	1,6	15°	15° ATB	WOOD	★★★★	292.190.40M	30
190	30	40	2,8	2,2	-6° Neg.	TCG	NON-FERROUS	★★★★	296.190.40M	56
190	30	40	2,0	1,6	0°	8° FWF	METAL & STEEL	★★★★	226.040.07M	61
190	30	48	1,8	1,4	0°	TCG	METAL & STEEL	★★★★	226.548.07M	62
190	30	54	2,6	1,8	4°	TCG	WOOD	★★★★★	281.790.54M	46
190	30	64	2,6	1,6	15°	15° ATB	WOOD	★★★★	292.190.64M	36
190	30	64	2,8	2,2	-6° Neg.	TCG	NON-FERROUS	★★★★	296.190.64M	56
190	30 (+20)	64	2,0	1,6	0°	8° FWF	METAL & STEEL	★★★★	226.190.64M	60
190	20 (+16)	40	2,6	1,6	15°	15° ATB	WOOD	★★★★	292.190.40H	30
190	20 (FESTOOL® FF)	32	2,6	1,8	10°	10° ATB	WOOD	★★★★	291.190.32FF	26
190	20 (FESTOOL® FF)	48	2,4	1,8	10°	15° ATB	WOOD	★★★★	292.190.48FF	30
190	20 (FESTOOL® FF)	48	2,4	1,8	8°	15° ATB	WOOD	★★★★★	285.790.48FF	32
190	20 (FESTOOL® FF)	54	2,6	1,8	4°	TCG	WOOD	★★★★★	281.790.54FF	42
190	20 (FESTOOL® FF)	64	2,8	2,2	-6° Neg.	TCG	NON-FERROUS	★★★★	296.190.64FF	56
190	30 (+20+16)	12	2,6	1,6	20°	10° ATB	WOOD	★★★★	290.190.12M	22
190	30 (+20+16)	24	1,7	1,1	20°	10° ATB + 8° Shear	WOOD	★★★	271.190.24M	27
190	30 (+20+16)	42	1,7	1,1	18°	10° ATB + 8° Shear	WOOD	★★★	272.190.42M	31
190	30 (+20+16)	64	1,7	1,1	15°	10° ATB + 8° Shear	WOOD	★★★	273.190.64M	37
190	30 (+20+16)	64	1,8	1,2	-6° Neg.	TCG	NON-FERROUS	★★★	276.190.64M	57
200	20	36	4,4-5,3	3,2	10°	CO+FLAT	WOOD	★★★★★	288.200.36H	51
200	30	24	2,8	1,8	20°	10° ATB	WOOD	★★★★	290.200.24M	22
200	30	36	2,8	1,8	15°	15° ATB	WOOD	★★★★	291.200.36M	26
200	30	36	3,2	2,2	15°	10° ATB	WOOD	★★★★	285.036.08M	26
200	30	36	1,8	1,2	15°	10° ATB + 8° Shear	WOOD	★★★	271.200.36M	27
200	30	48	2,8	1,8	15°	15° ATB	WOOD	★★★★	292.200.48M	30
200	30	48	3,2	2,2	15°	15° ATB	WOOD	★★★★	285.048.08M	30
200	30	48	1,8	1,2	15°	10° ATB + 8° Shear	WOOD	★★★	272.200.48M	31

Saw Blade Index

D mm	B mm	Z	K mm	P mm	α	β	MATERIALS APPLICATION	PERFORMANCE	ORDER NO.	PAGE
200	30	48	2,8	2,2	-6° Neg.	TCG	NON-FERROUS	★★★★	296.200.48M	56
200	30	64	3,2	2,2	5°	15° ATB	WOOD	★★★★	285.064.08M	36
200	30	64	3,2	2,2	10°	TCG	WOOD	★★★★	281.064.08M	47
200	32	0	1,8	-	-	Not Sharpened	METAL & STEEL	-	227.200P	59
200	32	160	1,8	-	-	BW	METAL & STEEL	-	227.200.160P	59
200	40	21+3	2,5	1,8	18°	FLAT	WOOD	★★★★	280.021.08S	16
200	45	36	4,7-6,0	3,5	10°	CO+FLAT	WOOD	★★★★★	288.200.36Q	51
200	45	36	4,3-5,5	3,2	10°	CO+FLAT	WOOD	★★★★★	Y288.200.36Q2	51
200	65	36	4,4-5,3	3,2	10°	CO+FLAT	WOOD	★★★★★	288.200.36J	51
203	30	12	-	-	-12° Neg.	FLAT+ATB	WOOD	★★★★★	230.312.08M	65
203	15,87	12	-	-	-12° Neg.	FLAT+ATB	WOOD	★★★★★	230.312.08	65
203	15,87	24	-	-	-12° Neg.	FLAT+ATB	WOOD	★★★★★	230.524.08	64
203	15,87	48	2,2	1,8	0°	8° FWF	METAL & STEEL	★★★★	226.048.08	61
210	25	36	2,8	1,8	15°	15° ATB	WOOD	★★★★	291.210.36L	26
210	25	48	2,8	1,8	15°	15° ATB	WOOD	★★★★	292.210.48L	30
210	30	12	2,4	1,8	12°	TCG	MULTI-MATERIALS	★★★	236.210.12M	13
210	30	24	2,8	1,8	20°	10° ATB	WOOD	★★★★	290.210.24M	22
210	30	36	2,8	1,8	15°	15° ATB	WOOD	★★★★	291.210.36M	26
210	30	48	2,8	1,8	15°	15° ATB	WOOD	★★★★	292.210.48M	30
210	30	48	2,8	2,2	-6° Neg.	TCG	NON-FERROUS	★★★★	296.210.48M	56
210	30	48	2,2	1,8	0°	8° FWF	METAL & STEEL	★★★★	226.048.08M	61
210	30	60	2,6	1,6	-3° Neg.	TCG	WOOD	★★★★★	281.810.60M	46
210	30	64	2,8	1,8	15°	15° ATB	WOOD	★★★★	292.210.64M	36
210	30	64	2,8	2,2	-6° Neg.	TCG	NON-FERROUS	★★★★	296.210.64M	56
210	30	64	2,2	1,8	0°	8° FWF	METAL & STEEL	★★★★	226.210.64M	60
210	30 (+25)	24	1,8	1,2	20°	10° ATB + 8° Shear	WOOD	★★★	271.210.24M	27
210	30 (+25)	36	1,8	1,2	15°	10° ATB + 8° Shear	WOOD	★★★	271.210.36M	27
210	30 (+25)	48	1,8	1,2	15°	10° ATB + 8° Shear	WOOD	★★★	272.210.48M	31
210	30 (+25)	64	1,8	1,2	-6° Neg.	TCG	NON-FERROUS	★★★	276.210.64M	57
215	50	42	4,3-5,5	3,2	8°	CO+FLAT	WOOD	★★★★★	288.215.42T	51
216	30	14	2,4	1,8	12°	TCG	MULTI-MATERIALS	★★★	236.216.14M	13
216	30	24	2,8	1,8	-5° Neg.	15° ATB	WOOD	★★★★	290.216.24M	22
216	30	24	2,4	1,6	-5° Neg.	15° ATB	WOOD	★★	K21624M	14
216	30	24	2,4	1,6	-5° Neg.	15° ATB	WOOD	★★	K21624M-X10	14
216	30	30	2,5	2,0	10°	HR	MULTI-MATERIALS	★★★★★	235.216.30M	53
216	30	36	1,8	1,2	-5° Neg.	10° ATB + 8° Shear	WOOD	★★★	271.216.36M	27
216	30	40	2,6	2,2	5°	TCG	NON-FERROUS	★★★★	284.216.40M	54
216	30	48	2,8	1,8	-5° Neg.	15° ATB	WOOD	★★★★	291.216.48M	26
216	30	48	2,3	1,6	-5° Neg.	15° ATB	WOOD	★★★★★	285.816.48M	28
216	30	48	1,8	1,2	-5° Neg.	10° ATB + 8° Shear	WOOD	★★★	272.216.48M	31
216	30	48	2,2	1,8	0°	8° FWF	METAL & STEEL	★★★★	226.047.09M	61
216	30	48	2,4	1,6	-5° Neg.	15° ATB	WOOD	★★	K21648M	14
216	30	48	2,4	1,6	-5° Neg.	15° ATB	WOOD	★★	K21648M-X10	14
216	30	56	1,8	1,4	0°	TCG	METAL & STEEL	★★★★	226.556.09M	62
216	30	60	2,3	1,6	-5° Neg.	15° ATB	WOOD	★★★★★	285.816.60M	32
216	30	64	2,8	1,8	-5° Neg.	15° ATB	WOOD	★★★★	292.216.64M	30
216	30	64	1,8	1,2	-5° Neg.	10° ATB + 8° Shear	WOOD	★★★	273.216.64M	37
216	30	64	2,6	1,6	-3° Neg.	TCG	WOOD	★★★★★	281.816.64M	46
216	30	64	2,3	1,6	0°	TCG	NON-FERROUS	★★★★★	297.816.64M	55
216	30	64	2,8	2,2	-6° Neg.	TCG	NON-FERROUS	★★★★	297.064.09M	56
216	30	64	2,2	1,6	-6° Neg.	TCG	NON-FERROUS	★★★	276.216.64M	57
216	30	64	2,2	1,8	0°	8° FWF	METAL & STEEL	★★★★	226.216.64M	60
216	30	80	2,8	1,8	-5° Neg.	15° ATB	WOOD	★★★★	292.216.80M	36
216	30	80	2,8	2,2	-6° Neg.	TCG	NON-FERROUS	★★★★	297.080.09M	56
220	30	24	2,8	1,8	20°	10° ATB	WOOD	★★★★	290.220.24M	22
220	30	36	2,8	1,8	15°	15° ATB	WOOD	★★★★	291.220.36M	26
220	30	42	3,2	2,2	-6° Neg.	HDF	WOOD	★★★★	287.043.09M	34

D mm	B mm	Z	K mm	P mm	α	β	MATERIALS APPLICATION	PERFORMANCE	ORDER NO.	PAGE
220	30	42	3,2	2,2	10°	HDF	WOOD	★★★★	287.042.09M	35
220	30	48	2,8	1,8	15°	15° ATB	WOOD	★★★★	292.220.48M	30
220	30	63	3,2	2,2	-3° Neg.	FFT	WOOD	★★★★★	281.063.09M	45
220	30	64	3,2	2,2	-5° Neg.	40° Hi-ATB	WOOD	★★★★★	283.064.09M	39
220	30	64	3,2	2,2	10°	TCG	WOOD	★★★★	281.064.09M	47
225	30	36	2,8	1,8	20°	15° ATB	WOOD	★★★★	291.225.36M	26
225	30	48	2,8	1,8	10°	15° ATB	WOOD	★★★★	292.225.48M	30
225	30	64	2,6	1,8	4°	TCG	WOOD	★★★★	281.225.64M	47
225	30	64	2,8	2,2	-6° Neg.	TCG	NON-FERROUS	★★★★	296.225.64M	56
225	32	0	1,9	-	-	Not Sharpened	METAL & STEEL	-	227.225P	59
225	32	180	1,9	-	-	BW	METAL & STEEL	-	227.225.180P	59
230	30	4	2,4	1,8	12°	TCG	MULTI-MATERIALS	★★★	236.230.04M	13
230	30	24	2,8	1,8	20°	10° ATB	WOOD	★★★★	290.230.24M	22
230	30	36	2,8	1,8	15°	15° ATB	WOOD	★★★★	291.230.36M	26
230	30	48	2,8	1,8	15°	15° ATB	WOOD	★★★★	292.230.48M	30
230	30	48	2,8	2,2	-6° Neg.	TCG	NON-FERROUS	★★★★	296.230.48M	56
230	30	64	2,8	1,8	15°	15° ATB	WOOD	★★★★	292.230.64M	36
230	22,2	-	-	-	-	-	MULTI-MATERIALS	-	286.230.01	12
235	25	24	2,8	1,8	20°	10° ATB	WOOD	★★★★	290.235.24L	22
235	25	36	2,8	1,8	15°	15° ATB	WOOD	★★★★	291.235.36L	26
235	25	36	1,7	1,2	20°	1 FLAT+2/15° ATB	WOOD	★★★	271.235.36L	27
235	25	48	2,8	1,8	15°	15° ATB	WOOD	★★★★	292.235.48L	30
235	30	36	2,8	1,8	15°	15° ATB	WOOD	★★★★	291.235.36M	26
235	30	48	2,8	1,8	15°	15° ATB	WOOD	★★★★	292.235.48M	30
235	30	48	2,8	2,2	-6° Neg.	TCG	NON-FERROUS	★★★★	296.235.48M	56
235	30	48	2,2	1,8	0°	8° FWF	METAL & STEEL	★★★★	226.048.09M	61
235	30 (+25)	24	2,8	1,8	20°	10° ATB	WOOD	★★★★	290.235.24M	22
235	30 (+25)	36	2,4	1,6	18°	10° ATB + 8° Shear	WOOD	★★★	271.235.36M	27
235	30 (+25)	48	2,4	1,6	18°	10° ATB + 8° Shear	WOOD	★★★	272.235.48M	31
240	30	24	2,8	1,8	20°	10° ATB	WOOD	★★★★	290.240.24M	22
240	30	36	2,8	1,8	15°	15° ATB	WOOD	★★★★	291.240.36M	26
240	30	48	2,8	1,8	15°	15° ATB	WOOD	★★★★	292.240.48M	30
250	20	40	3,2	2,2	15°	10° ATB	WOOD	★★★★★	285.040.10H	25
250	30	16	2,8	1,8	15°	5° ATB	WOOD	★★★★	286.016.10M	10
250	30	16	2,4	1,8	12°	TCG	MULTI-MATERIALS	★★★	236.250.16M	13
250	30	24	3,2	2,2	10°	FLAT	WOOD	★★★★★	285.624.10M	20
250	30	24	2,8	1,8	20°	10° ATB	WOOD	★★★★	290.250.24M	22
250	30	24	2,4	1,6	20°	10° ATB + 8° Shear	WOOD	★★★	271.250.24M	23
250	30	36	2,5	2,0	10°	HR	MULTI-MATERIALS	★★★★★	235.250.36M	53
250	30	40	3,2	2,2	5°	10° ATB	WOOD	★★★★★	285.640.10M	24
250	30	40	3,2	2,2	5°	10° ATB	WOOD	★★★★★	285.040.10M	25
250	30	40	2,6	1,8	15°	10° ATB	WOOD	★★	K25040M	14
250	30	40	2,6	1,8	15°	10° ATB	WOOD	★★	K25040M-X05	14
250	30	42	2,4	1,6	18°	10° ATB + 8° Shear	WOOD	★★★	271.250.42M	27
250	30	48	3,2	2,2	15°	10° ATB	WOOD	★★★★★	285.048.10M	25
250	30	48	3,2	2,2	-6° Neg.	HDF	WOOD	★★★★	287.049.10M	34
250	30	48	3,2	2,2	10°	HDF	WOOD	★★★★	287.048.10M	35
250	30	48	3,2	2,2	10°	TCG	WOOD	★★★★★	237.048.10M	52
250	30	50	2,4	1,6	15°	FLAT + 10° ATB + 8° Shear	WOOD	★★★	272.250.50M	31
250	30	60	3,2	2,2	10°	15° ATB	WOOD	★★★★★	285.660.10M	28
250	30	60	3,2	2,2	10°	15° ATB	WOOD	★★★★★	285.060.10M	29
250	30	60	2,4	1,6	15°	10° ATB + 8° Shear	WOOD	★★★	272.250.60M	31
250	30	60	3,2	2,2	10°	TCG	WOOD	★★★★★	281.060.10M	43
250	30	60	3,2	2,2	-3° Neg.	FFT	WOOD	★★★★★	281.061.10M	45
250	30	72	2,2	1,8	0°	10° FWF	METAL & STEEL	★★★★	226.572.10M	62
250	30	72	3,2	2,5	0°	MTCG	MULTI-MATERIALS	★★★★★	223.072.10M	63
250	30	78	3,2	2,2	10°	FFT	WOOD	★★★★★	295.078.10M	44

Saw Blade Index

D mm	B mm	Z	K mm	P mm	α	β	MATERIALS APPLICATION	PERFORMANCE	ORDER NO.	PAGE
250	30	80	3,2	2,2	5°	15° ATB	WOOD	★★★★★	285.680.10M	32
250	30	80	3,2	2,2	5°	15° ATB	WOOD	★★★★★	285.080.10M	33
250	30	80	2,4	1,6	12°	10° ATB + 8° Shear	WOOD	★★★	273.250.80M	37
250	30	80	3,2	2,2	-2° Neg.	38° Hi-ATB	WOOD	★★★★★	283.680.10M	38
250	30	80	3,2	2,2	-2° Neg.	40° Hi-ATB	WOOD	★★★★★	283.080.10M	39
250	30	80	3,0	2,5	10°	20° ATB	WOOD	★★★★★	285.580.10M	40
250	30	80	3,2	2,2	15°	1° FLAT + 4° ATB	WOOD	★★★★★	274.080.10M	41
250	30	80	3,2	2,2	5°	TCG	WOOD	★★★★★	281.680.10M	42
250	30	80	3,2	2,2	10°	TCG	WOOD	★★★★★	281.080.10M	43
250	30	80	3,2	2,2	-3° Neg.	TCG	WOOD	★★★★★	281.681.10M	46
250	30	80	3,2	2,5	-6° Neg.	TCG	NON-FERROUS	★★★★★	297.080.10M	55
250	30	80	2,6	1,8	-6° Neg.	TCG	NON-FERROUS	★★★	276.250.80M	57
250	30	80	2,8	2,2	-3° Neg.	MATB	MULTI-MATERIALS	★★★★★	222.080.10M	63
250	30	20+4	3,2	2,2	18°	10° ATB	WOOD	★★★★	279.020.10M	18
250	32	0	2,0	-	-	Not Sharpened	METAL & STEEL	-	227.250P	59
250	32	80	3,2	2,5	6°	TCG	NON-FERROUS	★★★★★	284.080.10P	54
250	32	80	3,2	2,5	-6° Neg.	TCG	NON-FERROUS	★★★★★	297.080.10P	55
250	32	128	2,0	-	-	C/HZ	METAL & STEEL	-	227.250.128P	58
250	32	160	2,0	-	-	BW	METAL & STEEL	-	227.250.160P	59
250	32	200	2,0	-	-	BW	METAL & STEEL	-	227.250.200P	59
250	32	200	2,0	-	-	BW	METAL & STEEL	-	227.250.700P	59
250	35	40	3,2	2,2	15°	10° ATB	WOOD	★★★★★	285.040.10R	25
250	35	60	3,2	2,2	10°	15° ATB	WOOD	★★★★★	285.060.10R	29
250	35	80	3,2	2,2	5°	15° ATB	WOOD	★★★★★	285.080.10R	33
250	70	20+4	2,7	1,8	18°	10° ATB	WOOD	★★★★	280.020.10V	16
250	70	20+4	3,2	2,2	18°	10° ATB	WOOD	★★★★	279.020.10V	18
250	80	20+4	2,7	1,8	18°	10° ATB	WOOD	★★★★	280.020.10W	16
250	80	20+4	3,2	2,2	18°	10° ATB	WOOD	★★★★	279.020.10W	18
250	25,4 (+20)	20	2,0	1,4	2°	8° ATB	MULTI-MATERIALS	★★★★	298.250.20	70
250	25,4 (+20)	40	2,0	1,4	2°	8° ATB	MULTI-MATERIALS	★★★★	298.250.40	70
254	30	48	2,4	1,8	-5° Neg.	15° ATB	WOOD	★★★★★	294.048.10M	25
254	30	60	2,4	1,8	-5° Neg.	15° ATB	WOOD	★★★★★	294.060.10M	29
254	30	60	2,2	1,8	0°	8° FWF	METAL & STEEL	★★★★	226.060.10M	60
254	30	80	3,2	2,5	-6° Neg.	TCG	NON-FERROUS	★★★★★	297.081.10M	55
254	15,87	72	2,2	1,8	0°	10° FWF	METAL & STEEL	★★★★	226.572.10	62
254	15,87	48	2,2	1,8	0°	8° FWF	METAL & STEEL	★★★★	226.048.10	61
254	15,87	60	2,2	1,8	0°	8° FWF	METAL & STEEL	★★★★	226.060.10	60
260	30	28	2,8	1,8	20°	10° ATB	WOOD	★★★★	290.260.28M	22
260	30	48	2,8	1,8	15°	10° ATB	WOOD	★★★★	285.048.11M	26
260	30	60	2,5	1,8	-5° Neg.	10° ATB	WOOD	★★★★★	285.860.11M	28
260	30	60	2,8	1,8	10°	15° ATB	WOOD	★★★★	285.060.11M	30
260	30	60	2,5	1,8	-5° Neg.	15° ATB	WOOD	★★★★	294.060.11M	30
260	30	64	2,5	1,8	-3° Neg.	TCG	WOOD	★★★★	281.065.11M	47
260	30	80	2,5	1,8	-5° Neg.	15° ATB	WOOD	★★★★	294.080.11M	36
260	30	80	3,2	2,5	-6° Neg.	TCG	NON-FERROUS	★★★★★	297.080.11M	55
270	30	28	2,8	1,8	20°	10° ATB	WOOD	★★★★	290.270.28M	22
270	30	42	2,8	1,8	15°	10° ATB	WOOD	★★★★	291.270.42M	26
275	20	42	3,2	2,2	15°	10° ATB	WOOD	★★★★★	285.042.11H	25
275	32	0	2,5	-	-	Not Sharpened	METAL & STEEL	-	227.275P	59
275	32	140	2,5	-	-	C/HZ	METAL & STEEL	-	227.275.140P	58
275	32	220	2,5	-	-	BW	METAL & STEEL	-	227.275.220P	59
275	32	220	2,0	-	-	BW	METAL & STEEL	-	227.275.722P	59
275	32	220	2,5	-	-	BW	METAL & STEEL	-	227.275.720P	59
280	30	64	2,8	1,8	10°	15° ATB	WOOD	★★★★★	295.064.11M	29
280	30	64	3,2	2,5	-6° Neg.	TCG	NON-FERROUS	★★★★★	297.064.11M	55
300	20	48	3,2	2,2	15°	10° ATB	WOOD	★★★★★	285.048.12H	25
300	30	20	2,8	1,8	15°	5° ATB	WOOD	★★★★	286.020.12M	10

D mm	B mm	Z	K mm	P mm	α	β	MATERIALS APPLICATION	PERFORMANCE	ORDER NO.	PAGE
300	30	20	2,4	1,8	12°	TCG	MULTI-MATERIALS	★★★	236.300.20M	13
300	30	24	3,2	2,2	20°	10° ATB	WOOD	★★★★★	293.024.12M	21
300	30	24	2,6	1,8	22°	10° ATB + 8° Shear	WOOD	★★★★	271.300.24M	23
300	30	28	3,2	2,2	18°	10° ATB	WOOD	★★★★★	278.028.12M	19
300	30	36	3,2	2,2	15°	10° ATB	WOOD	★★★★★	285.036.12M	25
300	30	44	2,5	2,0	10°	HR	MULTI-MATERIALS	★★★★★	235.300.44M	53
300	30	48	3,2	2,2	15°	10° ATB	WOOD	★★★★★	286.048.12M	10
300	30	48	3,2	2,2	5°	10° ATB	WOOD	★★★★★	285.648.12M	24
300	30	48	3,2	2,2	5°	10° ATB	WOOD	★★★★★	285.048.12M	25
300	30	48	2,6	1,8	18°	10° ATB + 8° Shear	WOOD	★★★★	271.300.48M	27
300	30	60	3,2	2,2	15°	10° ATB	WOOD	★★★★★	285.060.12M	29
300	30	60	4,4	3,2	16°	TCG	WOOD	★★★★★	282.060.12M	48
300	30	60	4,4	3,2	15°	TCG	WOOD	★★★★★	282.300.60M	49
300	30	60	3,2	2,2	10°	TCG	WOOD	★★★★★	237.060.12M	52
300	30	72	3,2	2,2	10°	15° ATB	WOOD	★★★★★	285.672.12M	28
300	30	72	3,2	2,2	10°	15° ATB	WOOD	★★★★★	285.072.12M	29
300	30	72	2,6	1,8	15°	10° ATB + 8° Shear	WOOD	★★★★	272.300.72M	31
300	30	72	3,2	2,2	10°	TCG	WOOD	★★★★★	281.672.12M	42
300	30	72	3,2	2,2	10°	TCG	WOOD	★★★★★	281.072.12M	43
300	30	72	3,2	2,2	-3° Neg.	FFT	WOOD	★★★★★	281.073.12M	45
300	30	80	2,2	1,8	0°	10° FWF	METAL & STEEL	★★★★★	226.580.12M	62
300	30	84	3,2	2,5	0°	MTCG	MULTI-MATERIALS	★★★★★	223.084.12M	63
300	30	96	3,2	2,2	5°	15° ATB	WOOD	★★★★★	285.696.12M	32
300	30	96	3,2	2,2	5°	15° ATB	WOOD	★★★★★	285.096.12M	33
300	30	96	2,6	1,8	12°	10° ATB + 8° Shear	WOOD	★★★★	273.300.96M	37
300	30	96	3,2	2,2	2°	38° Hi-ATB	WOOD	★★★★★	283.696.12M	38
300	30	96	3,2	2,2	2°	40° Hi-ATB	WOOD	★★★★★	283.096.12M	39
300	30	96	3,0	2,5	10°	20° ATB	WOOD	★★★★★	285.596.12M	40
300	30	96	3,2	2,2	5°	TCG	WOOD	★★★★★	281.696.12M	42
300	30	96	3,2	2,2	10°	TCG	WOOD	★★★★★	281.096.12M	43
300	30	96	3,2	2,2	10°	FFT	WOOD	★★★★★	295.096.12M	44
300	30	96	3,2	2,2	-3° Neg.	TCG	WOOD	★★★★★	281.697.12M	46
300	30	96	3,2	2,2	15°	TCG	WOOD	★★★★★	237.096.12M	52
300	30	96	3,2	2,5	-6° Neg.	TCG	NON-FERROUS	★★★★★	297.096.12M	55
300	30	96	2,8	2,0	-6° Neg.	TCG	NON-FERROUS	★★★★	276.300.96M	57
300	30	96	2,8	2,2	-3° Neg.	MATB	MULTI-MATERIALS	★★★★★	222.096.12M	63
300	30	100	3,2	2,2	15°	1° FLAT + 4° ATB	WOOD	★★★★★	274.100.12M	41
300	30	24+4	3,2	2,2	18°	10° ATB	WOOD	★★★★★	279.024.12M	18
300	30	24+4	4,0	2,8	18°	10° ATB	WOOD	★★★★★	277.024.12M	17
300	32	0	2,5	-	-	Not Sharpened	METAL & STEEL	-	227.300P	59
300	32	96	3,2	2,5	6°	TCG	NON-FERROUS	★★★★★	284.096.12P	54
300	32	96	3,2	2,5	-6° Neg.	TCG	NON-FERROUS	★★★★★	297.096.12P	55
300	32	160	2,5	-	-	C/HZ	METAL & STEEL	-	227.300.160P	58
300	32	220	2,5	-	-	BW	METAL & STEEL	-	227.300.220P	59
300	32	220	2,0	-	-	BW	METAL & STEEL	-	227.300.722P	59
300	32	220	2,5	-	-	BW	METAL & STEEL	-	227.300.720P	59
300	35	24	3,2	2,2	20°	10° ATB	WOOD	★★★★★	293.024.12R	21
300	35	48	3,2	2,2	15°	10° ATB	WOOD	★★★★★	285.048.12R	25
300	35	72	3,2	2,2	10°	15° ATB	WOOD	★★★★★	285.072.12R	29
300	35	96	3,2	2,2	5°	15° ATB	WOOD	★★★★★	285.096.12R	33
300	50	48	4,3-5,5	3,2	10°	CO+FLAT	WOOD	★★★★★	288.300.48T	51
300	60	24+4	3,2	2,2	18°	10° ATB	WOOD	★★★★★	279.024.12U	18
300	65	72	4,3-5,5	3,2	10°	CO+FLAT	WOOD	★★★★★	288.300.72J	51
300	70	28	3,2	2,2	18°	10° ATB	WOOD	★★★★★	278.028.12V	19
300	70	24+4	2,7	1,8	18°	10° ATB	WOOD	★★★★★	280.024.12V	16
300	70	24+4	3,2	2,2	18°	10° ATB	WOOD	★★★★★	279.024.12V	18
300	70	24+4	4,0	2,8	18°	10° ATB	WOOD	★★★★★	277.024.12V	17

Saw Blade Index

D mm	B mm	Z	K mm	P mm	α	β	MATERIALS APPLICATION	PERFORMANCE	ORDER NO.	PAGE
300	75	60	4,4	3,2	16°	TCG	WOOD	★★★★	282.060.12X	48
300	80	60	4,4	3,2	16°	TCG	WOOD	★★★★	282.060.12W	48
300	80	60	4,4	3,2	16°	TCG	WOOD	★★★★★	282.300.60W	49
300	80	24+4	2,7	1,8	18°	10° ATB	WOOD	★★★★	280.024.12W	16
300	80	24+4	3,2	2,2	18°	10° ATB	WOOD	★★★★	279.024.12W	18
300	80	24+4	4,0	2,8	18°	10° ATB	WOOD	★★★★	277.024.12W	17
303	30	60	3,2	2,2	-6° Neg.	HDF	WOOD	★★★★	287.061.12M	34
303	30	60	3,2	2,2	10°	HDF	WOOD	★★★★	287.060.12M	35
305	30	28	2,8	1,8	20°	10° ATB	WOOD	★★★★★	293.028.22M	21
305	30	48	2,6	1,8	-5° Neg.	10° ATB	WOOD	★★★	271.305.48M	27
305	30	54	2,8	1,8	-5° Neg.	15° ATB	WOOD	★★★★★	294.054.22M	25
305	30	72	3,2	2,2	10°	15° ATB	WOOD	★★★★★	285.072.22M	29
305	30	72	3,2	2,2	-5° Neg.	15° ATB	WOOD	★★★★★	294.072.22M	29
305	30	72	2,6	1,8	-5° Neg.	10° ATB	WOOD	★★★	272.305.72M	31
305	30	80	2,2	1,8	0°	8° FWF	METAL & STEEL	★★★★	226.080.12M	60
305	30	96	3,2	2,5	-6° Neg.	TCG	NON-FERROUS	★★★★★	297.096.13M	55
305	30	96	2,8	2,0	-6° Neg.	TCG	NON-FERROUS	★★★	276.305.96M	57
305	25,4	80	2,2	1,8	0°	10° FWF	METAL & STEEL	★★★★	226.580.12	62
305	25,4	60	2,2	1,8	0°	8° FWF	METAL & STEEL	★★★★	226.060.12	61
305	25,4	80	2,2	1,8	0°	8° FWF	METAL & STEEL	★★★★	226.080.12	60
315	30	24	3,2	2,2	15°	5° ATB	WOOD	★★★★	286.024.13M	10
315	30	28	3,2	2,2	20°	10° ATB	WOOD	★★★★★	293.028.12M	21
315	30	36	3,2	2,2	15°	5° ATB	WOOD	★★★★★	285.036.13M	21
315	30	54	3,2	2,2	15°	10° ATB	WOOD	★★★★★	294.054.12M	25
315	30	54	2,6	1,8	-5° Neg.	10° ATB	WOOD	★★★	271.315.54M	27
315	30	72	3,2	2,2	15°	10° ATB	WOOD	★★★★★	285.072.13M	29
315	30	96	3,2	2,5	-6° Neg.	TCG	NON-FERROUS	★★★★★	297.096.23M	55
315	32	0	2,5	-	-	Not Sharpened	METAL & STEEL	-	227.315P	59
315	32	160	2,5	-	-	C/HZ	METAL & STEEL	-	227.315.160P	58
315	32	240	2,5	-	-	BW	METAL & STEEL	-	227.315.240P	59
315	32	240	2,5	-	-	BW	METAL & STEEL	-	227.315.740P	59
320	65	60	4,4	3,2	16°	TCG	WOOD	★★★★	Y282.060.13J	48
320	65	60	4,4	3,2	15°	TCG	WOOD	★★★★★	282.320.60J	49
320	65	72	4,4	3,2	16°	TCG	WOOD	★★★★	282.072.13J	48
320	65	72	4,4	3,2	15°	TCG	WOOD	★★★★★	282.320.72J	49
330	30	96	3,6	3,0	-6° Neg.	TCG	NON-FERROUS	★★★★★	297.096.33M	55
330	32	96	3,6	3,0	-6° Neg.	TCG	NON-FERROUS	★★★★★	297.096.33P	55
350	30	24	3,2	2,2	15°	5° ATB	WOOD	★★★★★	286.024.14M	10
350	30	28	3,5	2,5	20°	10° ATB	WOOD	★★★★★	293.028.14M	21
350	30	36	3,5	2,5	18°	10° ATB	WOOD	★★★★★	278.036.14M	19
350	30	54	3,5	2,5	5°	10° ATB	WOOD	★★★★★	285.654.14M	24
350	30	54	3,5	2,5	5°	10° ATB	WOOD	★★★★★	285.054.14M	25
350	30	54	4,4	3,2	16°	TCG	WOOD	★★★★	282.054.14M	48
350	30	72	3,5	2,5	15°	10° ATB	WOOD	★★★★★	285.072.14M	29
350	30	72	4,4	3,2	16°	TCG	WOOD	★★★★	282.072.14M	48
350	30	72	4,4	3,2	15°	TCG	WOOD	★★★★★	282.350.72M	49
350	30	72	3,5	2,4	15°	TCG	WOOD	★★★★★	237.072.14M	52
350	30	84	3,5	2,5	10°	15° ATB	WOOD	★★★★★	285.684.14M	28
350	30	84	3,5	2,5	10°	15° ATB	WOOD	★★★★★	285.084.14M	29
350	30	84	3,5	2,5	10°	TCG	WOOD	★★★★★	281.684.14M	42
350	30	84	3,5	2,5	10°	TCG	WOOD	★★★★★	281.084.14M	43
350	30	108	3,5	2,5	5°	15° ATB	WOOD	★★★★★	285.708.14M	32
350	30	108	3,5	2,5	5°	15° ATB	WOOD	★★★★★	285.108.14M	33
350	30	108	3,5	2,5	5°	40° Hi-ATB	WOOD	★★★★★	283.108.14M	39
350	30	108	3,5	2,5	5°	TCG	WOOD	★★★★★	281.708.14M	42
350	30	108	3,5	2,5	10°	TCG	WOOD	★★★★★	281.108.14M	43
350	30	108	3,5	2,5	10°	FFT	WOOD	★★★★★	295.108.14M	44

Saw Blade Index

D mm	B mm	Z	K mm	P mm	α	β	MATERIALS APPLICATION	PERFORMANCE	ORDER NO.	PAGE
350	30	108	3,5	2,5	10°	TCG	WOOD	★★★★	281.108.14M	48
350	30	108	3,6	3,0	-6° Neg.	TCG	NON-FERROUS	★★★★★	297.108.14M	55
350	30	24+6	4,2	2,8	18°	10° ATB	WOOD	★★★★	277.024.14M	17
350	30	28+4	3,5	2,5	18°	10° ATB	WOOD	★★★★	279.028.14M	18
350	32	0	2,5	-	-	Not Sharpened	METAL & STEEL	-	227.350P	59
350	32	84	3,6	3,0	6°	TCG	NON-FERROUS	★★★★★	284.092.14P	54
350	32	108	3,6	3,0	6°	TCG	NON-FERROUS	★★★★★	284.108.14P	54
350	32	108	3,6	3,0	-6° Neg.	TCG	NON-FERROUS	★★★★★	297.108.14P	55
350	32	180	2,5	-	-	C/HZ	METAL & STEEL	-	227.350.180P	58
350	32	280	2,5	-	-	BW	METAL & STEEL	-	227.350.280P	59
350	32	280	2,5	-	-	BW	METAL & STEEL	-	227.350.780P	59
350	35	28	3,5	2,5	20°	10° ATB	WOOD	★★★★★	293.028.14R	21
350	35	54	3,5	2,5	15°	10° ATB	WOOD	★★★★★	285.054.14R	25
350	35	84	3,5	2,5	10°	15° ATB	WOOD	★★★★★	285.084.14R	29
350	35	108	3,5	2,5	5°	15° ATB	WOOD	★★★★★	285.108.14R	33
350	50	72	4,4	3,2	16°	TCG	WOOD	★★★★	282.072.14T	48
350	60	72	4,4	3,2	16°	TCG	WOOD	★★★★	Y282.072.14U	48
350	60	72	4,4	3,2	15°	TCG	WOOD	★★★★★	282.350.72U	49
350	60	28+4	3,5	2,5	18°	10° ATB	WOOD	★★★★	279.028.14U	18
350	70	36	3,5	2,5	18°	10° ATB	WOOD	★★★★★	278.036.14V	19
350	70	24+6	4,2	2,8	18°	10° ATB	WOOD	★★★★	277.024.14V	17
350	70	28+4	3,5	2,5	18°	10° ATB	WOOD	★★★★	279.028.14V	18
350	75	54	4,4	3,2	16°	TCG	WOOD	★★★★	282.054.14X	48
350	75	72	4,4	3,2	16°	TCG	WOOD	★★★★	282.072.14X	48
350	75	72	4,4	3,2	15°	TCG	WOOD	★★★★★	282.350.72X	49
350	80	54	4,4	3,2	16°	TCG	WOOD	★★★★	282.054.14W	48
350	80	72	4,4	3,2	16°	TCG	WOOD	★★★★	282.072.14W	48
350	80	72	4,4	3,2	16°	TCG	WOOD	★★★★★	282.350.72W	49
350	80	28+4	3,5	2,5	18°	10° ATB	WOOD	★★★★	279.028.14W	18
355	30	72	4,4	3,2	16°	TCG	WOOD	★★★★	S282.03556	48
355	30	90	2,2	1,8	0°	8° FWF	METAL & STEEL	★★★★	226.090.14M	60
355	30	90	2,2	1,8	0°	10° FWF	METAL & STEEL	★★★★	226.590.14M	62
355	65	72	4,4	3,2	16°	TCG	WOOD	★★★★	282.072.14J2	48
355	65	72	4,4	3,2	16°	TCG	WOOD	★★★★★	282.355.72J	49
355	80	72	4,4	3,2	10°	TCG	WOOD	★★★★	282.072.14W2	48
355	25,4	72	2,2	1,8	0°	8° FWF	METAL & STEEL	★★★★	226.072.14	61
355	25,4	90	2,2	1,8	0°	8° FWF	METAL & STEEL	★★★★	226.090.14	60
355	25,4	90	2,2	1,8	0°	10° FWF	METAL & STEEL	★★★★	226.590.14	62
380	60	72	4,4	3,2	15°	TCG	WOOD	★★★★	282.072.15U2	48
380	60	72	4,8	3,5	16°	TCG	WOOD	★★★★	282.072.15U	48
380	60	72	4,4	3,2	15°	TCG	WOOD	★★★★★	282.380.72U2	49
380	60	72	4,8	3,5	15°	TCG	WOOD	★★★★★	282.380.72U	49
380	80	72	4,4	3,2	16°	TCG	WOOD	★★★★	282.072.15W	48
380	80	72	4,4	3,2	16°	TCG	WOOD	★★★★★	282.380.72W	49
400	30	28	3,2	2,2	15°	5° ATB	WOOD	★★★★★	286.028.16M	10
400	30	36	3,5	2,5	20°	10° ATB	WOOD	★★★★★	285.036.16M	21
400	30	48	3,5	2,5	20°	10° ATB	WOOD	★★★★★	285.048.16M	25
400	30	60	3,5	2,5	10°	15° ATB	WOOD	★★★★★	285.660.16M	24
400	30	60	3,5	2,5	10°	15° ATB	WOOD	★★★★★	285.060.16M	25
400	30	60	4,4	3,2	16°	TCG	WOOD	★★★★	282.060.16M	48
400	30	72	4,4	3,2	16°	TCG	WOOD	★★★★	282.072.16M	48
400	30	72	4,4	3,2	15°	TCG	WOOD	★★★★★	282.400.72M	49
400	30	96	3,5	2,5	10°	15° ATB	WOOD	★★★★★	285.696.16M	28
400	30	96	3,5	2,5	10°	15° ATB	WOOD	★★★★★	285.096.16M	29
400	30	120	3,5	2,5	10°	15° ATB	WOOD	★★★★★	285.120.16M	33
400	30	120	4,0	3,2	-6° Neg.	TCG	NON-FERROUS	★★★★★	297.120.16M	55
400	30	28+6	4,0	2,8	18°	10° ATB	WOOD	★★★★	279.028.16M	18

Saw Blade Index

D mm	B mm	Z	K mm	P mm	α	β	MATERIALS APPLICATION	PERFORMANCE	ORDER NO.	PAGE
400	32	96	4,0	3,2	6°	TCG	NON-FERROUS	★★★★★	284.096.16P	54
400	32	96	4,0	3,2	-6° Neg.	TCG	NON-FERROUS	★★★★★	297.108.16P	55
400	32	120	4,0	3,2	-6° Neg.	TCG	NON-FERROUS	★★★★★	297.120.16P	55
400	60	72	4,4	3,2	16°	TCG	WOOD	★★★★	282.072.16U	48
400	70	28+6	4,0	2,8	18°	10° ATB	WOOD	★★★★	279.028.16V	18
400	75	60	4,4	3,2	16°	TCG	WOOD	★★★★	282.060.16X	48
400	75	72	4,4	3,2	16°	TCG	WOOD	★★★★	282.072.16X	48
400	75	72	4,4	3,2	16°	TCG	WOOD	★★★★★	282.400.72X	49
400	80	60	4,4	3,2	16°	TCG	WOOD	★★★★	282.060.16W	48
400	80	72	4,4	3,2	16°	TCG	WOOD	★★★★	282.072.16W	48
400	80	72	4,4	3,2	15°	TCG	WOOD	★★★★★	282.400.72W	49
420	32	96	3,8	3,2	6°	TCG	NON-FERROUS	★★★★★	284.096.17P	54
420	80	72	4,4	3,2	15°	TCG	WOOD	★★★★	282.072.17W	48
430	65	72	4,4	3,2	16°	TCG	WOOD	★★★★	Y282.072.17J	48
430	75	72	4,4	3,2	16°	TCG	WOOD	★★★★	282.072.17X	48
430	80	72	4,4	3,2	16°	TCG	WOOD	★★★★	282.072.17W2	48
450	30	32	3,8	2,8	15°	5° ATB	WOOD	★★★★★	286.032.18M	10
450	30	36	3,8	2,8	20°	10° ATB	WOOD	★★★★★	285.036.18M	21
450	30	54	3,8	2,8	15°	15° ATB	WOOD	★★★★★	285.054.18M	25
450	30	66	3,8	2,8	10°	15° ATB	WOOD	★★★★★	285.066.18M	29
450	30	72	4,4	3,2	16°	TCG	WOOD	★★★★	Y282.072.18M2	48
450	30	96	4,2	3,5	-6° Neg.	TCG	NON-FERROUS	★★★★★	297.108.18M	55
450	30	108	4,2	3,5	6°	TCG	NON-FERROUS	★★★★★	284.108.18M	54
450	30	120	4,2	3,5	-6° Neg.	TCG	NON-FERROUS	★★★★★	Y297.140.18M	55
450	32	96	4,2	3,5	-6° Neg.	TCG	NON-FERROUS	★★★★★	297.108.18P	55
450	32	108	4,2	3,5	6°	TCG	NON-FERROUS	★★★★★	284.108.18P	54
450	32	120	4,2	3,5	-6° Neg.	TCG	NON-FERROUS	★★★★★	297.120.18P	55
450	60	72	4,8	3,5	16°	TCG	WOOD	★★★★	282.072.18U	48
450	60	72	4,8	3,5	15°	TCG	WOOD	★★★★★	282.450.72U	49
450	80	72	4,8	3,5	16°	TCG	WOOD	★★★★	282.072.18W2	48
500	30	36	3,8	2,8	15°	5° ATB	WOOD	★★★★★	286.036.20M	10
500	30	44	4,0	2,8	20°	10° ATB	WOOD	★★★★★	285.044.20M	21
500	30	60	3,8	2,8	15°	15° ATB	WOOD	★★★★★	285.060.20M	25
500	30	72	3,8	2,8	10°	15° ATB	WOOD	★★★★★	285.072.20M	29
500	30	120	4,3	3,5	10°	TCG	NON-FERROUS	★★★★★	284.120.20M	54
500	30	120	4,3	3,5	-6° Neg.	TCG	NON-FERROUS	★★★★★	297.120.20M	55
500	32	120	4,3	3,5	10°	TCG	NON-FERROUS	★★★★★	284.120.20P	54
500	32	120	4,3	3,5	-6° Neg.	TCG	NON-FERROUS	★★★★★	297.120.20P	55
500	60	72	4,8	3,5	16°	TCG	WOOD	★★★★	282.072.20U	48
550	30	40	4,2	3,2	15°	5° ATB	WOOD	★★★★★	286.040.22M	10
550	30	60	4,2	3,2	10°	15° ATB	WOOD	★★★★★	285.060.22M	25
550	30	96	4,2	3,2	10°	15° ATB	WOOD	★★★★★	285.096.22M	29
600	30	40	4,2	3,2	15°	5° ATB	WOOD	★★★★★	286.040.24M	10
600	30	66	4,2	3,2	10°	15° ATB	WOOD	★★★★★	285.066.24M	25
700	30	46	4,4	3,2	15°	5° ATB	WOOD	★★★★★	286.046.28M	10
700	30	72	4,4	3,2	10°	15° ATB	WOOD	★★★★★	285.072.28M	25

QUALITY MATERIALS FOR OUTSTANDING PERFORMANCE

Designed and crafted using state-of-the-art processes as well as high-tech machinery these jig saw blades carry out precise cuts on a variety of materials: soft & hardwood, plywood, OSB, laminates, plastics, HPL, multiplex panels, metals, ferrous & non-ferrous materials, aluminium, Fibreglass as well as stainless steel. CMT jig saw blades come in four different materials made to outperform the competition and deliver impressive results.

GEOMETRY IS IMPORTANT!

MILLED & SIDE SET TEETH

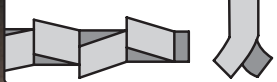

MILLED & SIDE SET TEETH

Jig saw blades featuring this kind of geometry produce a quick rough cut into soft/hardwood, aluminium, plastic and non-ferrous metals.

MILLED & WAVY SET TEETH



MILLED & WAVY SET TEETH

Suitable for fine straight cuts into plywood, soft steel, aluminium, non-ferrous metals and plastic.

GROUND & SIDE SET TEETH

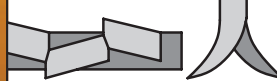

GROUND & SIDE SET TEETH

Best for quick cuts in wood.

GROUND & TAPER GROUND TEETH



GROUND & TAPER GROUND TEETH

This geometric attribute creates fine, clean and precise cuts in wood and plastic.



HIGH CARBON STEEL

Great for cutting wood, fiberboard and plastic.



BI-METAL WITH 8% COBALT

Premium bi-metal with 8% Cobalt provides superb results and guarantees long life when cutting metal, non-ferrous, plastic and wood with nails.



HIGH SPEED STEEL

For cutting harder materials, such as metals, aluminium and non-ferrous metals.



TUNGSTEN CARBIDE TIPPED

For cutting fibercement board, brick, porous concrete, plasterboard, MDF, Fibreglass and ETERNIT®.

THE RIGHT BLADE FOR THE BEST RESULTS!

A quick reference chart and pictograms will help you select the right blade for your application.

/// Wood



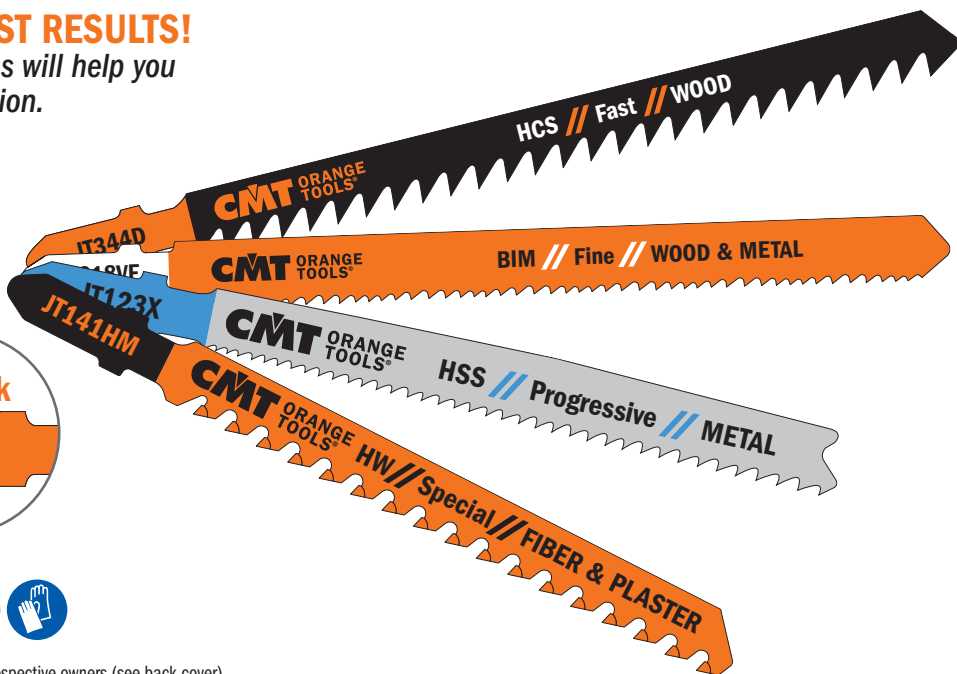

/// Wood & Metal

/// Metal

/// Special



Guide to Choosing the Most Suitable Jig Saw Blade

SERIES	MATERIAL	THICKNESS  mm	LINE	FINE STRAIGHT	COARSE STRAIGHT	FINE CURVE	COARSE CURVE	PAGE	
									
WOOD	Softwood	1,5~15	Fine			JT101AO		86	
		2~15	Basic			JT119BO		85	
		3~65	Fine, Splinter-Free	JT234X					87
		3~30	Fine	JT101B					86
		3~30	Fine, Splinter-Free	JT101BR					86
		4~60	Basic			JT111C			85
		5~60	Fast			JT144D		JT244D - JT244DDC	85
		5~100	Fast			JT344D			86
		7~55	Fine	JT101D					87
	7~65	Fine	JT301CD - JT318VF					87	
	Hardwood	1,5~15	Fine				JT101AO		86
		3~30	Fine	JT101B					86
		3~30	Fine, Splinter-Free	JT101BR					86
		3~65	Fine, Splinter-Free	JT234X					87
		5~60	Fast			JT144D		JT244D - JT244DDC	85
		5~100	Fast			JT344D			86
		7~55	Fine	JT101D					87
		7~65	Fine	JT301CD - JT318VF					87
		OSB	2~15	Basic				JT119BO	
	3~30		Fine	JT101B					86
	4~60		Basic			JT111C			85
	5~60		Fast			JT144D		JT244D - JT244DDC	85
	7~55		Fine	JT101D - JT318VF					87
	Plywood	1,5~15	Fine				JT101AO		86
		2~15	Basic				JT119BO		85
		3~30	Fine	JT101B					86
		3~30	Fine, Splinter-Free	JT101BR					86
		3~65	Fine, Splinter-Free	JT234X - JT318VF					87
		4~60	Basic			JT111C			85
		5~60	Fast			JT144D		JT244D - JT244DDC	85
		5~100	Fast			JT344D			86
		7~55	Fine	JT101D - JT318VF					87
	Construction Wood	<30	Fine	JT101B					86
		3~65	Fine, Splinter-Free	JT234X					87
		<100	Fast			JT344D			86
		<135	Fast			JT144D			85
	Chipboard	2~15	Basic				JT119BO		85
		3~30	Fine	JT101B			JT101AO		86
		3~65	Fine, Splinter-Free	JT234X - JT318VF					87
		4~60	Basic			JT111C			85
		5~60	Fast			JT144D		JT244D - JT244DDC	85
	Laminated panels Kitchen Tops Worktops	1,5~15	Fine				JT101AO		86
		1,5~15	Fine, Long Life	JT101BIF					87
		3~30	Fine	JT101B					86
		3~30	Fine, Splinter-Free	JT101BR					86
3~65		Fine, Splinter-Free	JT234X					87	
METAL	Sheet metals	1~3	Basic	JT118A		JT218A		88	
		1,5~10	Fast, Long Life	JT123X - JT318VF				87-88	
		2,5~6	Basic	JT118B				88	
	Aluminium, non-ferrous	<30	Fast	JT127D					88
		1,5~10	Fast	JT123X - JT318VF				87-88	
	Pipes	<30	Fast	JT123X - JT318VF				87-88	
	Inox Sheets	1,5~3	Fast	JT123X - JT318VF				87-88	
	Sandwich Material	<120	Fast, Flexible	JT718BF				88	
	GRP (Fibreglass)	<30	Fast	JT127D				88	
	Plastic (PP, PE, PVC, PA, PS)	<30	Fine	JT101D					87
<30		Fast	JT123X					88	
7~65		Fine	JT301CD - JT318VF					87	
SPECIAL	Plasterboard	5~50	Special			JT141HM		89	
		5~80	Special			JT341HM		89	
	GRP (Fibreglass)	<80	Special			JT341HM		89	
	Fibre cement boards	5~50	Special			JT141HM		89	
		5~80	Special			JT341HM		89	
	Carton, Leather, Rubber	<100	Special	JT313AW				89	
Soft Tile, Cast Iron	5~10	Special	JT150RF				89		

Jig Saw Blades

JT119B0



PACK Quantity	L mm	I mm	TS mm	TPI		ORDER NO. T Shank
5	76	50	2	12	100	JT119B0-5

Curve cuts on softwood (2~15mm), plywood, OSB.

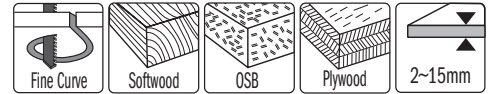

JT111C



PACK Quantity	L mm	I mm	TS mm	TPI		ORDER NO. T Shank
5	100	75	3	8	100	JT111C-5

Fast coarse cuts on softwood (4~60mm), plywood, OSB.

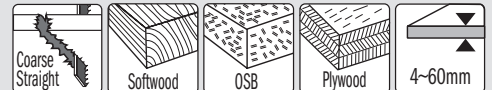
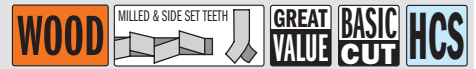

JT144D



PACK Quantity	L mm	I mm	TS mm	TPI		ORDER NO. T Shank
5	100	75	4	6	100	JT144D-5
25	100	75	4	6	10	JT144D-25
100	100	75	4	6	4	JT144D-100

Very fast cuts, straight and coarse, on hard/softwood (5~60mm), plywood, OSB. Plunge cutting.

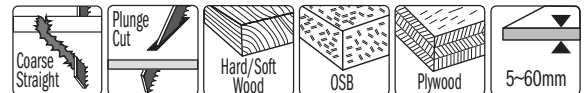

JT244D



PACK Quantity	L mm	I mm	TS mm	TPI		ORDER NO. T Shank
5	100	75	4	6	100	JT244D-5

Fast, curve, coarse cut on soft and hardwood (5~60mm), plywood, OSB. Plunge cutting.

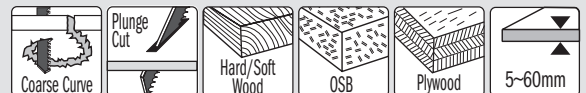

JT244DDC



PACK Quantity	L mm	I mm	TS mm	TPI		ORDER NO. T Shank
5	100	75	4	6	100	JT244DDC-5

Fast, curve, coarse cut on soft and hardwood (5~60mm), plywood, OSB. Plunge cutting. Special "DUO" (double) cuts for fast curve cutting.

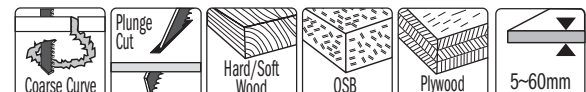

Jig Saw Blades



JT344D



PACK Quantity	L mm	I mm	TS mm	TPI		ORDER NO. T Shank
5	132	110	4	6	100	JT344D-5

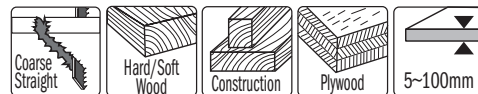

Very fast cuts, straight and coarse on thick construction timber, hard/softwood (5~100mm), plywood, OSB.

JT744D



PACK Quantity	L mm	I mm	TS mm	TPI		ORDER NO. T Shank
3	180	155	4	6	20	JT744D-3



Very fast cuts, straight and coarse on thick construction timber, hard/softwood (5~135mm) and sandwich material.

JT101AO

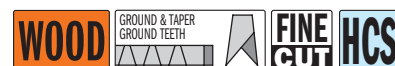

PACK Quantity	L mm	I mm	TS mm	TPI		ORDER NO. T Shank
5	76	50	1,4	20	100	JT101AO-5

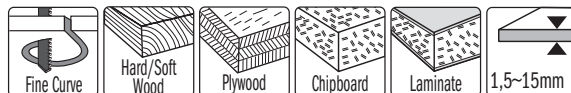

Curved cuts, fine finishing on both sides of surface on hard/softwood, plywood, chipboard, MDF, double sided laminates (1,5~15mm).

JT101B



PACK Quantity	L mm	I mm	TS mm	TPI		ORDER NO. T Shank
5	100	75	2,5	10	100	JT101B-5
25	100	75	2,5	10	10	JT101B-25

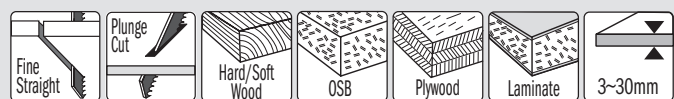

Fine straight cuts with fine finishing on hard/softwood, plywood, OSB and plastics (3~30mm). Plunge cutting.

JT101BR

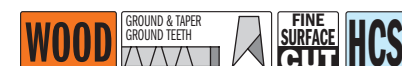

PACK Quantity	L mm	I mm	TS mm	TPI		ORDER NO. T Shank
5	100	75	2,5	10	100	JT101BR-5
25	100	75	2,5	10	10	JT101BR-25

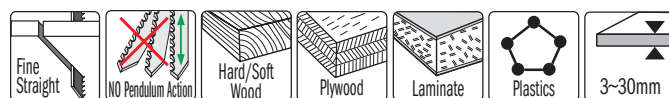

Straight cuts, fine finishing on upper side, hard/softwood, plywood, OSB, laminated panels, plastics (3~30mm). Reverse tooth.

Jig Saw Blades

JT101D



WOOD GROUND & TAPER GROUND TEETH **FINE CUT** **HCS**

PACK Quantity	L mm	I mm	TS mm	TPI		ORDER NO. T Shank
5	100	75	4	6	100	JT101D-5

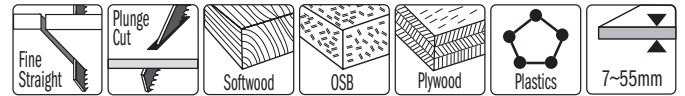

Straight cuts, fine finishing on upper side, on hard/softwood, plywood, OSB, laminates and plastics (7~55mm). Plunge cutting.

JT301CD

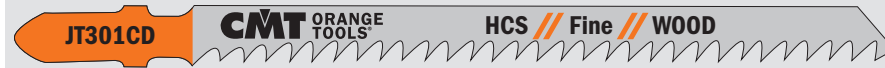

WOOD GROUND & TAPER GROUND TEETH **FINE CUT** **HCS**

PACK Quantity	L mm	I mm	TS mm	TPI		ORDER NO. T Shank
5	116	90	3	8	100	JT301CD-5

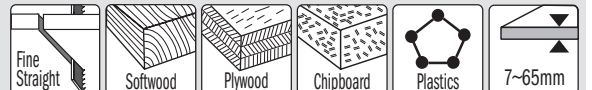

Straight cuts, good finishing, on hard/softwood, plywood, laminates and plastics (7~65mm).

JT234X



WOOD GROUND & TAPER GROUND TEETH **SPLINTER FREE CUT** **HCS**

PACK Quantity	L mm	I mm	TS mm	TPI		ORDER NO. T Shank
5	116	90	2-3	8-12	100	JT234X-5



Extra-clean straight cuts, splinter-free finish, on hard/softwood, plywood, OSB, laminates (3~65mm).

JT101BIF



WOOD GROUND & TAPER GROUND TEETH **LONG LIFE** **SPLINTER FREE CUT** **FINE CUT** **BIM 8% Co**

PACK Quantity	L mm	I mm	TS mm	TPI		ORDER NO. T Shank
5	83	58	1,7	15	100	JT101BIF-5

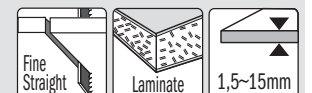

Splinter-free cuts. Special for all laminates, HPL and multiplex panels (1,5~15mm).

JT318VF



WOOD&METAL SIDE SET TEETH

EASY CUT **LONG LIFE** **BIM 8% Co**

PACK Quantity	L mm	I mm	TS mm	TPI		ORDER NO. T Shank
5	132	100	1,7-2,6	10-15	100	JT318VF-5

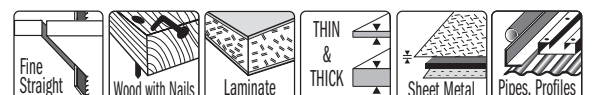

Straight cuts on wood with nails/metal, chipboard and laminate (<60mm), sheet metal, aluminium profiles (3~18mm), glass fiber reinforced plastic/epoxy (<60mm).

Jig Saw Blades

JT118A



PACK Quantity	L mm	I mm	TS mm	TPI		ORDER NO. T Shank
5	76	50	1,2	21	100	JT118A-5

Straight cuts on thin sheet metals, ferrous and non-ferrous (1~3mm).



JT218A



PACK Quantity	L mm	I mm	TS mm	TPI		ORDER NO. T Shank
5	76	50	1,2	21	100	JT218A-5

Curve cuts on thin sheet metals, ferrous and non-ferrous (1~3mm).



JT118B



PACK Quantity	L mm	I mm	TS mm	TPI		ORDER NO. T Shank
5	76	50	2	12	100	JT118B-5

Straight cuts on medium-thick metals, ferrous and non-ferrous (2,5~6mm).



JT123X



PACK Quantity	L mm	I mm	TS mm	TPI		ORDER NO. T Shank
5	100	75	1,2-2,6	10-21	100	JT123X-5

Straight cuts on thin to thick sheet metals (1,5~10mm), pipes, profiles in plastic and aluminium (<30mm), stainless steel (1,5~3mm).

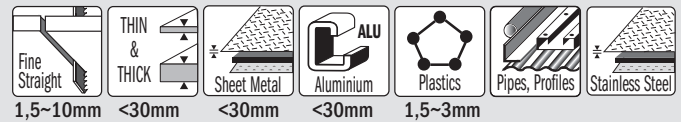

JT127D



PACK Quantity	L mm	I mm	TS mm	TPI		ORDER NO. T Shank
5	100	75	3	8	100	JT127D-5

Special for aluminium, thin to thick (3~15mm), pipes and profiles, (<30mm) including plastic, fibreglass and epoxy.

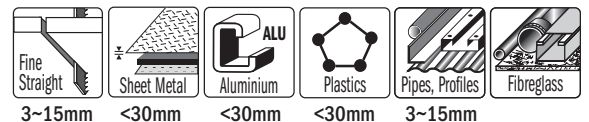

JT718BF



PACK Quantity	L mm	I mm	TS mm	TPI		ORDER NO. T Shank
3	185	160	1,8	14	20	JT718BF-3

Special for Sandwich Materials & Solid Surfaces (<120mm).

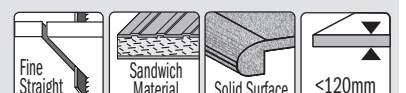

Jig Saw Blades



JT141HM

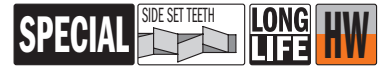

PACK Quantity	L mm	I mm	TS mm	TPI		ORDER NO. T Shank
3	100	75	4,3	6	50	JT141HM-3

Plasterboard, fibre cement boards (<50mm). Fibreglass/Epoxy (5~20mm), ETERNIT®, MDF, HDF.

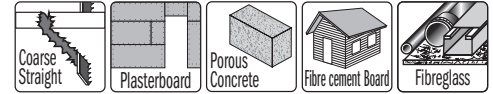

JT341HM



PACK Quantity	L mm	I mm	TS mm	TPI		ORDER NO. T Shank
3	132	110	4,3	6	50	JT341HM-3

Plasterboard, fibre cement boards (<80mm). Fibreglass/Epoxy (5~50mm), ETERNIT®, MDF, HDF.



JT150RF



PACK Quantity	L mm	I mm				ORDER NO. T Shank
3	83	75			50	JT150RF-3

Soft ceramic tiles, cast iron (5-10mm), reinforced fibreglass.



JT313AW



PACK Quantity	L mm	I mm				ORDER NO. T Shank
3	152	100			100	JT313AW-3

Cardboard, polystyrene, carpet, leather, rubber, fibreglass thermal insulation panels (<100mm).

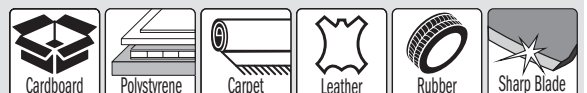

JT016 16 Piece Jig Saw Blade Set

	JT144D	HCS	WOOD	FAST CUT		JT141HM	HW	SPECIAL	LONG LIFE
	JT101B	HCS	WOOD	FINE CUT		JT123X	HSS	METAL	FAST CUT
	JT101BR	HCS	WOOD	FINE SURFACE CUT		JT118A	HSS	METAL	BASIC CUT
	JT101BIF	BIM	WOOD	FINE CUT		JT118B	HSS	METAL	BASIC CUT
	JT101A0	HCS	WOOD	FINE CUT		JT218A	HSS	METAL	BASIC CUT

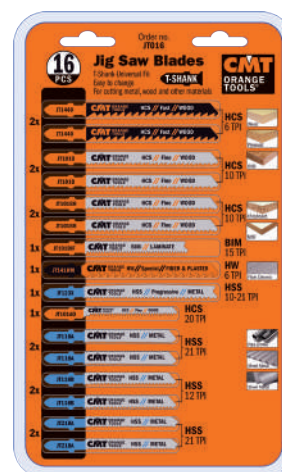

15 Sets in End-cap display (minimum 15 pieces or multiple)



An assortment of 16 Jig Saw Blades featuring the 10 most popular blades for a variety of cutting needs:

- wood and timber (straight, curve cuts, course cutting and finishing);
- plasterboard, fibre cement, fibreglass, epoxy resins, and panels such as ETERNIT®;
- metal and sheet metal both thick and thin;
- stainless steel;
- aluminium and plastics.

© Brand names mentioned in CMT products are the property of their respective owners (see back cover)



GEOMETRY IS IMPORTANT!

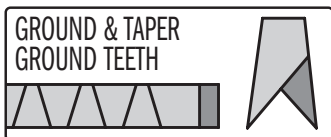

**GROUND & TAPER
GROUND TEETH**
Easily cut construction wood,
plywood, framing lumber and
plastic.

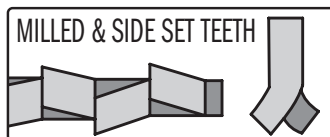

MILLED & SIDE SET TEETH
For quick cutting on
hard/softwood, aluminium,
plastic, ferrous
and non-ferrous metal.

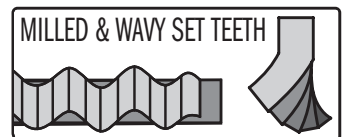

MILLED & WAVY SET TEETH
For fine, precise cuts in
thin/thick metal, pipe,
open and closed profiles.



HIGH CARBON STEEL
For cuts on soft wood
or plastic.



BI-METAL WITH 8% COBALT
Provides superb results and guarantees long
life when cutting metals, plastic and wood
with nails.



**TUNGSTEN CARBIDE
TIPPED**
Ideal for construction materials:
fibre cement board,
brick and porous concrete.



QUALITY MATERIALS FOR MAXIMUM PRODUCTIVITY

Produced by following state-of-the-art processes, using high-tech machines and premium quality raw materials, these sabre saw blades have been specifically designed to ensure maximum lifetime and performance in all materials.

THE RIGHT BLADE FOR THE JOB!

Use our quick reference chart and pictograms to help you choose the best blade for your application.



NON-STICK ORANGE SHIELD COATING®

Keeps the blade running cool, reduces pitch build up and protects against corrosion. Ideal for all types of wood including wet lumber.

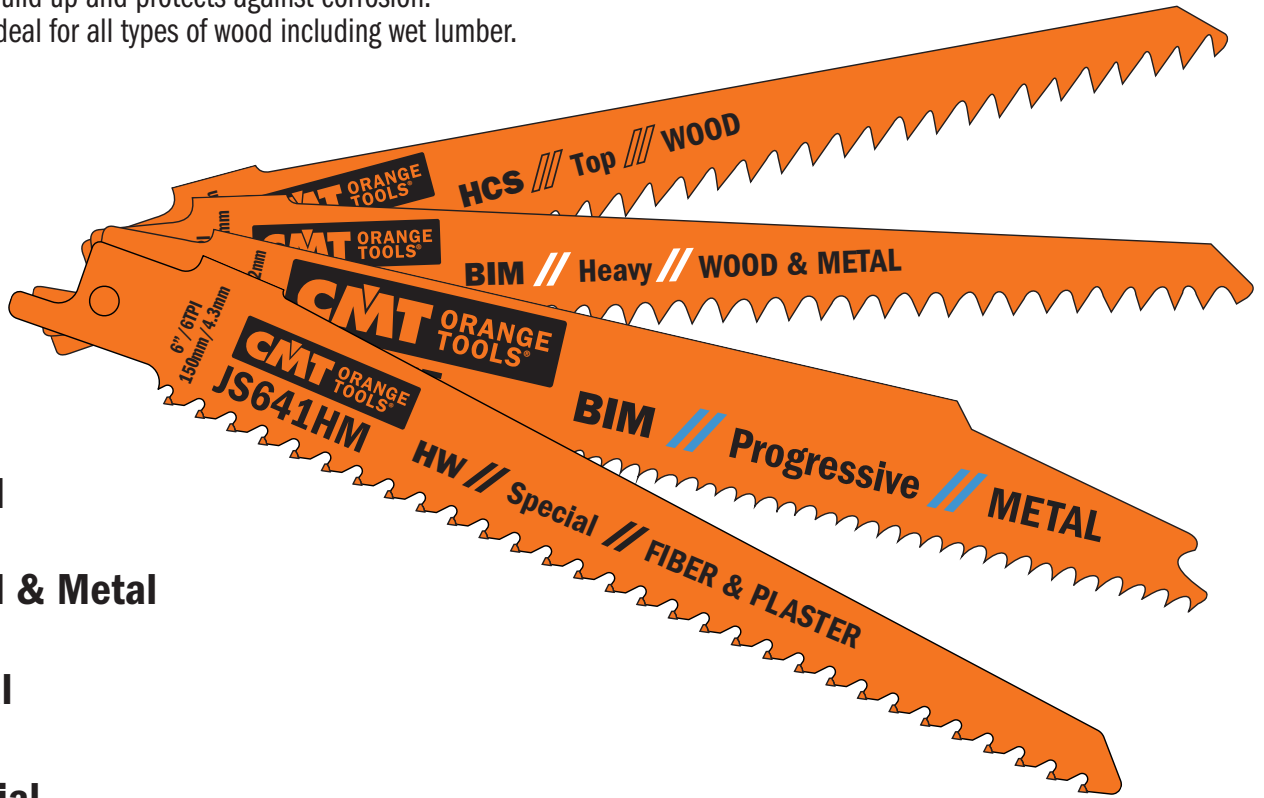

Wood

Wood & Metal

Metal

Special

BLADE LINE DESCRIPTIONS

Different blade lines help you choose the right blade for the task.

- BASIC:** Cost effective
- FLEXIBLE:** Breakproof, long lifetime
- PROGRESSIVE:** Fast cutting through thin and thick material
- TOP:** Fast and efficient
- HEAVY:** Sturdy and precise

12,7mm (1/2") UNIVERSAL SHANK

Fits: AEG®, BLACK & DECKER®, BOSCH®, DEWALT®, FEIN®, FLEX®, HILTI®, MAKITA®, METABO®, MILWAUKEE®, PORTER CABLE®, RIDGID®, ROTHENBERGER®, RYOBI®, SKIL®.

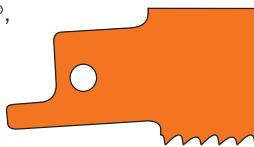

BLADE SHAPE & THICKNESS

Sabre Saw Blades vary in shape and thickness. These two characteristics are adjusted according to the demands of the application as well as the required flexibility. Rigorous applications such as cutting tube and pipe require thick robust blades, while less demanding applications require narrower blades.

Three Main Blade Categories:

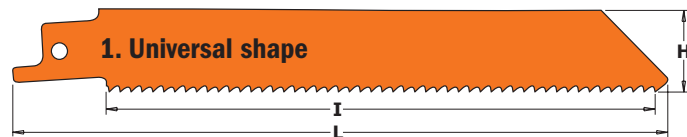

1. Universal shape

Universal blades are for general use. Their even width guarantees good cutting stability and excellent control. This enables straight edge cutting through many different materials.

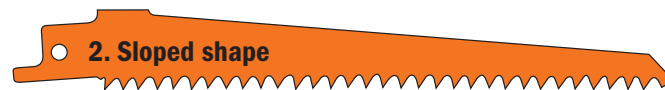

2. Sloped shape



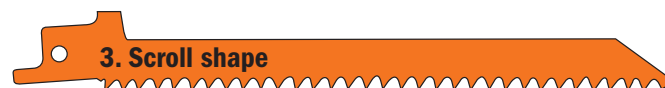





Sloped blades are commonly used for cutting wood and for demolition applications. Their narrow tip allows for plunge and curve cutting. This shape is rarely used for metal, since the tip does not have the strength required for this application.



3. Scroll shape

Scroll blades are especially used for curve cutting. The narrower the blade, the smaller the radius it can cut.

Sabre Saw Blade Application Chart

SERIES	MATERIAL	MATERIAL THICKNESS  mm	LINE	L MM	FINE STRAIGHT	COARSE STRAIGHT	CURVE	FINE ANGLE CUT	FLUSH CUT	THIN & THICK	DEMOLITION	TPI	PAGE	
														
WOOD & METAL	Glass fibre-reinforced plastic/epoxy Coolant: water MAX RPM 500	<60	Heavy	225		JS1111DF						6	95	
		<60	Heavy	225		JS1110VF		JS1110VF			JS1110VF	5-8	96	
		<175	Heavy	225		JS1156XHM		JS1156XHM			JS1156XHM	5-8	98	
		<100	Flexible	150	JS922VF	JS641HM							10-14	97, 101
		<150	Progressive	200		JS3456XF					JS3456XF		6-12	96
		<175	Flexible	225	JS1122VF					JS1122HF			10-14	97
		<175	Progressive	225		JS5678XF					JS5678XF		6-12	96
		<250	Flexible	300	JS1222VF					JS1222VF			10-14	97
	<250	Heavy	300		JS1210VF		JS1210VF			JS1210VF	5-8	96		
METAL	Sheet, perforated metals, (thin & thick) Coolant: dry MAX RPM 500~2000	0,7~3	Flexible	150	JS922AF							24	100	
		0,7~3	Flexible	225	JS1122AF				JS1122AF			24	100	
		1~8	Progressive	150	JS123XF						JS123XF		8-14	99
		1,5~4	Flexible	150	JS922EF								18	100
		1,5~4	Flexible	225	JS1122EF					JS1122EF			18	100
		2~10	Heavy	150	JS925VF							JS925VF	10-14	99
		2~10	Heavy	200	JS1025VF							JS1025VF	10-14	99
		2~10	Heavy	225	JS1125VF							JS1125VF	10-14	99
		2~10	Heavy	300	JS1125VF							JS1225VF	10-14	99
		3~8	Flexible	150	JS922BF								14	100
		3~8	Flexible	225	JS1122BF					JS1122BF			14	100
		4~12	Heavy	150		JS920CF		JS920CF				JS920CF	9	98
	4~12	Heavy	150		JS955CHM		JS955CHM				JS955CHM	9	98	
	4~12	Heavy	225		JS1120CF		JS1120CF				JS1120CF	9	99	
	4~12	Heavy	225		JS1155CHM		JS1155CHM				JS1155CHM	9	98	
	Pipes, profiles, thin-walled (open & closed) Coolant: dry MAX RPM 500~2000	<100	Flexible	150	JS922AF								24	100
		<100	Flexible	150	JS922EF								18	100
		<100	Progressive	150	JS123XF						JS123XF		8-14	99
		<100	Heavy	150	JS925VF						JS925VF		10-14	99
		<150	Heavy	200	JS1025VF						JS1025VF		10-14	99
		<175	Flexible	225	JS1122AF					JS1122AF			24	100
		<175	Flexible	225	JS1122EF					JS1122EF			18	100
		<175	Heavy	225	JS1125VF						JS1125VF		10-14	99
	Pipes, profiles, thick-walled (open & closed) Coolant: dry MAX RPM 500~2000	<250	Heavy	300	JS1225VF						JS1225VF		10-14	99
		<100	Flexible	150	JS922BF								14	100
		<100	Progressive	150	JS123XF						JS123XF		8-14	99
		<100	Heavy	150	JS925VF						JS925VF		10-14	99
		<100	Heavy	150		JS920CF		JS920CF			JS920CF		9	98
		4~12	Heavy	150		JS955CHM		JS955CHM			JS955CHM		9	98
		<150	Heavy	200	JS1025VF						JS1025VF		10-14	99
		<175	Flexible	225	JS1122BF					JS1122BF			14	100
		<175	Heavy	225	JS1125VF						JS1125VF		10-14	99
		<175	Heavy	225		JS1120CF		JS1120CF			JS1120CF		9	99
		4~12	Heavy	225		JS1155CHM		JS1155CHM			JS1155CHM		9	98
		Pipes, profiles (solid) Coolant: cutting oil MAX RPM 500~2000	<250	Heavy	300	JS1225VF						JS1225VF		10-14
	<100		Progressive	150	JS123XF						JS123XF		8-14	99
<100	Flexible		150	JS922BF								14	100	
<100	Heavy		150		JS920CF		JS920CF			JS920CF		9	98	
4~12	Heavy		150		JS955CHM		JS955CHM			JS955CHM		9	98	
<175	Flexible		225	JS1122BF					JS1122BF			14	100	
<175	Heavy		225		JS1120CF		JS1120CF			JS1120CF		9	99	
4~12	Heavy		225		JS1155CHM		JS1155CHM			JS1155CHM		9	98	
SPECIAL	Plasterboard	<100	Heavy	150	JS641HM	JS611DF	JS711DF					6	101, 95	
	Fibre cement panels	<175	Special	225		JS1141HM		JS1141HM					3	101
		<215	Special	305		JS1243HM		JS1243HM					2	101
		<250	Special	300		JS1241HM		JS1241HM					3	101
		<365	Special	455		JS2243HM		JS2243HM					2	101
	Porous concrete, red brick	<175	Special	225		JS1141HM		JS1141HM					3	101
		<215	Special	305		JS1243HM		JS1243HM					2	101
		<250	Special	300		JS1241HM		JS1241HM					3	101
		<365	Special	455		JS2243HM		JS2243HM					2	101
	Polystyrene, fibre insulation	<175	Special	228		JS1113AWP-2							-	102
<250		Special	300		JS1213AWP							-	102	
<300		Special	300		JS2013AWP							-	102	
Ice, frozen, meat, bone	<250	Special	300		JS1211K						3	102		

TIP: Using a lubricant can extend blade lifetime up to 500%.

Sabre Saw Blades

JS617K



PACK Quantity	L mm	I mm	H mm	K mm	TS mm	TPI		ORDER NO. Universal Shank
5	150	130	19	1,25	8,5	3	10	JS617K-5

Cuts coarse wood, free of nails (<100mm), pruning green wood (diameter <100mm), excellent for curved and plunge cutting.

WOOD **GREAT VALUE** **BASIC CUT** **HCS**



JS1111K



PACK Quantity	L mm	I mm	H mm	K mm	TS mm	TPI		ORDER NO. Universal Shank
5	225	205	19	1,25	8,5	3	10	JS1111K-5

Coarse wood, free of nails (<175mm), firewood (diameter <175mm).

WOOD **GREAT VALUE** **BASIC CUT** **HCS**



JS1617K



PACK Quantity	L mm	I mm	H mm	K mm	TS mm	TPI		ORDER NO. Universal Shank
5	300	280	19	1,25	8,5	3	10	JS1617K-5

Coarse wood, free of nails (<250mm), pruning green wood (diameter <250mm).

WOOD **GREAT VALUE** **BASIC CUT** **HCS**



JS644D



PACK Quantity	L mm	I mm	H mm	K mm	TS mm	TPI		ORDER NO. Universal Shank
5	150	130	19	1,25	4,3	6	10	JS644D-5

Cuts construction wood (<100mm), wooden wall panels (<100mm), chipboard, MDF (6~60mm), plywood, plastic (<100mm). Special for plunge cutting.

WOOD **FINE CUT** **HCS**



JS1531L



PACK Quantity	L mm	I mm	H mm	K mm	TS mm	TPI		ORDER NO. Universal Shank
5	240	220	19	1,50	5	5	10	JS1531L-5

Coarse wood, free of nails (<190mm), pruning green wood (diameter <190mm), firewood (diameter <190mm).

WOOD **FAST CUT** **HCS**



JS2345X



PACK Quantity	L mm	I mm	H mm	K mm	TS mm	TPI		ORDER NO. Universal Shank
5	200	180	19	1,25	2,4-4	6-10	10	JS2345X-5

Cuts construction wood (<150mm), chipboard, MDF (6~60mm), plywood, plastic (<150mm), wooden wall (<150mm). Effortless fine cutting.

WOOD **FINE CUT** **EASY CUT** **HCS**



Sabre Saw Blades



JS611DF

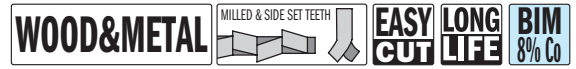

PACK Quantity	L mm	I mm	H mm	K mm	TS mm	TPI		ORDER NO. Universal Shank
5	150	130	19	1,25	4,3	6	10	JS611DF-5

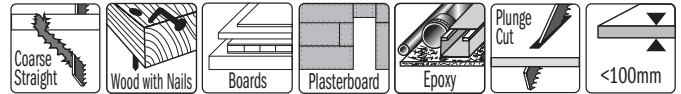

Cuts wood with nails/embedded metal (<100mm), plastic profiles (<100mm), fibreglass and epoxy (<50mm), wood and metal window frames. Special for plunge cutting.

JS711DF

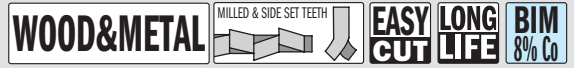

PACK Quantity	L mm	I mm	H mm	K mm	TS mm	TPI		ORDER NO. Universal Shank
5	150	130	12	1,25	4,3	6	10	JS711DF-5

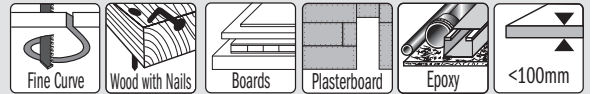

Cuts wood with nails/embedded metal (<100mm), fibreglass and epoxy (<50mm). Excellent for curved cuts.

JS1111DF

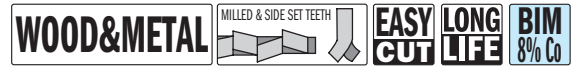

PACK Quantity	L mm	I mm	H mm	K mm	TS mm	TPI		ORDER NO. Universal Shank
5	225	205	19	1,25	4,3	6	10	JS1111DF-5
20	225	205	19	1,25	4,3	6	5	JS1111DF-20



For cutting wood with nails/embedded metal, chipboard (<175mm), plastic profiles (<175mm), fibreglass and epoxy (<50mm).

JS1411DF

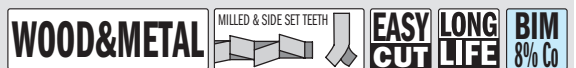

PACK Quantity	L mm	I mm	H mm	K mm	TS mm	TPI		ORDER NO. Universal Shank
5	300	280	19	1,25	4,3	6	10	JS1411DF-5

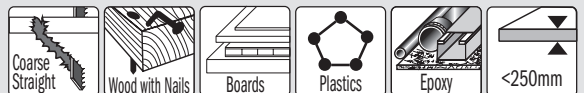

Cuts wood with nails/embedded metal, chipboard (<250mm), fibreglass and epoxy (<60mm).

JS610VF

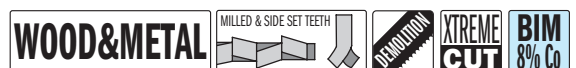

PACK Quantity	L mm	I mm	H mm	K mm	TS mm	TPI		ORDER NO. Universal Shank
5	150	130	22	1,60	3,2-5	5-8	10	JS610VF-5



Cuts wood with nails/metal, wood, chipboard (<100mm), fibreglass and epoxy (<100mm), wood and metal wall cut-outs, (<100mm). Excellent for rescue/demolition work.

Sabre Saw Blades



JS1110VF

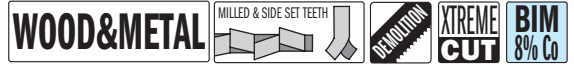

PACK Quantity	L mm	I mm	H mm	K mm	TS mm	TPI		ORDER NO. Universal Shank
5	225	205	22	1,60	3,2-5	5-8	10	JS1110VF-5
20	225	205	22	1,60	3,2-5	5-8	5	JS1110VF-20

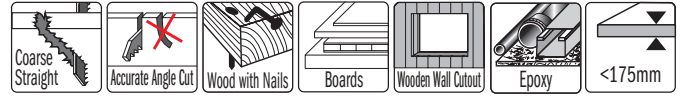

For cutting wood with nails/embedded metal, chipboard (<175mm), fibreglass and epoxy, wood and metal wall cut-outs (<175mm). For rescue and demolition work.

JS1210VF

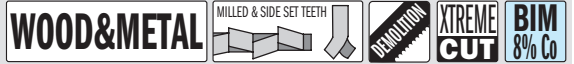

PACK Quantity	L mm	I mm	H mm	K mm	TS mm	TPI		ORDER NO. Universal Shank
5	300	280	22	1,60	3,2-5	5-8	10	JS1210VF-5



Cuts wood with nails/embedded metal, wood, chipboard (<250mm), fibreglass and epoxy (<250mm), wood and metal wall cut-outs (<250mm).

JS3456XF



PACK Quantity	L mm	I mm	H mm	K mm	TS mm	TPI		ORDER NO. Universal Shank
5	200	180	19	1,25	2,1-4,3	6-12	10	JS3456XF-5
20	200	180	19	1,25	2,1-4,3	6-12	5	JS3456XF-20

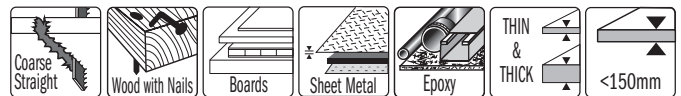

For cutting wood with nails/embedded metal (<150mm), sheet metal, pipe and aluminium profiles from (3~18mm) in thickness, fibreglass and epoxy (<150mm).

JS5678XF



PACK Quantity	L mm	I mm	H mm	K mm	TS mm	TPI		ORDER NO. Universal Shank
5	225	205	25	1,27	2,1-4,3	6-12	10	JS5678XF-5
20	225	205	25	1,27	2,1-4,3	6-12	5	JS5678XF-20



For cutting wood with nails or metal, chipboard (<175mm), sheet metal, aluminium profiles (3-18mm), glass fibre-reinforced plastic/epoxy (<175mm).

JS725VFR



PACK Quantity	L mm	I mm	H mm	K mm	TS mm	TPI		ORDER NO. Universal Shank
5	200	180	19	1,27	2,1-3,2	8-12	10	JS725VFR-5
20	200	180	19	1,27	2,1-3,2	8-12	5	JS725VFR-20



Special saw blade for pallet repair. Cutting depth <150mm. Optimized for reduced vibration.

Sabre Saw Blades



JS922HF

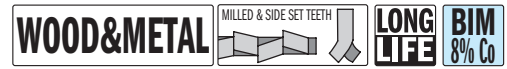

PACK Quantity	L mm	I mm	H mm	K mm	TS mm	TPI		ORDER NO. Universal Shank
5	150	130	19	0,90	2,5	10	10	JS922HF-5

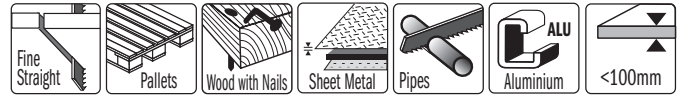

For pallet repair, wood with nails/embedded metal (<100mm), sheet metal, pipe, aluminium profiles (3~12mm).

JS1122HF

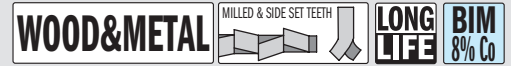

PACK Quantity	L mm	I mm	H mm	K mm	TS mm	TPI		ORDER NO. Universal Shank
5	225	205	19	0,90	2,5	10	10	JS1122HF-5
20	225	205	19	0,90	2,5	10	5	JS1122HF-20

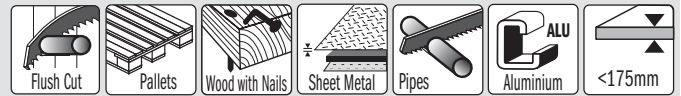

For pallet repair, wood with nails/embedded metal (<175mm), sheet metal, pipe, aluminium profiles (3~12mm). Flexible flush cutting.

JS922VF



PACK Quantity	L mm	I mm	H mm	K mm	TS mm	TPI		ORDER NO. Universal Shank
5	150	130	19	0,90	1,8-2,6	10-14	10	JS922VF-5

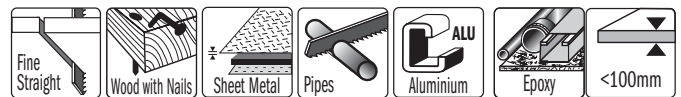

Cuts wood with nails/embedded metal (<100mm), sheet metal, pipe and aluminium profiles (3~10mm), fibreglass and epoxy (<100mm).

JS1122VF

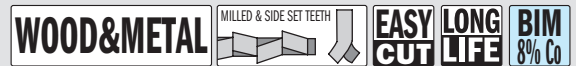

PACK Quantity	L mm	I mm	H mm	K mm	TS mm	TPI		ORDER NO. Universal Shank
5	225	205	19	0,90	1,8-2,6	10-14	10	JS1122VF-5



Cuts wood with nails/embedded metal (<175mm), sheet metal, aluminium profiles (3~10mm), fibreglass and epoxy (<175mm). Flexible flush cutting.

JS1222VF



PACK Quantity	L mm	I mm	H mm	K mm	TS mm	TPI		ORDER NO. Universal Shank
5	300	280	19	0,90	1,8-2,6	10-14	10	JS1222VF-5



Cuts wood with nails/embedded metal (<250mm), sheet metal, aluminium profiles (3~10mm), fibreglass and epoxy (<250mm). Flexible flush cutting.

Sabre Saw Blades



JS956XHM



PACK Quantity	L mm	I mm	H mm	K mm	TS mm	TPI		ORDER NO. Universal Shank
3	150	130	24	1,2	3-4	6-8	10	JS956XHM-3

For cutting wood with nails or metal (nails/metal hardness up to 40 HRC), repairing pallets, plasterboard, plastics, glass fibre-reinforced plastic/epoxy, fibre cement (<100mm). For rescue and demolition work.



JS1156XHM



PACK Quantity	L mm	I mm	H mm	K mm	TS mm	TPI		ORDER NO. Universal Shank
3	225	205	24	1,2	3-4	6-8	10	JS1156XHM-3

For cutting wood with nails or metal (nails/metal hardness up to 40 HRC), repairing pallets, plasterboard, plastics, glass fibre-reinforced plastic/epoxy, fibre cement (<175 mm). For rescue and demolition work.

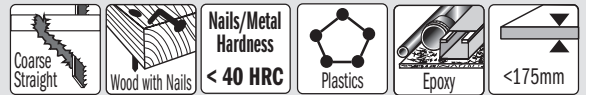

JS955CHM





PACK Quantity	L mm	I mm	H mm	K mm	TS mm	TPI		ORDER NO. Universal Shank
3	150	130	24	1,2	3	8	10	JS955CHM-3

For cutting thick sheet metal (4-12mm), pipes & profiles (<100mm), plastics, glass fibre-reinforced plastic/epoxy, fibre cement (<100mm), wood with nails or metal.

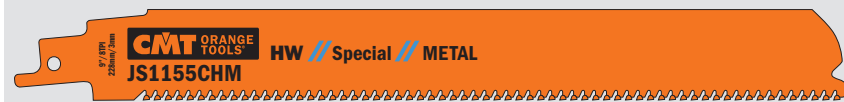

JS1155CHM



PACK Quantity	L mm	I mm	H mm	K mm	TS mm	TPI		ORDER NO. Universal Shank
3	225	205	24	1,2	3	8	10	JS1155CHM-3

For cutting thick sheet metal (4-12mm), pipes & profiles (<175mm), plastics, glass fibre-reinforced plastic/epoxy, fibre cement (<175mm), wood with nails or metal.

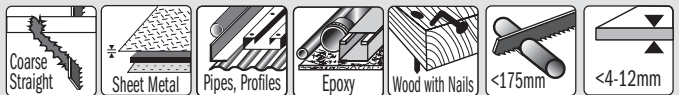

JS920CF



PACK Quantity	L mm	I mm	H mm	K mm	TS mm	TPI		ORDER NO. Universal Shank
5	150	130	22	1,60	2,9	9	10	JS920CF-5

Cuts thick sheet metal (4~12mm), thick-walled pipe and profiles (<100mm). Ideal for pipe cutting, for rescue/demolition work. Powerful coarse cutting.

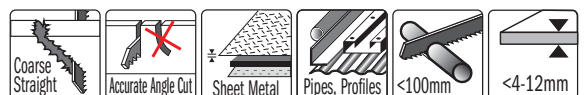

Sabre Saw Blades

JS1120CF



PACK Quantity	L mm	I mm	H mm	K mm	TS mm	TPI		ORDER NO. Universal Shank
5	225	205	22	1,60	2,9	9	10	JS1120CF-5
20	225	205	22	1,60	2,9	9	5	JS1120CF-20

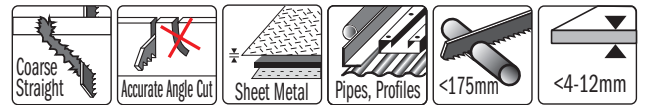

For cutting thick sheet metal (4~12mm), thick-walled pipe and profiles (<175mm). Ideal for pipe cutters, for rescue/demolition work. Powerful coarse cutting.

JS123XF

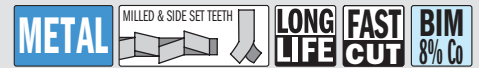

PACK Quantity	L mm	I mm	H mm	K mm	TS mm	TPI		ORDER NO. Universal Shank
5	150	130	19	0,90	1,8-3,2	8-14	10	JS123XF-5



Cuts thin sheet metal (1~8mm) pipes and profiles (diameter <100mm).

JS925VF



PACK Quantity	L mm	I mm	H mm	K mm	TS mm	TPI		ORDER NO. Universal Shank
5	150	130	19	1,25	1,8-2,6	10-14	10	JS925VF-5



Cuts medium-thick to thick sheet metal (2~10mm), thin and thick-walled pipe and profiles (<100mm). Ideal for demolition work in metal. Fine effortless cutting.

JS1025VF

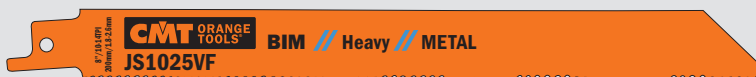

PACK Quantity	L mm	I mm	H mm	K mm	TS mm	TPI		ORDER NO. Universal Shank
5	200	180	19	1,25	1,8-2,6	10-14	10	JS1025VF-5



Cuts medium-thick to thick sheet metal (2~10mm), thin and thick-walled pipe and profiles (<150mm). Ideal for demolition work on metal. Fine effortless cutting.

JS1125VF



PACK Quantity	L mm	I mm	H mm	K mm	TS mm	TPI		ORDER NO. Universal Shank
5	225	205	19	1,25	1,8-2,6	10-14	10	JS1125VF-5



Cuts medium-thick to thick sheet metal (2~10mm), thin and thick-walled pipe and profiles (<175mm). Ideal for demolition work on metal. Fine effortless cutting.

JS1225VF



PACK Quantity	L mm	I mm	H mm	K mm	TS mm	TPI		ORDER NO. Universal Shank
5	300	280	19	1,25	1,8-2,6	10-14	10	JS1225VF-5



Cuts medium-thick to thick sheet metal (2~10mm), thin and thick-walled pipe and profiles (<250mm). Ideal for demolition work in metal. Fine effortless cutting.

Sabre Saw Blades

JS922BF



METAL MILLED & WAVY SET TEETH **LONG LIFE** **FAST CUT** **BIM 8% Co**

PACK Quantity	L mm	I mm	H mm	K mm	TS mm	TPI		ORDER NO. Universal Shank
5	150	130	19	0,90	1,8	14	10	JS922BF-5
20	150	130	19	0,90	1,8	14	5	JS922BF-20



Cuts thin sheet metal (3~8mm), thin pipe and profiles (diameter <100mm).
Fine effortless cutting.

JS1122BF



METAL MILLED & WAVY SET TEETH **LONG LIFE** **FAST CUT** **BIM 8% Co**

PACK Quantity	L mm	I mm	H mm	K mm	TS mm	TPI		ORDER NO. Universal Shank
5	225	205	19	0,90	1,8	14	10	JS1122BF-5
20	225	205	19	0,90	1,8	14	5	JS1122BF-20

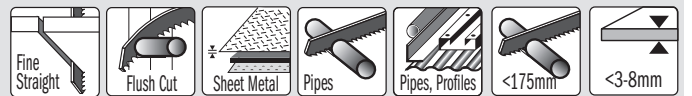

Cuts thin sheet metal (3~8mm), thin pipe and profiles (diameter <175mm).
Fine effortless cutting. Flexible flush cuts.

JS922EF



METAL MILLED & WAVY SET TEETH **LONG LIFE** **BIM 8% Co**

PACK Quantity	L mm	I mm	H mm	K mm	TS mm	TPI		ORDER NO. Universal Shank
5	150	130	19	0,90	1,4	18	10	JS922EF-5
20	150	130	19	0,90	1,4	18	5	JS922EF-20



Cuts thin sheet metal (1,5~4mm), pipe and profiles (diameter <100mm).

JS1122EF



METAL MILLED & WAVY SET TEETH **LONG LIFE** **BIM 8% Co**

PACK Quantity	L mm	I mm	H mm	K mm	TS mm	TPI		ORDER NO. Universal Shank
5	225	205	19	0,90	1,4	18	10	JS1122EF-5
20	225	205	19	0,90	1,4	18	5	JS1122EF-20



Cuts thin sheet metal (1,5~4mm), pipe and profiles (diameter <175mm).
Flexible flush cuts.

JS922AF



METAL MILLED & WAVY SET TEETH **EASY CUT** **FINE CUT** **LONG LIFE** **BIM 8% Co**

PACK Quantity	L mm	I mm	H mm	K mm	TS mm	TPI		ORDER NO. Universal Shank
5	150	130	19	0,90	1	24	10	JS922AF-5



Cuts thin sheet metal (0,7~3mm), fine pipe and profiles (diameter <100mm).
Effortless fine cuts.

JS1122AF



METAL MILLED & WAVY SET TEETH **EASY CUT** **FINE CUT** **LONG LIFE** **BIM 8% Co**

PACK Quantity	L mm	I mm	H mm	K mm	TS mm	TPI		ORDER NO. Universal Shank
5	225	205	19	0,90	1	24	10	JS1122AF-5



Cuts thin sheet metal (0,7~3mm), fine pipe and profiles (diameter <175mm).
Effortless fine cuts.

Sabre Saw Blades

JS641HM HW TOOTH

SPECIAL EXTRA LONG LIFE EASY CUT FINE CUT EXTRA LONG LIFE HW



PACK Quantity	L mm	I mm	H mm	K mm	TS mm	TPI		ORDER NO. Universal Shank
2	150	130	19	1,25	4,3	6	25	JS641HM-2

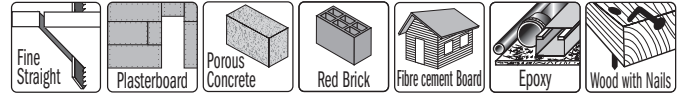

Cuts porous concrete, red brick, fibre cement, plasterboard, fibre-rienced plastic and epoxy (<100mm), wood & nails, ETERNIT®, MDF.

JS1141HM HW TOOTH

SPECIAL EXTRA LONG LIFE FAST CUT HW



PACK Quantity	L mm	I mm	H mm	K mm	TS mm	TPI		ORDER NO. Universal Shank
2	225	205	22	1,2	8,5	3	25	JS1141HM-2

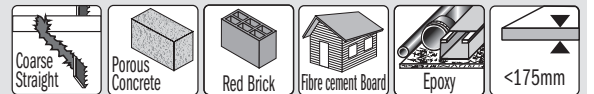

For cutting porous concrete, red brick, fibre cement (10-175mm), glass fibre-reinforced plastic/epoxy (<100mm). Fast Cut.

JS1241HM HW TOOTH

SPECIAL EXTRA LONG LIFE FAST CUT HW



PACK Quantity	L mm	I mm	H mm	K mm	TS mm	TPI		ORDER NO. Universal Shank
2	300	280	22	1,5	8,5	3	25	JS1241HM-2

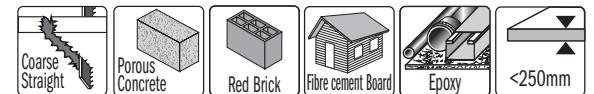

For cutting porous concrete, red brick, fibre cement (10-250mm), glass fibre-reinforced plastic/epoxy (<100mm). Fast Cut.

JS1243HM HW TOOTH

SPECIAL LONG LIFE FAST CUT HW

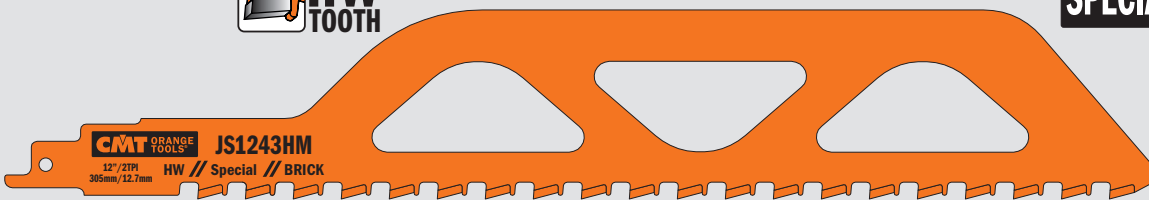

PACK Quantity	L mm	I mm	H mm	K mm	TS mm	TPI		ORDER NO. Universal Shank
1	305	250	50	1,50	12,7	2	25	JS1243HM

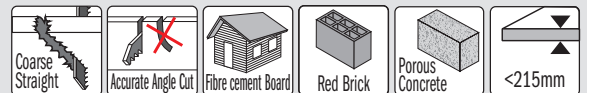

Cuts medium-sized brick up to 215mm in thickness.

JS2243HM HW TOOTH

SPECIAL LONG LIFE FAST CUT HW

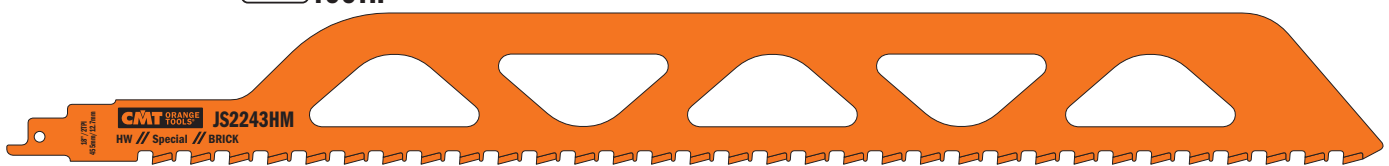

PACK Quantity	L mm	I mm	H mm	K mm	TS mm	TPI		ORDER NO. Universal Shank
1	455	400	50	1,50	12,7	2	25	JS2243HM

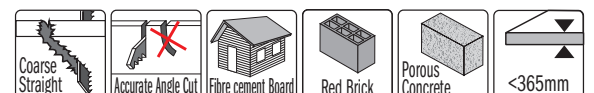

Cuts large brick up to 365mm in thickness.

Sabre Saw Blades

JS1113AWP-2

new

SPECIAL GROUND & KNIFE-EDGE **CLEAN CUT** **PRECISION CUT** **HCS**



PACK Quantity	L mm	I mm	H mm	K mm	TS mm		ORDER NO.
2	228	208	22	1,5	5		25 JS1113AWP-2

For cutting polystyrene and fibre insulation (<175mm). Clean and precision cut.

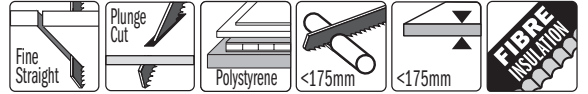

JS1213AWP

new

SPECIAL GROUND & KNIFE-EDGE **CLEAN CUT** **PRECISION CUT** **HCS**



PACK Quantity	L mm	I mm	H mm	K mm	TS mm		ORDER NO.
1	300	280	22	1,5	5		25 JS1213AWP

For cutting polystyrene and fibre insulation (<250mm). Clean and precision cut.

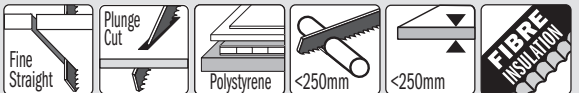

JS2013AWP

new

SPECIAL GROUND & KNIFE-EDGE **CLEAN CUT** **PRECISION CUT** **HCS**

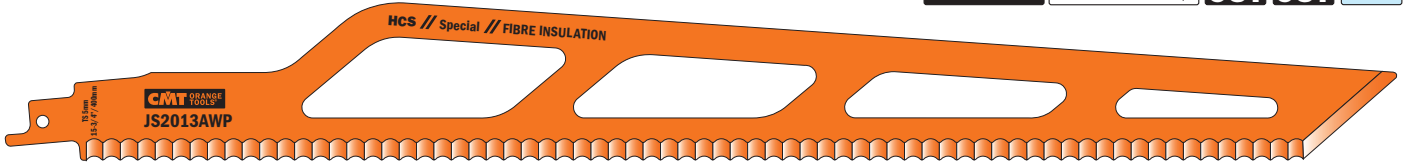

PACK Quantity	L mm	I mm	H mm	K mm	TS mm		ORDER NO.
1	400	380	45	1,5	5		25 JS2013AWP

For cutting polystyrene and fibre insulation (<300mm). Clean and precision cut.

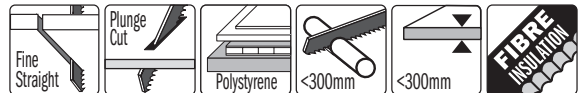

JS1211K

SPECIAL **FAST CUT** **INOX**



PACK Quantity	L mm	I mm	H mm	K mm	TS mm	TPI	ORDER NO.
5	300	275	19	1,2	8,5	3	10 JS1211K-5

Ideal for sectioning and cutting meat, bone, frozen products and ice up to 250mm in thickness.



25 Piece Reciprocating Saw Blade Set

JS025

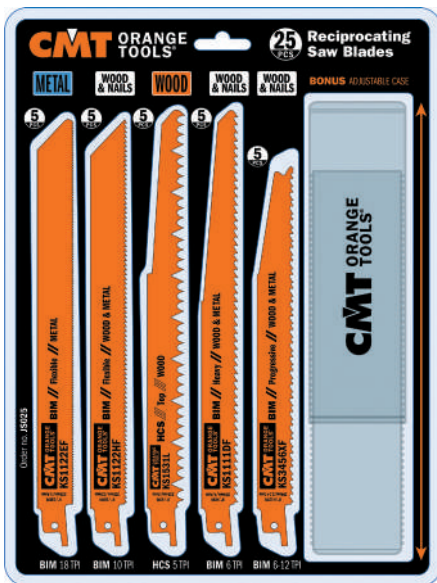

5 PCS	KS1122EF BIM	METAL	TPI 18 1.4mm	Fine Straight	Sheet Metal	Flush cut	Pipes, profiles	<175mm	<1.5-4mm <1/16"-3/32"	LONG LIFE
5 PCS	KS1122HF BIM	WOOD & NAILS	TPI 10 2.5mm	Wood with nails	Sheet Metal	Flush cut	Pallets	Pipes	<175mm <7/8"	LONG LIFE
5 PCS	KS1531L HCS	WOOD	TPI 5 5mm	Coarse Straight	Nail-free coarse wood	Pruning		<190mm <1-1/2"	FAST CUT	
5 PCS	KS1111DF BIM	WOOD & NAILS	TPI 6 4.3mm	Wood with nails	Boards	Plastic	Epoxy	<175mm <7/8"	EASY CUT	LONG LIFE
5 PCS	KS3456XF BIM	WOOD & NAILS	TPI 6-12 2.1-4.3mm	Wood with nails	Boards	Sheet Metal	Epoxy	THIN & THICK <150mm <7/8"	LONG LIFE	

Minimum 10 pieces or multiple

Handle for Reciprocating Saw

Handle for reciprocating saw blades with 12,7mm (1/2") universal shank.
Practical, functional, ergonomic and featuring non-slip material.
Screw for mechanical fastening.

JS001



Minimum 10 pieces or multiple

DESCRIPTION	ORDER NO.
Handle for reciprocating saw	JS001

TOOLS FOR MULTI-CUTTERS



PRODUCTS	PAGE
STARLOCK®/STARLOCKPLUS®/STARLOCKMAX® Arbors	
Radial Saw Blades for Multi-Mat & Wood&Metal	109
Plunge Cut & Precision for Wood	110~112
Plunge Cut for Wood&Nails	112~115
Blades for Wood&Metal	113-114
Blades for Metal	115
Blades for Masonry	116
Rasp & Saw for Masonry	117
Scraper for Multi-Mat	118
Blades for Special Materials	119
Sets for Multi-Cutters	119
Delta Sanding Pad	120
Polishing Fleece	120
Sandpaper Sheet	120

Universal/SuperCut Arbors

Plunge Cut & Precision for Wood	112-123
Radial Saw Blade for Wood	124
Plunge & Flush-Cut for Wood&Metal	124~126
Radial Saw Blade for Wood&Metal	126
Scraper for Multi-Mat	127
Radial Saw Blade for Masonry	127-128
Rasp & Saw for Masonry	128-129
Delta Sanding Pad	129
Sets for Multi-Cutters	130

CMT11

Oscillating Multi-Tool



395



MAXIMIZE YOUR PERFORMANCE!



HIGH CARBON STEEL
for cutting wood and plastic.



BI-METAL WITH 8% COBALT
for cutting metal, nail embedded wood and plastic.



BI-METAL WITH 8% COBALT WITH TITANIUM COATING
for cutting metal, nail embedded wood and plastic, providing extreme performance and 30% longer lifetime.



TUNGSTEN CARBIDE TIPPED
for cutting wood, screws and nails, fiber cement board, plasterboard, plastic, sheet metal, copper, aluminium and stainless steel. Doubles tool lifetime.



TUNGSTEN CARBIDE GRIT COATED
for routing joints and grooves, smaller cutouts, and routing recesses in a variety of materials: tiles, plasterboard, porous concrete, construction materials, epoxy and fiberglass.



DIAMOND GRIT COATED
for routing joints and grooves, smaller cutouts, and routing recesses in a variety of materials: tiles, plasterboard, porous concrete, construction materials, epoxy and fiberglass. Extreme performance and longer lifetime.

SAWING & CUTTING



CUTTING & SCRAPING



GRINDING, RASPING & SEPARATING



SANDING & POLISHING



TOOTH CHARACTERISTICS

HW Tungsten Carbide Tipped

HCS High Carbon Steel

HSS High Speed Steel

HL High-Alloyed Tool Steel

BIM TiN Bimetal with 8% Cobalt + TiN Coated Teeth

BIM 8% Co Bimetal with 8% Cobalt

GRIT Diamond Grit

CARBIDE GRIT Carbide Grit

CARBIDE TiN Carbide TiN

MATERIALS



APPLICATIONS

- GRINDING
- SAWING
- JOINT CLEANING
- PLASTIC CUTTING
- CARPET REMOVAL
- PLUNGE CUTTING
- WOOD CUTTING
- CUTTING LAMINATE SHEETS
- TUBE TRIMMING
- NAIL CUTTING

THE RIGHT BLADE FOR THE BEST RESULTS!

Quick reference charts and pictograms help you choose the right blade for your application.



STARLOCK®: THE NEW SYSTEM FOR MULTI-CUTTER POWER TOOLS

STARLOCK® enables extremely reliable and fast accessory changes in a record time of less than 3 seconds. It also guarantees a secure fit and therefore maximum power transfer. The result: up to around 35% faster performance depending on the accessory, noticeably improved precision and reduced noise. To protect the individual tools from overload and damage, the system is divided into 3 performance classes: **STARLOCK®**, **STARLOCKPLUS®** and **STARLOCKMAX®**. The performance potential of a multi-cutter tool can only be fully exploited with the right accessories.

The exceptional quality and service life of our accessories combined with the perfect results delivers excellent value for money.

POWERTOOL COMPATIBILITY CHART FOR CMT MULTI-CUTTER ACCESSORIES	STARLOCK	STARLOCK PLUS	STARLOCK MAX
	SL	SLP	SLM
AEG®	●		
BOSCH®	●	●	●
CMT®	●		
CRAFTSMAN®	●	●	
DEWALT®	●		
DREMEL®	●		
EINHELL®	●		
FEIN® MULTITALENT®/MULTIMASTER®	●	●	
FEIN® SUPERCUT AUTOMOTIVE/CONSTRUCTION	●	●	●
FESTOOL® VECTURO®	●	●	●
HITACHI®	●		
MAKITA®	●	●	
METABO®	●		
MILWAUKEE®	●	●	
RIDGID®	●		
ROCKWELL®	●	●	
RYOBI®	●	●	
SKIL®	●	●	
WORX®	●		

Some brands may require an adaptor

OMF113 STARLOCK

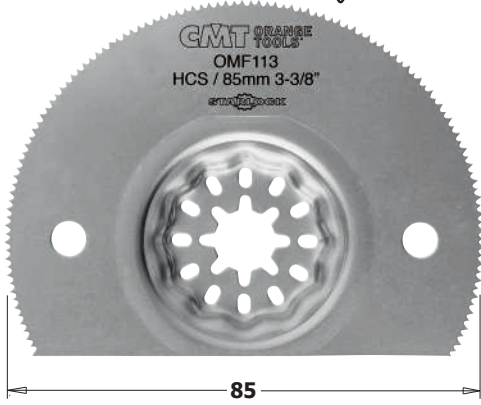

85mm RADIAL SAW BLADE FOR SOFT MATERIALS, SEGMENTED

MULTI-MATERIALS

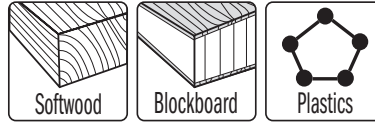

PACK Quantity	W mm	K mm	TS mm	TPI		ORDER NO. STARLOCK®
1 in Clamshell	85	0,8	1,5	17	100	OMF113-X1
5 in Clamshell	85	0,8	1,5	17	15	OMF113-X5

OMF106 STARLOCK



85mm RADIAL SAW BLADE FOR WOOD & METAL, SEGMENTED

WOOD&METAL

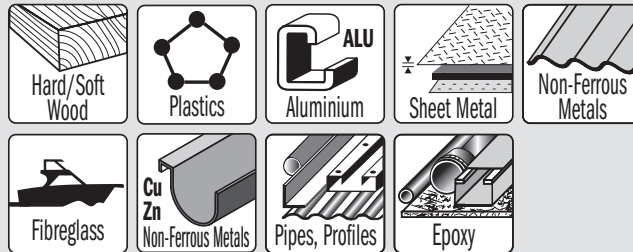

PACK Quantity	W mm	K mm	TS mm	TPI		ORDER NO. STARLOCK®
1 in Clamshell	85	0,7	1,34	19	100	OMF106-X1
5 in Clamshell	85	0,7	1,34	19	50	OMF106-X5

OMF174 STARLOCK



85mm CIRCULAR SAW BLADE FOR WOOD & METAL

WOOD&METAL

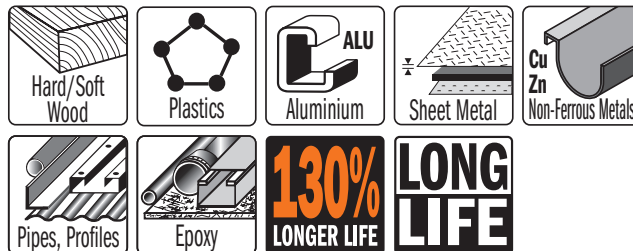

PACK Quantity	W mm	K mm	TS mm	TPI		ORDER NO. STARLOCK®
1 in Clamshell	85	0,7	1,27	20	100	OMF174-X1
5 in Clamshell	85	0,7	1,27	20	50	OMF174-X5

Cutting Accessories for Multi-Cutters

OMF133 STARLOCK

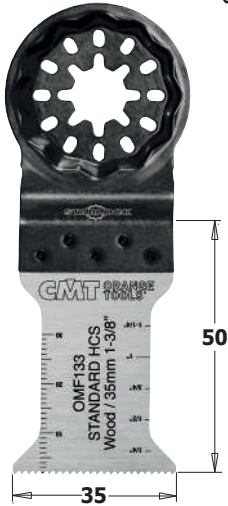

35mm PLUNGE CUT BLADE FOR WOOD

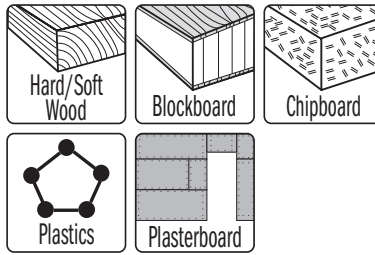

WOOD

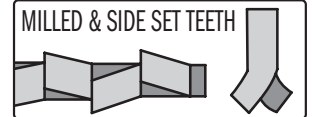

PACK Quantity	W mm	I mm	TS mm	TPI		ORDER NO. STARLOCK®
1 in Clamshell	35	50	1,4	18	70	OMF133-X1
5 in Clamshell	35	50	1,4	18	34	OMF133-X5
50 in Bulk Pack	35	50	1,4	18	8	OMF133-X50

OMF126 STARLOCK



35mm PRECISION CUT BLADE WITH JAPANESE TOOTHING FOR WOOD

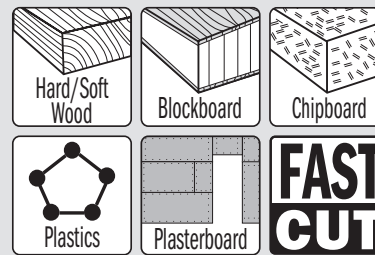

WOOD

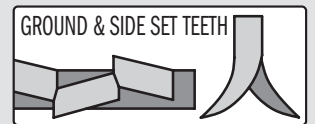

PACK Quantity	W mm	I mm	TS mm	TPI		ORDER NO. STARLOCK®
1 in Clamshell	35	50	1,75	14	70	OMF126-X1
5 in Clamshell	35	50	1,75	14	34	OMF126-X5
50 in Bulk Pack	35	50	1,75	14	8	OMF126-X50



JAPANESE TOOTHING

OMF233 STARLOCK

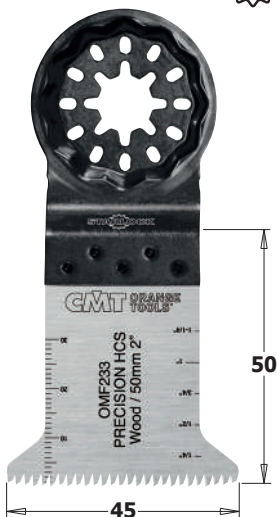

45mm PRECISION CUT BLADE WITH JAPANESE TOOTHING FOR WOOD

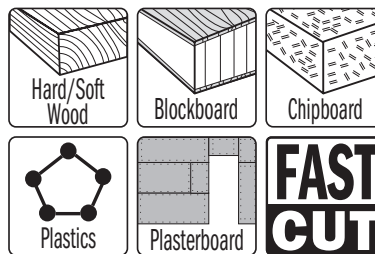

WOOD

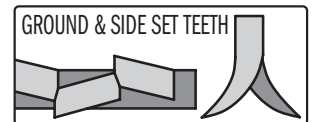

PACK Quantity	W mm	I mm	TS mm	TPI		ORDER NO. STARLOCK®
1 in Clamshell	45	50	1,75	14	70	OMF233-X1
5 in Clamshell	45	50	1,75	14	34	OMF233-X5
50 in Bulk Pack	45	50	1,75	14	8	OMF233-X50



JAPANESE TOOTHING

OMF230 STARLOCK

65mm PRECISION CUT BLADE WITH JAPANESE TOOTHING FOR WOOD

WOOD

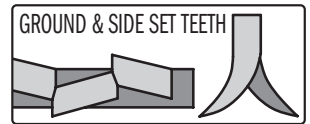
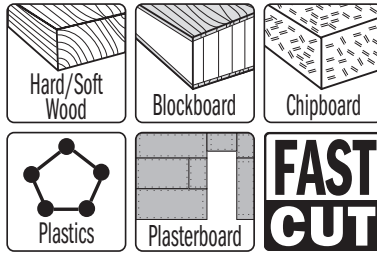

PACK Quantity	W mm	I mm	TS mm	TPI		ORDER NO. STARLOCK®
1 in Clamshell	65	50	1,75	14	70	OMF230-X1
5 in Clamshell	65	50	1,75	14	34	OMF230-X5
50 in Bulk Pack	65	50	1,75	14	8	OMF230-X50



JAPANESE TOOTHING

OMF205 STARLOCK

35mm PRECISION CUT BLADE WITH JAPANESE TOOTHING FOR WOOD

WOOD

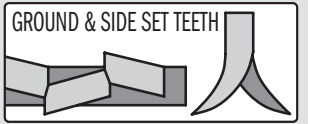
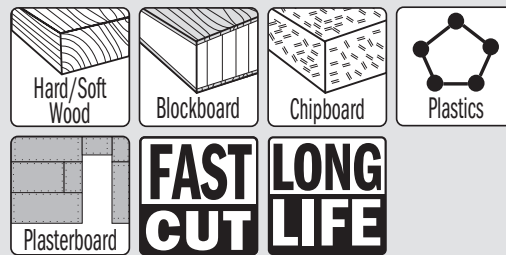
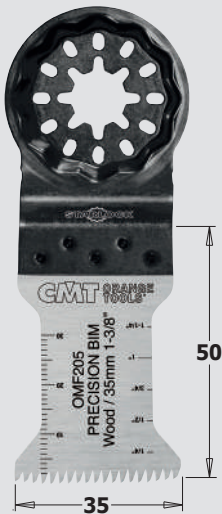

PACK Quantity	W mm	I mm	TS mm	TPI		ORDER NO. STARLOCK®
1 in Clamshell	35	50	1,75	14	70	OMF205-X1
5 in Clamshell	35	50	1,75	14	34	OMF205-X5
50 in Bulk Pack	35	50	1,75	14	8	OMF205-X50



JAPANESE TOOTHING
Reduced tooth height for longer lifetime

OMF232 STARLOCK

45mm PRECISION CUT BLADE WITH JAPANESE TOOTHING FOR WOOD

WOOD

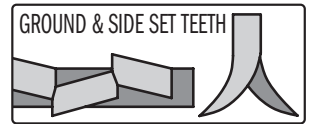
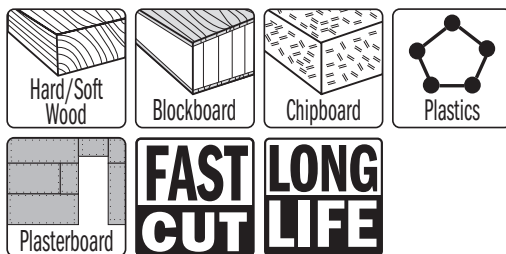
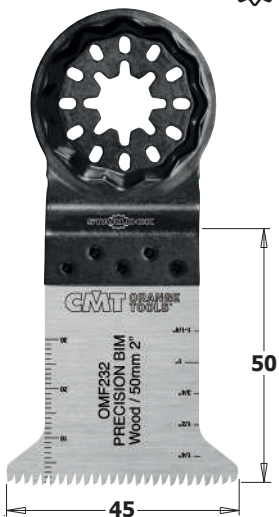

PACK Quantity	W mm	I mm	TS mm	TPI		ORDER NO. STARLOCK®
1 in Clamshell	45	50	1,75	14	70	OMF232-X1
5 in Clamshell	45	50	1,75	14	34	OMF232-X5
50 in Bulk Pack	45	50	1,75	14	8	OMF232-X50



JAPANESE TOOTHING
Reduced tooth height for longer lifetime

Cutting Accessories for Multi-Cutters

OMF229 STARLOCK

65mm PRECISION CUT BLADE WITH JAPANESE TOOTHING FOR WOOD

WOOD

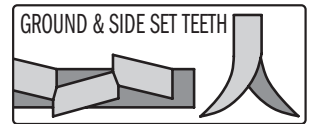
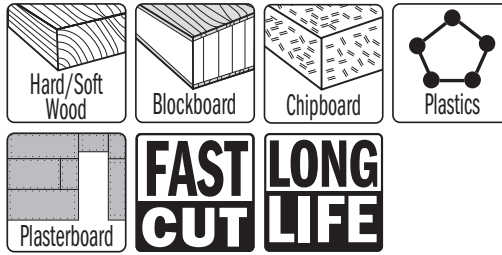

BIM
8% Co

PACK Quantity	W mm	I mm	TS mm	TPI		ORDER NO. STARLOCK®
1 in Clamshell	65	50	1,75	14	70	OMF229-X1
5 in Clamshell	65	50	1,75	14	34	OMF229-X5
50 in Bulk Pack	65	50	1,75	14	8	OMF229-X50



JAPANESE TOOTHING
Reduced tooth height for longer lifetime

OMF208 STARLOCK PLUS

65mm PRECISION CUT BLADE WITH JAPANESE TOOTHING FOR WOOD

WOOD

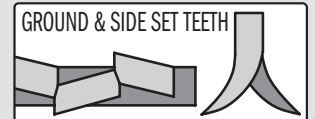
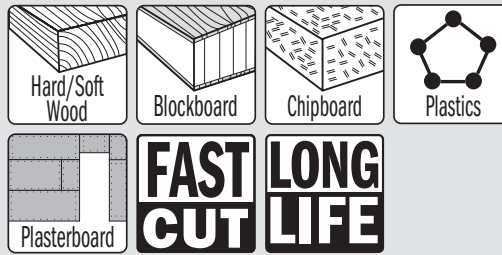

BIM
8% Co

PACK Quantity	W mm	I mm	TS mm	TPI		ORDER NO. STARLOCKPLUS®
1 in Clamshell	65	50	1,75	14	70	OMF208-X1
5 in Clamshell	65	50	1,75	14	34	OMF208-X5
50 in Bulk Pack	65	50	1,75	14	8	OMF208-X50

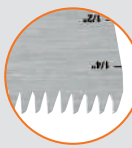

JAPANESE TOOTHING
Reduced tooth height for longer lifetime

OMF184 STARLOCK

10mm PLUNGE CUT BLADE FOR WOOD & NAILS

WOOD&NAILS

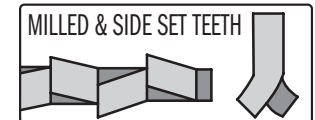

BIM
8% Co

PACK Quantity	W mm	I mm	TS mm	TPI		ORDER NO. STARLOCK®
1 in Clamshell	10	30	1,4	18	70	OMF184-X1
5 in Clamshell	10	30	1,4	18	34	OMF184-X5
50 in Bulk Pack	10	30	1,4	18	8	OMF184-X50

OMF183 STARLOCK 20mm PLUNGE CUT BLADE FOR WOOD & NAILS

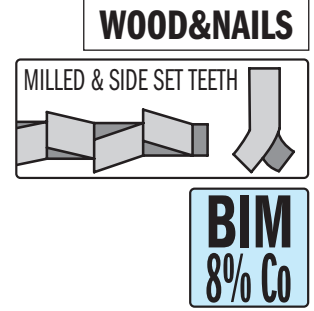

PACK Quantity	W mm	I mm	TS mm	TPI		ORDER NO. STARLOCK®
1 in Clamshell	20	34	1,4	18	70	OMF183-X1
5 in Clamshell	20	34	1,4	18	34	OMF183-X5
50 in Bulk Pack	20	34	1,4	18	8	OMF183-X50

OMF222 STARLOCK 28mm PLUNGE CUT BLADE FOR WOOD & METAL

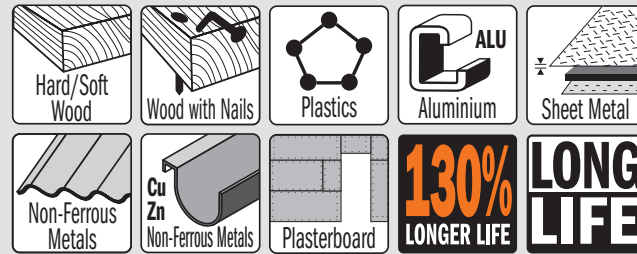

PACK Quantity	W mm	I mm	TS mm	TPI		ORDER NO. STARLOCK®
1 in Clamshell	28	55	1,4	18	70	OMF222-X1
5 in Clamshell	28	55	1,4	18	34	OMF222-X5
50 in Bulk Pack	28	55	1,4	18	8	OMF222-X50

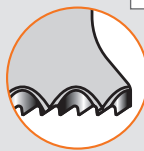

WAVY UNIVERSAL TOOTHING

OMF160 STARLOCK 35mm PLUNGE CUT BLADE FOR WOOD & NAILS

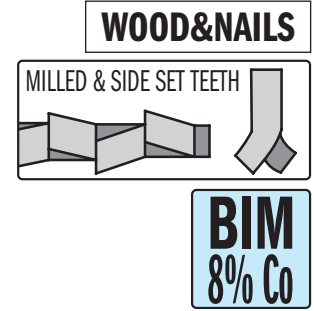

PACK Quantity	W mm	I mm	TS mm	TPI		ORDER NO. STARLOCK®
1 in Clamshell	35	50	1,4	18	70	OMF160-X1
5 in Clamshell	35	50	1,4	18	34	OMF160-X5
50 in Bulk Pack	35	50	1,4	18	8	OMF160-X50



Watch the video on



OMF223 STARLOCK

44mm PLUNGE CUT BLADE FOR WOOD & METAL

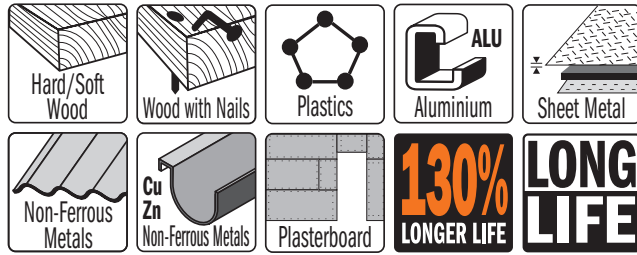

WOOD&METAL

MILLED & WAVY SET TEETH

BIM 8% Co

PACK Quantity	W mm	I mm	TS mm	TPI		ORDER NO. STARLOCK®
1 in Clamshell	44	55	1,4	18	70	OMF223-X1
5 in Clamshell	44	55	1,4	18	34	OMF223-X5
50 in Bulk Pack	44	55	1,4	18	8	OMF223-X50



WAVY UNIVERSAL TOOTHING

OMF221 STARLOCK

50mm PLUNGE CUT BLADE FOR WOOD & NAILS

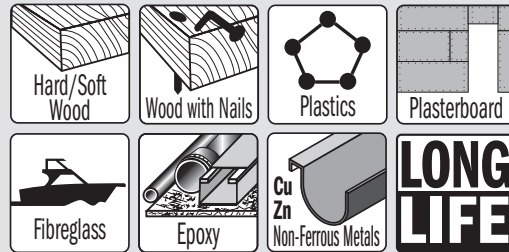

WOOD&NAILS

MILLED & SIDE SET TEETH

BIM 8% Co

PACK Quantity	W mm	I mm	TS mm	TPI		ORDER NO. STARLOCK®
1 in Clamshell	50	50	1,4	18	70	OMF221-X1
5 in Clamshell	50	50	1,4	18	34	OMF221-X5
50 in Bulk Pack	50	50	1,4	18	8	OMF221-X50

OMF228 STARLOCK

65mm PLUNGE CUT BLADE FOR WOOD & NAILS

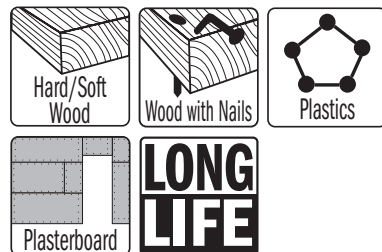

WOOD&NAILS

MILLED & SIDE SET TEETH

BIM 8% Co

PACK Quantity	W mm	I mm	TS mm	TPI		ORDER NO. STARLOCK®
1 in Clamshell	65	50	1,4	18	70	OMF228-X1
5 in Clamshell	65	50	1,4	18	34	OMF228-X5
50 in Bulk Pack	65	50	1,4	18	8	OMF228-X50

OMF161 STARLOCK PLUS 65mm PLUNGE CUT BLADE FOR WOOD & NAILS

WOOD&NAILS

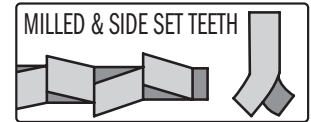
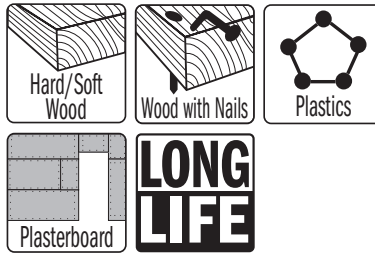
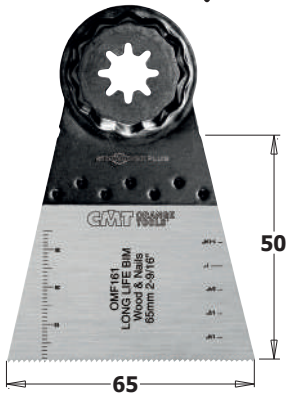

BIM 8% Co

PACK Quantity	W mm	I mm	TS mm	TPI		ORDER NO. STARLOCKPLUS®
1 in Clamshell	65	50	1,4	18	70	OMF161-X1
5 in Clamshell	65	50	1,4	18	34	OMF161-X5
50 in Bulk Pack	65	50	1,4	18	8	OMF161-X50

OMF157 STARLOCK

30mm PLUNGE CUT BLADE FOR METAL

METAL

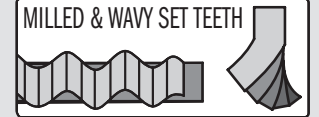
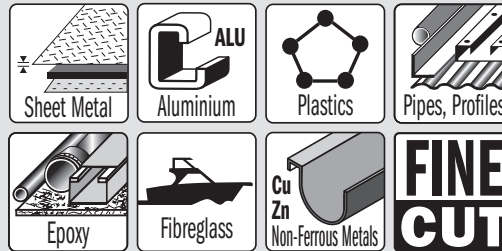

BIM 8% Co

PACK Quantity	W mm	I mm	TS mm	TPI		ORDER NO. STARLOCK®
1 in Clamshell	30	50	1,2	21	70	OMF157-X1
5 in Clamshell	30	50	1,2	21	34	OMF157-X5
50 in Bulk Pack	30	50	1,2	21	8	OMF157-X50

OMF237 STARLOCK PLUS 32mm CARBIDE + TIN COATING PLUNGE & FLUSH-CUT FOR METAL

METAL

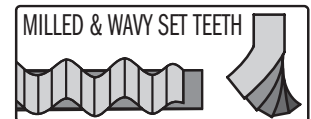
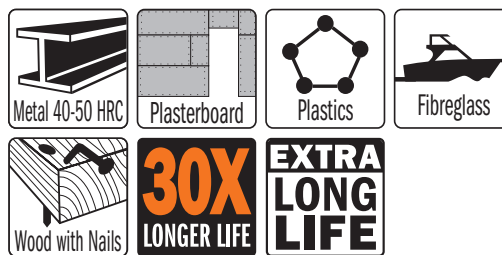
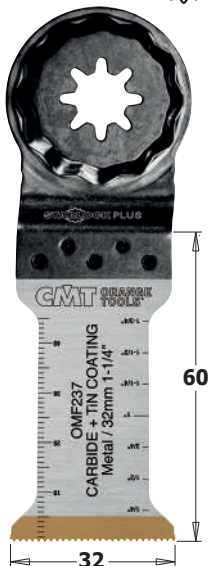

CARBIDE TiN

PACK Quantity	W mm	I mm	TS mm	TPI		ORDER NO. STARLOCKPLUS®
1 in Clamshell	32	60	1,2	21	70	OMF237-X1
50 in Bulk Pack	32	60	1,2	21	8	OMF237-X50

OMF118 STARLOCK

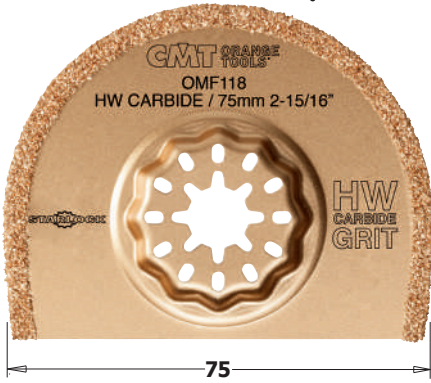

75mm CARBIDE GRIT RADIAL SAW BLADE, SEGMENTED

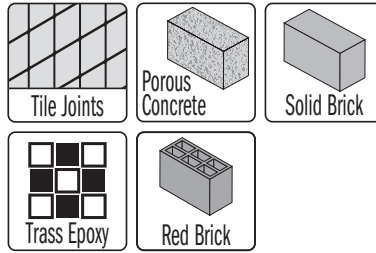

MASONRY



PACK Quantity	W mm	K mm		ORDER NO. STARLOCK®
1 in Clamshell	75	2,2	80	OMF118-X1
5 in Clamshell	75	2,2	40	OMF118-X5

OMF125 STARLOCK



75mm CARBIDE GRIT RADIAL SAW BLADE, SEGMENTED

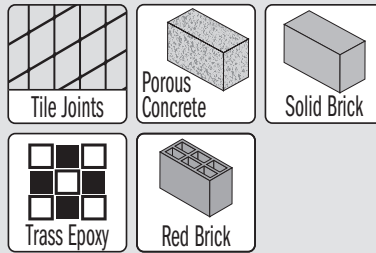

MASONRY



PACK Quantity	W mm	K mm		ORDER NO. STARLOCK®
1 in Clamshell	75	1,2	100	OMF125-X1
5 in Clamshell	75	1,2	40	OMF125-X5

OMF114 STARLOCK



75mm DIAMOND COATED RADIAL SAW BLADE, SEGMENTED

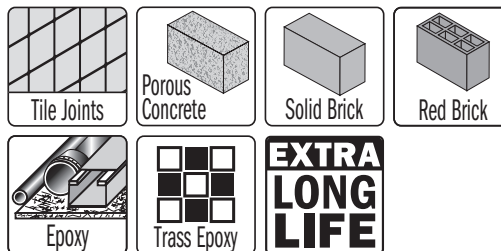

MASONRY



PACK Quantity	W mm	K mm		ORDER NO. STARLOCK®
1 in Clamshell	75	2,2	115	OMF114-X1
5 in Clamshell	75	2,2	56	OMF114-X5

OMF002 STARLOCK PLUS

45mm CARBIDE GRIT FINGERTIP RASP, DOUBLE-SIDED

MASONRY

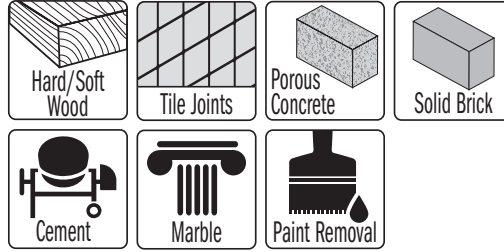

PACK Quantity	W mm	I mm		ORDER NO. STARLOCKPLUS®
1 in Clamshell	33	45	250	OMF002-X1

OMF001 STARLOCK

80mm CARBIDE GRIT DELTA RASP

MASONRY

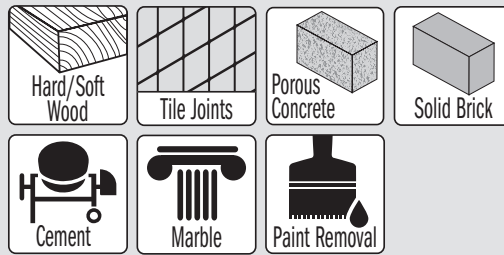
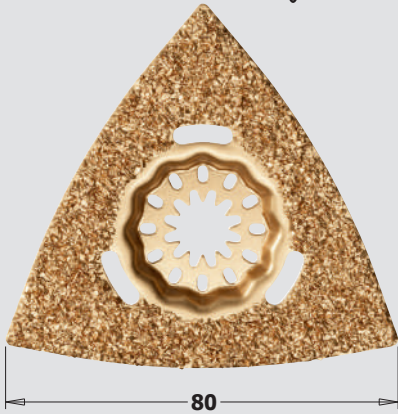

PACK Quantity	W mm		ORDER NO. STARLOCK®
1 in Clamshell	80	250	OMF001-X1

OMF243 STARLOCK MAX

60mm DIAMOND COATED SAW BLADE, SEGMENTED

MASONRY

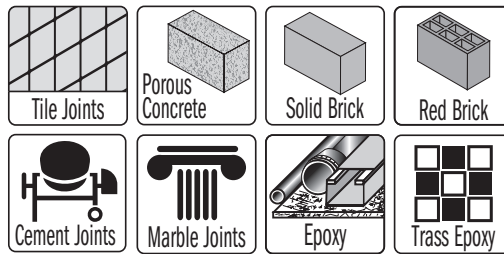

EXTRA LONG LIFE

PACK Quantity	W mm	K mm		ORDER NO. STARLOCKMAX®
1 in Clamshell	60	2,2	115	OMF243-X1

OMF226 STARLOCK

52mm RIGID SCRAPER BLADE FOR ALL MATERIALS

MULTI-MATERIALS

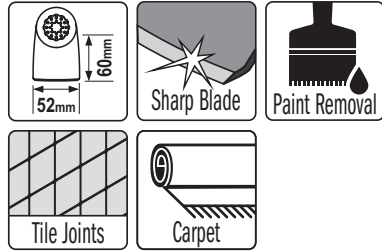

PACK Quantity	W mm	K mm		ORDER NO. STARLOCK®
1 in Clamshell	52	0,8	100	OMF226-X1

OMF165 STARLOCK

52mm FLEXIBLE SCRAPER BLADE FOR ALL MATERIALS

MULTI-MATERIALS

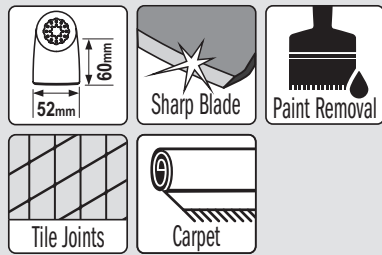

PACK Quantity	W mm	K mm		ORDER NO. STARLOCK®
1 in Clamshell	52	0,4	100	OMF165-X1

OMF245 STARLOCK

70mm "MUSHROOM-SHAPED" CUTTING BLADE FOR ALL MATERIALS

MULTI-MATERIALS

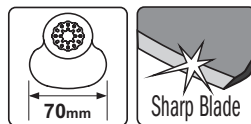

PACK Quantity	W mm	K mm		ORDER NO. STARLOCK®
5 in Clamshell	70	0,4	50	OMF245-X5

OMF201 STARLOCK PLUS

4mm ANGLED GOUGING BLADE

SPECIAL

HCS



PACK Quantity	K mm	W mm	I mm		ORDER NO. STARLOCKPLUS®
1 in Clamshell	4	16	11	70	OMF201-X1

OMF251 STARLOCK

41mm MULTI-KNIFE WITH THREE CUTTING EDGES, SEGMENTED

SPECIAL

HCS

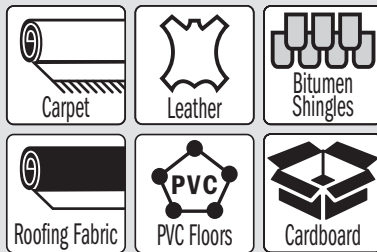
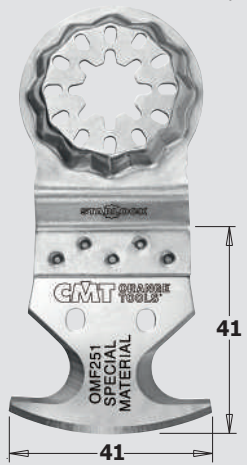

PACK Quantity	W mm	I mm		ORDER NO. STARLOCK®
1 in Clamshell	41	41	70	OMF251-X1

OMF-X4 STARLOCK

4 PIECE GENERAL PURPOSE SET FOR MULTI-CUTTERS

**WOOD
WOOD&NAILS**

- 2 blades with Japanese Tothing for all wood products, blockboard, plasterboard and plastics.
- 2 blades in BIM for all wood products, blockboard, plasterboard, fiberglass, epoxy resin and soft plastics. Excellent for cutting wood with embedded nails up to 5mm in diameter and even masonry, like porous concrete.



8 Sets in End-cap display (minimum 8 pieces or multiple)



PACK Quantity	MATERIAL	W mm	I mm	TS mm	TPI	ORDER NO.
1	HCS	35	50	1,75	14	OMF126-X1
1	BIM	35	50	1,4	18	OMF160-X1
1	BIM	50	50	1,4	18	OMF221-X1
1	HCS	65	50	1,75	14	OMF230-X1

OMF136 STARLOCK

93mm DELTA SANDING PAD. PERFORATED

MULTI-MATERIALS



PACK Quantity	W mm		ORDER NO. STARLOCK®
1 in Clamshell	93	40	OMF136-X1

OMA30000

93mm DELTA POLISHING FLEECE. PERFORATED

MULTI-MATERIALS

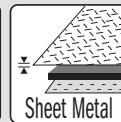

PACK Quantity	W mm		ORDER NO.
4 in Clamshell	93	10	OMA30000-X4

OMA30

93MM ALUMINIUM-OXIDE DELTA SANDPAPER FOR WOOD. PERFORATED

WOOD

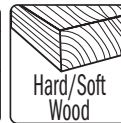
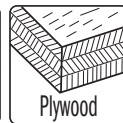
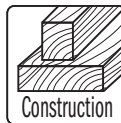

PACK Quantity	W mm	GRIT		ORDER NO.
10 in Clamshell	93	40	10	OMA30040-X10
10 in Clamshell	93	60	10	OMA30060-X10
10 in Clamshell	93	80	10	OMA30080-X10
10 in Clamshell	93	100	10	OMA30100-X10
10 in Clamshell	93	120	10	OMA30120-X10
10 in Clamshell	93	180	10	OMA30180-X10
10 in Clamshell	93	240	10	OMA30240-X10

THE RIGHT BLADE FOR THE BEST RESULTS!

Quick reference charts and pictograms help you choose the right blade for your application.

WOOD



WOOD&METAL



MULTI-MATERIALS



MASONRY



CMT UNIVERSAL ARBOR FITS MOST MULTI-CUTTERS ON THE MARKET

This tool mount also enables the accessory to be repositioned in 30-degree steps.

ARBOR FOR FEIN® SUPERCUT AND FESTOOL® VECTURO®

This tool mount also enables the accessory to be repositioned in 30-degree steps.

OMA31



Universal Adaptors

This universal adaptor permits easy attachment of CMT accessories to most multi-cutter tools. Fits snugly and does not slip. Ideal for BOSCH®, CHICAGO®, CRAFTSMAN®, DREMEL®, FEIN®, MAKITA®, MILWAUKEE®, MASTERCRAFT®, OZITO®, AEG®, RIDGID®, ROCKWELL®, SMART®, WORX®.

PACK Quantity	ORDER NO.
2 in Clamshell	OMA31-X2

Accessories for Multi-Cutters

OMM01 OMS01

Universal Arbor



Arbor for
FEIN® SuperCut
FESTOOL® VECTURO®



10mm PLUNGE & FLUSH-CUT BLADE FOR WOOD

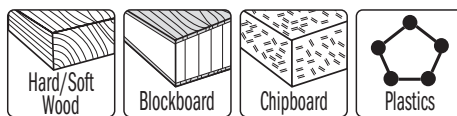

WOOD

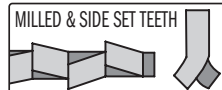

PACK Quantity	W mm	I mm	TPI		ORDER NO. Universal Arbor	ORDER NO. Arbor for FEIN® Supercut
1 in Clamshell	10	28	18	10	OMM01-X1	OMS01-X1

OMM02 OMS02

Universal Arbor



Arbor for
FEIN® SuperCut
FESTOOL® VECTURO®



22mm PLUNGE & FLUSH-CUT BLADE FOR WOOD

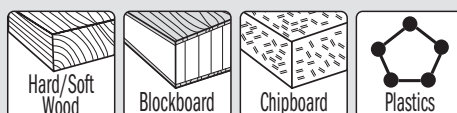

WOOD

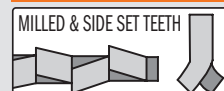

PACK Quantity	W mm	I mm	TPI		ORDER NO. Universal Arbor	ORDER NO. Arbor for FEIN® Supercut
1 in Clamshell	22	48	18	10	OMM02-X1	OMS02-X1
5 in Clamshell	22	48	18	5	OMM02-X5	OMS02-X5

OMM03 OMS03

Universal Arbor

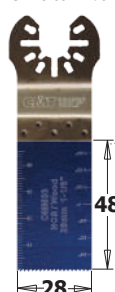

Arbor for
FEIN® SuperCut
FESTOOL® VECTURO®



28mm PLUNGE & FLUSH-CUT BLADE FOR WOOD

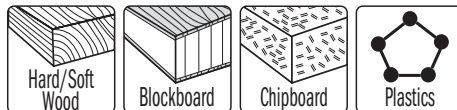

WOOD

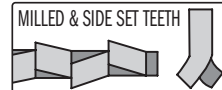

PACK Quantity	W mm	I mm	TPI		ORDER NO. Universal Arbor	ORDER NO. Arbor for FEIN® Supercut
1 in Clamshell	28	48	18	10	OMM03-X1	OMS03-X1
50 in Bulk Pack	28	48	18	2	OMM03-X50	OMS03-X50

OMM04 OMS04

Universal Arbor



Arbor for
FEIN® SuperCut
FESTOOL® VECTURO®



34mm PRECISION CUT BLADE - JAPANESE TOOTHING FOR WOOD

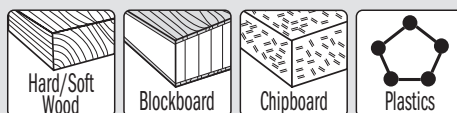

WOOD



PACK Quantity	W mm	I mm	TPI		ORDER NO. Universal Arbor	ORDER NO. Arbor for FEIN® Supercut
1 in Clamshell	34	40	14	10	OMM04-X1	OMS04-X1
5 in Clamshell	34	40	14	5	OMM04-X5	OMS04-X5
50 in Bulk Pack	34	40	14	2	OMM04-X50	OMS04-X50

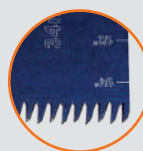

JAPANESE TOOTHING



OMM05

Universal Arbor

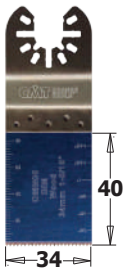

OMS05

Arbor for
FEIN® SuperCut
FESTOOL® VECTURO®



34mm PLUNGE & FLUSH-CUT BLADE FOR WOOD

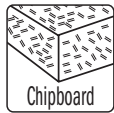
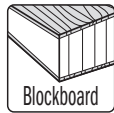

WOOD

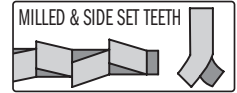

PACK Quantity	W mm	I mm	TPI		ORDER NO. Universal Arbor	ORDER NO. Arbor for FEIN® Supercut
1 in Clamshell	34	40	18	10	OMM05-X1	OMS05-X1
5 in Clamshell	34	40	18	5	OMM05-X5	OMS05-X5
50 in Bulk Pack	34	40	18	2	OMM05-X50	OMS05-X50

OMM36

Universal Arbor

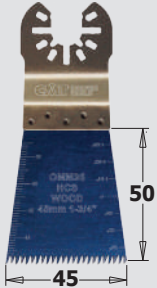

OMS36

Arbor for
FEIN® SuperCut
FESTOOL® VECTURO®



45mm PRECISION CUT BLADE - JAPANESE TOOTHING FOR WOOD

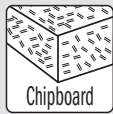
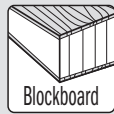

WOOD

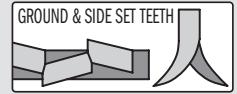

PACK Quantity	W mm	I mm	TPI		ORDER NO. Universal Arbor	ORDER NO. Arbor for FEIN® Supercut
5 in Clamshell	45	50	14	5	OMM36-X5	OMS36-X5
50 in Bulk Pack	45	50	14	2	OMM36-X50	OMS36-X50



JAPANESE TOOTHING

OMM06

Universal Arbor

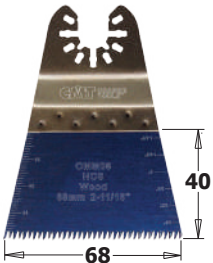

OMS06

Arbor for
FEIN® SuperCut
FESTOOL® VECTURO®



68mm PRECISION CUT BLADE - JAPANESE TOOTHING FOR WOOD

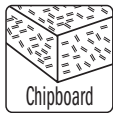
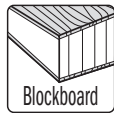

WOOD

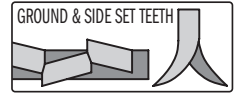

PACK Quantity	W mm	I mm	TPI		ORDER NO. Universal Arbor	ORDER NO. Arbor for FEIN® Supercut
1 in Clamshell	68	40	14	10	OMM06-X1	OMS06-X1
5 in Clamshell	68	40	14	5	OMM06-X5	OMS06-X5
50 in Bulk Pack	68	40	14	2	OMM06-X50	OMS06-X50

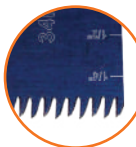

JAPANESE TOOTHING

OMM07

Universal Arbor

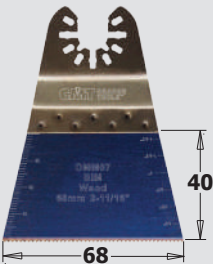

OMS07

Arbor for
FEIN® SuperCut
FESTOOL® VECTURO®



68mm PRECISION CUT BLADE - JAPANESE TOOTHING FOR WOOD

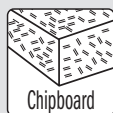
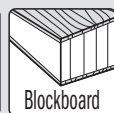

WOOD

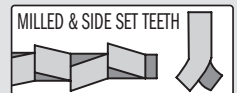

PACK Quantity	W mm	I mm	TPI		ORDER NO. Universal Arbor	ORDER NO. Arbor for FEIN® Supercut
1 in Clamshell	68	40	18	10	OMM07-X1	OMS07-X1
5 in Clamshell	68	40	18	5	OMM07-X5	OMS07-X5
50 in Bulk Pack	68	40	18	2	OMM07-X50	OMS07-X50

Accessories for Multi-Cutters

OMM08

Universal Arbor



OMS08

Arbor for
FEIN® SuperCut
FESTOOL® VECTURO®



87mm RADIAL SAW BLADE FOR WOOD, SEGMENTED

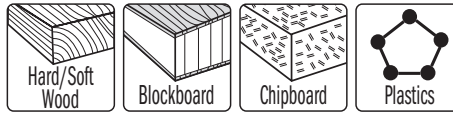

WOOD



PACK Quantity	W mm	TPI		ORDER NO. Universal Arbor	ORDER NO. Arbor for FEIN® SuperCut
1 in Clamshell	87	18	10	OMM08-X1	OMS08-X1

OMM09

Universal Arbor



OMS09

Arbor for
FEIN® SuperCut
FESTOOL® VECTURO®



10mm PLUNGE & FLUSH-CUT BLADE FOR WOOD & METAL



WOOD&METAL

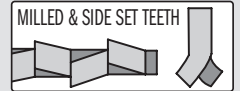

PACK Quantity	W mm	I mm	TPI		ORDER NO. Universal Arbor	ORDER NO. Arbor for FEIN® SuperCut
1 in Clamshell	10	28	18	10	OMM09-X1	OMS09-X1
5 in Clamshell	10	28	18	5	OMM09-X5	OMS09-X5
50 in Bulk Pack	10	28	18	2	OMM09-X50	OMS09-X50

OMM10

Universal Arbor



OMS10

Arbor for
FEIN® SuperCut
FESTOOL® VECTURO®



22mm PLUNGE & FLUSH-CUT BLADE FOR WOOD & METAL



WOOD&METAL

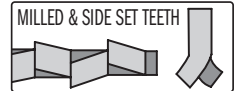

PACK Quantity	W mm	I mm	TPI		ORDER NO. Universal Arbor	ORDER NO. Arbor for FEIN® SuperCut
1 in Clamshell	22	48	18	10	OMM10-X1	OMS10-X1
5 in Clamshell	22	48	18	5	OMM10-X5	OMS10-X5
50 in Bulk Pack	22	48	18	2	OMM10-X50	OMS10-X50

OMM11

Universal Arbor

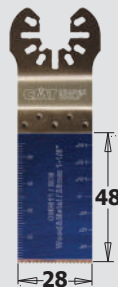

OMS11

Arbor for
FEIN® SuperCut
FESTOOL® VECTURO®

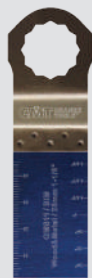

28mm PLUNGE & FLUSH-CUT BLADE FOR WOOD & METAL



WOOD&METAL

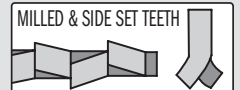

PACK Quantity	W mm	I mm	TPI		ORDER NO. Universal Arbor	ORDER NO. Arbor for FEIN® SuperCut
1 in Clamshell	28	48	18	10	OMM11-X1	OMS11-X1
5 in Clamshell	28	48	18	5	OMM11-X5	OMS11-X5
50 in Bulk Pack	28	48	18	2	OMM11-X50	OMS11-X50

OMM12

Universal Arbor

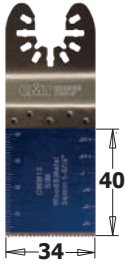

OMS12

Arbor for FEIN® SuperCut FESTOOL® VECTURO®



OMS12
W=32mm

34mm PLUNGE & FLUSH-CUT FOR WOOD & METAL

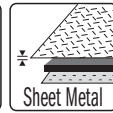

WOOD&METAL

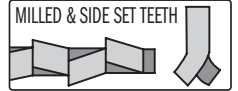

BIM
8% Co

PACK Quantity	W mm	I mm	TPI		ORDER NO. Universal Arbor	ORDER NO. Arbor for FEIN® Supercut
1 in Clamshell	34	40	18	10	OMM12-X1	OMS12-X1
5 in Clamshell	34	40	18	5	OMM12-X5	OMS12-X5
50 in Bulk Pack	34	40	18	2	OMM12-X50	OMS12-X50

OMM13

Universal Arbor

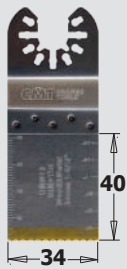

OMS13

Arbor for FEIN® SuperCut FESTOOL® VECTURO®



OMS13
W=32mm

34mm PLUNGE & FLUSH-CUT BLADE FOR WOOD & METAL

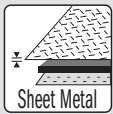

WOOD&METAL

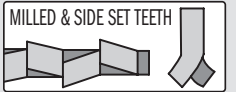

BIM
TiN

EXTRA LONG LIFE
130% LONGER LIFE

PACK Quantity	W mm	I mm	TPI		ORDER NO. Universal Arbor	ORDER NO. Arbor for FEIN® Supercut
1 in Clamshell	34	40	18	10	OMM13-X1	OMS13-X1
5 in Clamshell	34	40	18	5	OMM13-X5	OMS13-X5
50 in Bulk Pack	34	40	18	2	OMM13-X50	OMS13-X50

OMM14

Universal Arbor

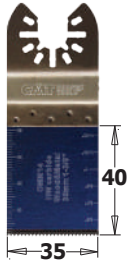

OMS14

Arbor for FEIN® SuperCut FESTOOL® VECTURO®



35mm PLUNGE & FLUSH-CUT BLADE FOR WOOD & METAL

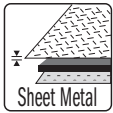

WOOD&METAL

HW

EXTRA LONG LIFE
2X LONGER LIFE

PACK Quantity	W mm	I mm	TPI		ORDER NO. Universal Arbor	ORDER NO. Arbor for FEIN® Supercut
1 in Clamshell	35	40	20	10	OMM14-X1	OMS14-X1

OMM35

Universal Arbor



OMS35

Arbor for FEIN® SuperCut FESTOOL® VECTURO®



EXTRA LONG

45mm PLUNGE & FLUSH-CUT BLADE FOR WOOD & METAL

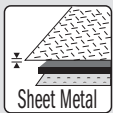

WOOD&METAL

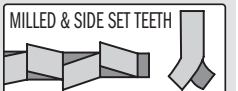

BIM
8% Co

PACK Quantity	W mm	I mm	TPI		ORDER NO. Universal Arbor	ORDER NO. Arbor for FEIN® Supercut
5 in Clamshell	42	68	18	5	OMM35-X5	OMS35-X5
50 in Bulk Pack	42	68	18	2	OMM35-X50	OMS35-X50

Accessories for Multi-Cutters

OMM15

Universal Arbor

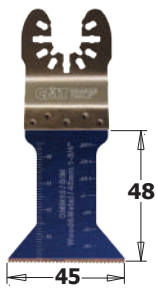

OMS15

Arbor for FEIN® SuperCut FESTOOL® VECTURO®



45mm PLUNGE & FLUSH-CUT BLADE FOR WOOD & METAL

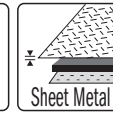
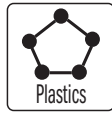

WOOD&METAL

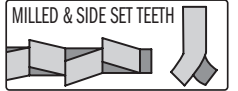

BIM
8% Co

PACK Quantity	W mm	I mm	TPI	Box	ORDER NO. Universal Arbor	ORDER NO. Arbor for FEIN® SuperCut
1 in Clamshell	45	48	18	10	OMM15-X1	OMS15-X1
5 in Clamshell	45	48	18	5	OMM15-X5	OMS15-X5
50 in Bulk Pack	45	48	18	2	OMM15-X50	OMS15-X50

OMM16

Universal Arbor

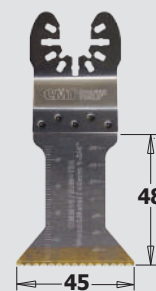

OMS16

Arbor for FEIN® SuperCut FESTOOL® VECTURO®



45mm PLUNGE & FLUSH-CUT BLADE FOR WOOD & METAL

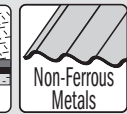
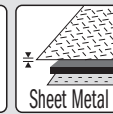

WOOD&METAL

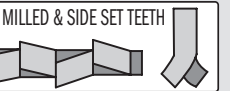

BIM
TiN

EXTRA LONG LIFE
130% LONGER LIFE

PACK Quantity	W mm	I mm	TPI	Box	ORDER NO. Universal Arbor	ORDER NO. Arbor for FEIN® SuperCut
1 in Clamshell	45	48	18	10	OMM16-X1	OMS16-X1
5 in Clamshell	45	48	18	5	OMM16-X5	OMS16-X5
50 in Bulk Pack	45	48	18	2	OMM16-X50	OMS16-X50

OMM17

Universal Arbor



OMS17

Arbor for FEIN® SuperCut FESTOOL® VECTURO®



87mm RADIAL SAW BLADE FOR WOOD & METAL, SEGMENTED

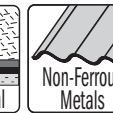
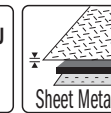
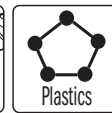

WOOD&METAL

BIM
8% Co

LONG LIFE

PACK Quantity	W mm	TPI	Box	ORDER NO. Universal Arbor	ORDER NO. Arbor for FEIN® SuperCut
1 in Clamshell	87	20	10	OMM17-X1	OMS17-X1

OMM18

Universal Arbor



OMS18

Arbor for FEIN® SuperCut FESTOOL® VECTURO®

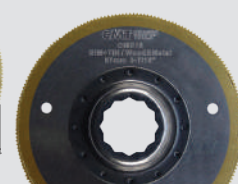

87mm RADIAL SAW BLADE FOR WOOD & METAL, SEGMENTED

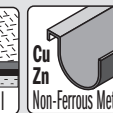
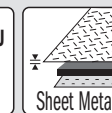
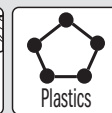

WOOD&METAL

BIM
TiN

EXTRA LONG LIFE
130% LONGER LIFE

PACK Quantity	W mm	TPI	Box	ORDER NO. Universal Arbor	ORDER NO. Arbor for FEIN® SuperCut
1 in Clamshell	87	20	10	OMM18-X1	OMS18-X1

OMM19

Universal Arbor

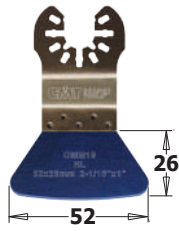

OMS19

Arbor for
FEIN® SuperCut
FESTOOL® VECTURO®



52mm RIGID SCRAPER BLADE FOR ALL MATERIALS

MULTI-MATERIALS

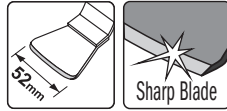

PACK Quantity	W mm	I mm		ORDER NO. Universal Arbor	ORDER NO. Arbor for FEIN® Supercut
1 in Clamshell	52	26	10	OMM19-X1	OMS19-X1
5 in Clamshell	52	26	5	OMM19-X5	OMS19-X5

OMM20

Universal Arbor

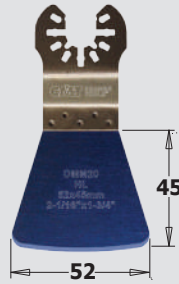

OMS20

Arbor for
FEIN® SuperCut
FESTOOL® VECTURO®



52mm FLEXIBLE SCRAPER FOR ALL MATERIALS

MULTI-MATERIALS

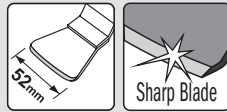

PACK Quantity	W mm	I mm		ORDER NO. Universal Arbor	ORDER NO. Arbor for FEIN® Supercut
1 in Clamshell	52	45	10	OMM20-X1	OMS20-X1
5 in Clamshell	52	45	5	OMM20-X5	OMS20-X5

OMM21

Universal Arbor

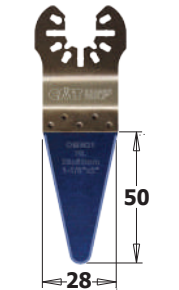

OMS21

Arbor for
FEIN® SuperCut
FESTOOL® VECTURO®



28mm SHARP CORNER SCRAPER FOR ALL MATERIALS

MULTI-MATERIALS

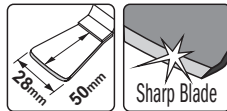

PACK Quantity	W mm	I mm		ORDER NO. Universal Arbor	ORDER NO. Arbor for FEIN® Supercut
1 in Clamshell	28	50	10	OMM21-X1	OMS21-X1
5 in Clamshell	28	50	5	OMM21-X5	OMS21-X5
50 in Bulk Pack	28	50	2	OMM21-X50	OMS21-X50

OMM22

Universal Arbor



OMS22

Arbor for
FEIN® SuperCut
FESTOOL® VECTURO®

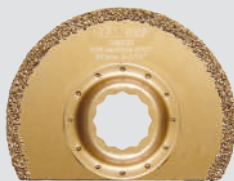

87mm CARBIDE GRIT RADIAL SAW BLADE, SEGMENTED

MASONRY

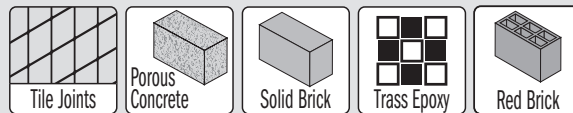

PACK Quantity	W mm	K mm		ORDER NO. Universal Arbor	ORDER NO. Arbor for FEIN® Supercut
1 in Clamshell	87	2,2	10	OMM22-X1	OMS22-X1

OMM23

Universal Arbor



OMS23

Arbor for
FEIN® SuperCut
FESTOOL® VECTURO®



87mm DIAMOND COATED RADIAL SAW BLADE, SEGMENTED

MASONRY

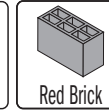
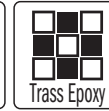
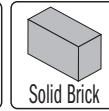
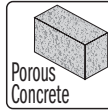

PACK Quantity	W mm	K mm		ORDER NO. Universal Arbor	ORDER NO. Arbor for FEIN® Supercut
1 in Clamshell	87	1,6	10	OMM23-X1	OMS23-X1
25 in Bulk Pack	87	1,6	2	OMM23-X25	OMS23-X25

OMM24

Universal Arbor



OMS24

Arbor for
FEIN® SuperCut
FESTOOL® VECTURO®



65mm CARBIDE GRIT RADIAL SAW BLADE, SEGMENTED

MASONRY

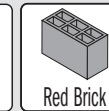
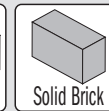
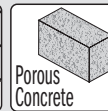
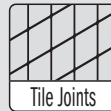

PACK Quantity	W mm	K mm		ORDER NO. Universal Arbor	ORDER NO. Arbor for FEIN® Supercut
1 in Clamshell	65	1,6	10	OMM24-X1	OMS24-X1

OMM27

Universal Arbor



OMS27

Arbor for
FEIN® SuperCut
FESTOOL® VECTURO®



65mm DIAMOND GRIT COATED RADIAL SAW BLADE, SEGMENTED

MASONRY

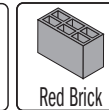
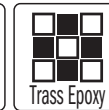
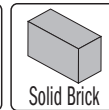
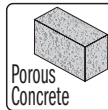

PACK Quantity	W mm	K mm		ORDER NO. Universal Arbor	ORDER NO. Arbor for FEIN® Supercut
1 in Clamshell	65	2	10	OMM27-X1	OMS27-X1

OMM26

Universal Arbor



35mm CARBIDE GRIT FINGERTIP RASP, DOUBLE-SIDED

MASONRY

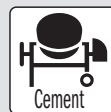
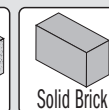
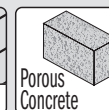
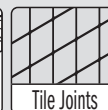

PACK Quantity	W mm	I mm		ORDER NO. Universal Arbor
1 in Clamshell	33	35	10	OMM26-X1

OMM25

Universal Arbor



80mm CARBIDE GRIT DELTA RASP

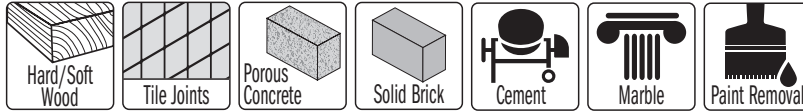

MASONRY



PACK Quantity	W mm			ORDER NO. Universal Arbor
1 in Clamshell	80		10	OMM25-X1

OMM28

Universal Arbor



57mm DIAMOND COATED SEGMENT SAW BLADE

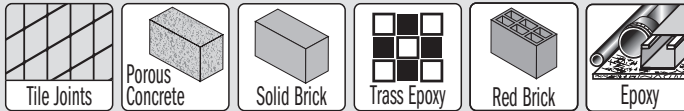

MASONRY



PACK Quantity	W mm	K mm		ORDER NO. Universal Arbor
1 in Clamshell	57	2	10	OMM28-X1
25 in Bulk Pack	57	2	4	OMM28-X25

OMM29

Universal Arbor



OMS29

Arbor for FEIN® SuperCut FESTOOL® VECTURO®



65mm CARBIDE GRIT GROUT AND MORTAR REMOVER

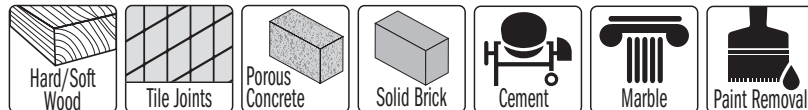

MASONRY



PACK Quantity	W mm			ORDER NO. Universal Arbor	ORDER NO. Arbor for FEIN® Supercut
1 in Clamshell	65		10	OMM29-X1	OMS29-X1

OMM30

Universal Arbor



OMS30

Arbor for FEIN® SuperCut FESTOOL® VECTURO®



93mm DELTA SANDING PAD, PERFORATED



MULTI-MATERIALS

PACK Quantity	W mm			ORDER NO. Universal Arbor	ORDER NO. Arbor for FEIN® Supercut
1 in Clamshell	93		10	OMM30-X1	OMS30-X1

93mm Delta Polishing Fleece. Perforated



OMA30000

SEE PAGE 120



OMA30

93mm Aluminium-Oxide Delta Sandpaper for Wood. Perforated

OMM-X4

Universal Arbor

4 PIECE GENERAL PURPOSE SET FOR MULTI-CUTTERS

- 2 blades with Japanese Tothing for cutting wood, chipboard, plasterboard and plastics.
- 2 blades in BIM for cutting wood products, chipboard, plasterboard, fiberglass, epoxy resins, soft plastics, sheet metal, aluminium pipes and profiles. Cuts through embedded nails in wood up to 5mm in diameter as well as porous concrete.



WOOD

WOOD&NAILS

8 Sets in End-cap display (minimum 8 pieces or multiple)



PACK Quantity	MATERIAL	W mm	I mm	TPI	ORDER NO.
1	HCS	34	40	14	OMM04-X1
1	HCS	68	40	14	OMM06-X1
1	BIM	34	40	18	OMM12-X1
1	BIM	45	48	18	OMM15-X1

OMM-X33

Universal Arbor

33 PIECE GENERAL PURPOSE SET FOR MULTI-CUTTERS

- blades for cutting wood, plastic, plasterboard, sheet metal, profiles and pipes in aluminum and copper.
- scraper to remove carpet adhesive/glue residues as well as paint and silicone residues.
- sanding pad and sanding sheets (60, 100, 180 grit).



6 Sets Bulk Pack

PACK Quantity	W mm	I mm	TPI	GRIT	ORDER NO.
1	34	40	18		OMM12-X1
1	52	45			OMM20-X1
1	93				OMM30-X1
10	93			60	OMA30060-X10
10	93			100	OMA30100-X10
10	93			180	OMA30180-X10

OMM-X37

Universal Arbor

37 PIECE GENERAL PURPOSE SET FOR MULTI-CUTTERS

- blades (in two diameters) for cutting in wood, plastic, plasterboard, sheet metal, profiles and pipes in aluminum and copper.
- segmented blade for cutting wood and metal.
- scraper for removing carpet adhesive/glue residues as well as paint and silicone residues.
- rasp in carbide for grinding/sanding/removal of tiles, plasterboard, cement, wood and construction materials.
- specially designed blade to remove mortar, bonding materials, cement and stone, even in hard to reach corners.
- sanding pad and sanding sheets (60, 100, 180 grit).



FRONT



BACK

PACK Quantity	W mm	I mm	TPI	GRIT	ORDER NO.
1	10	28	18		OMM09-X1
1	34	40	18		OMM12-X1
1	87		20		OMM17-X1
1	52	45			OMM20-X1
1	80				OMM25-X1
1	65				OMM29-X1
1	93			10	OMM30-X1
10	93			60	OMA30060-X10
10	93			100	OMA30100-X10
10	93			180	OMA30180-X10



4 Sets in End-cap display (minimum 4 pieces or multiple)

TOOLS WITH BORE & KNIVES

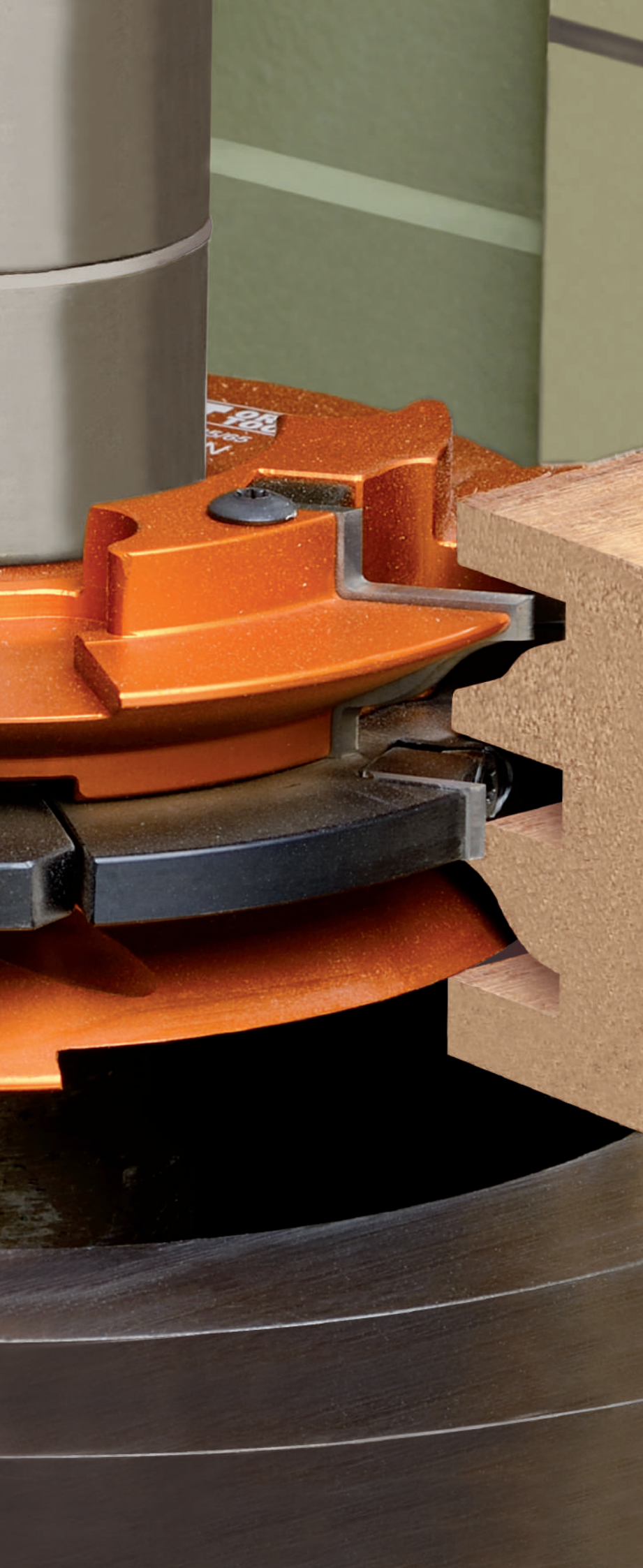

PRODUCTS	PAGE
Rabbeting Cutter Heads	132-133
Adjustable Grooving Set	134-135
Planing & Jointing Spiral Cutter Heads	136
Adjustable Rounding & Chamfering Set	137
Chamfer Cutter Heads	138-139
Multiradius Roundover Cutter Heads	140-142
Jointing Cutter Heads	143-145
Panel Cutter Heads	146-150
Cutter Heads with Universal Knives & Sets	151-153
Profile Knives & Limiters	154-156
Blank Knives & Limiters (to be sharpened)	167
Bore Reducers	167
HWM Reversible Knives for Portable Planers	168
HS Corrugated Back Moulder Knives	169
Magnetic Knife Setting Jigs	169
Planer & Jointer Knives	170-171
HWM Reversible Knives	172-173



Cutter Heads for Rabbeting & Profile Knives 40mm



694.020

- These cutter heads have been designed for:
- Rabbeting from either top or bottom.
 - Jointing.
 - Grooving.
 - Profile knives on pages 154~163

For use on spindle moulder machines, moulder, double-end tenoners and edging machines. Suitable for all materials, but best on chipboard, MDF, wood composites, plastic materials and laminates.

TECHNICAL DETAILS:

- Hard aluminium alloy body with high resistance to tensile and yield stress.
- 2 universal HWM straight knives 40x12x1,5mm [Z2].
- 2 universal HWM scoring knives 14x14x2mm [V2].
- Tools for manual feed (MAN).
- Pins for the automatic positioning of the knives.

SAFETY TIPS



The **TW-006** Torque Screwdriver is recommended for the proper fastening of screws (see page 413).

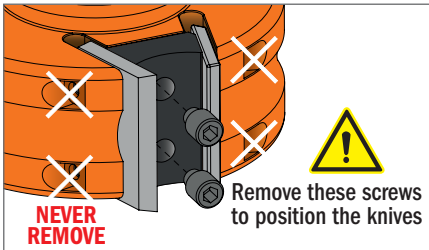

Supplied in a sturdy plastic carry case

Drawing is 1:1 scale

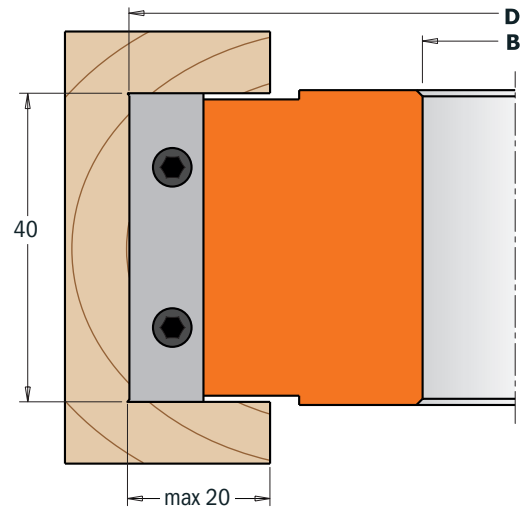
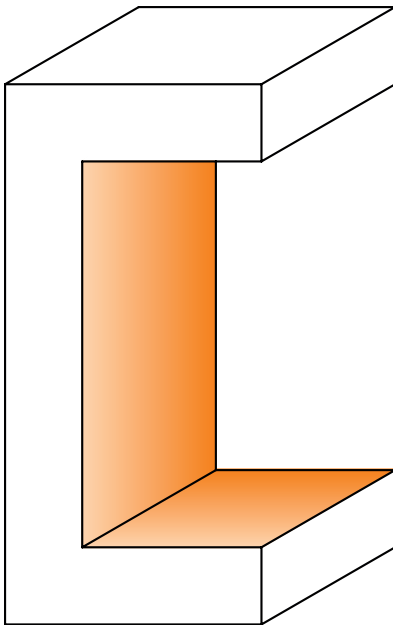

To use with all 40mm profile knives (refer to pages 154 to 163)

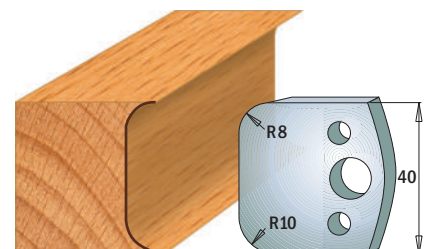
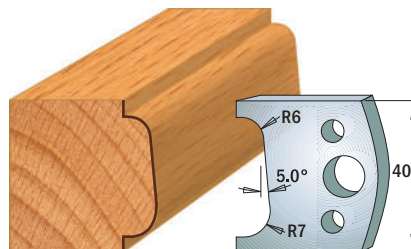
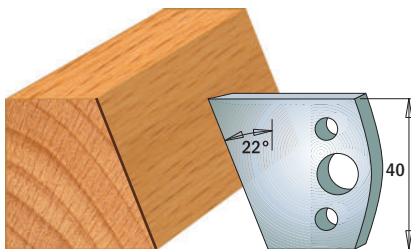

D mm	B mm	I mm	Z+V	RPM		ORDER NO.
100	30	40	2+2	5800~9000	1	694.020.30
100	31,75	40	2+2	5800~9000	1	694.020.31
125	35	40	2+2	4800~7400	1	694.020.35
125	40	40	2+2	4800~7400	1	694.020.40
125	50	40	2+2	4800~7400	1	694.020.50

Spare parts

790.140.00*	990.093.00	991.073.00	790.400.00*	693.999.01	990.065.00	991.064.00
790.140.00*	990.093.00	991.073.00	790.400.00*	693.999.01	990.065.00	991.064.00
790.140.00*	990.093.00	991.073.00	790.400.00*	693.999.01	990.065.00	991.064.00
790.140.00*	990.093.00	991.073.00	790.400.00*	693.999.01	990.065.00	991.064.00
790.140.00*	990.093.00	991.073.00	790.400.00*	693.999.01	990.065.00	991.064.00

Spare parts: **691.192** Pair of limiters 38mm
695.020.01 Indexable knife edge block 38x4x15mm

*Minimum 10 pieces or multiple

Rabbeting Cutter Heads with Shear Angle



694.100

These cutter heads have been designed for:

- Rabbeting from either top or bottom.
- Jointing.
- Grooving.

For use on spindle moulder machines, double-end tenoner and edging machines.

Suitable for all materials, but best on chipboard, MDF, wood composites, plastic materials and laminates. Improved design with shear angle.

TECHNICAL DETAILS:

- Hard aluminium alloy body with high resistance to tensile and yield stress.
- 2 universal HWM straight knives 50x12x1,5mm [Z2], 1 up cut - 1 down cut.
- 4 universal HWM scoring knives 14x14x2mm [V4].
- Tools for manual feed (MAN).
- Pins for automatic positioning of the knives.

SAFETY TIPS



The **TW-006** Torque Screwdriver is recommended for the proper fastening of screws (see page 413).

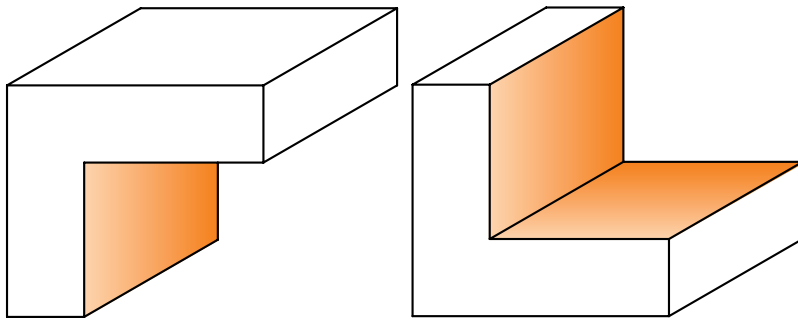

Supplied in a sturdy plastic carry case

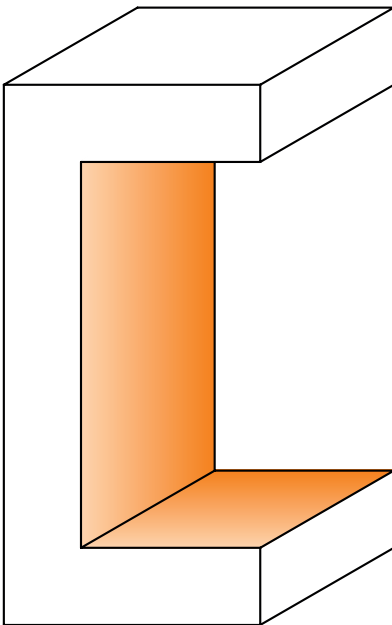

Drawing is 1:1 scale

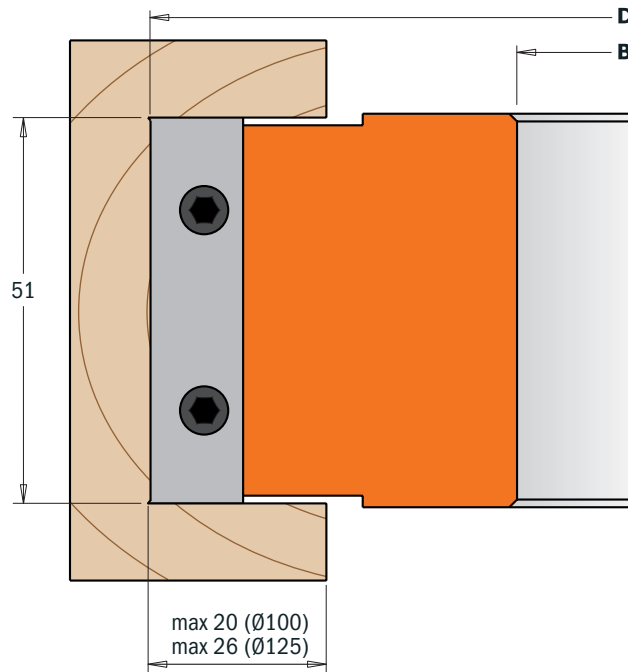

D mm	B mm	I mm	Z+V	RPM		ORDER NO.							
100	19,05	51	2+4	7500~12500	1	694.100.19	790.140.00*	990.093.00	991.073.00	790.500.00*	695.999.46	990.064.00	991.064.00
100	30	51	2+4	7500~12500	1	694.100.30	790.140.00*	990.093.00	991.073.00	790.500.00*	695.999.46	990.064.00	991.064.00
100	31,75	51	2+4	7500~12500	1	694.100.31	790.140.00*	990.093.00	991.073.00	790.500.00*	695.999.46	990.064.00	991.064.00
100	35	51	2+4	7500~12500	1	694.100.35	790.140.00*	990.093.00	991.073.00	790.500.00*	695.999.46	990.064.00	991.064.00
125	40	51	2+4	6100~10000	1	694.125.40	790.140.00*	990.093.00	991.073.00	790.500.00*	695.999.46	990.064.00	991.064.00
125	50	51	2+4	6100~10000	1	694.125.50	790.140.00*	990.093.00	991.073.00	790.500.00*	695.999.46	990.064.00	991.064.00

Spare parts

*Minimum 10 pieces or multiple

Adjustable Grooving Cutter Heads Sets (3 pcs.)



694.001

These cutter heads are the ideal tools to create precision slots and grooves 4-15mm in depth.

These sets include:

- 2 cutter heads type **(A)** [Z4 + V4].
- 1 cutter head type **(B)** [Z2].
- 12 spacer rings from 0,1 to 2mm.

For use on spindle moulder machines, moulder, double-end tenoner and edging machines. Perfect grooving on all materials, but ideal on hardwood, plywood and laminated panels.

SAFETY TIPS



The **TW-006** Torque Screwdriver is recommended for the proper fastening of screws (see page 413).

TECHNICAL DETAILS:

- Strength steel body.
- 2 HWM Knives 7,65x12x1,5mm [Z2].
- 4 HWM Knives 18x18x1,95mm [Z4].
- 4 HWM Knives 14x14x1,2mm [V4].
- Tools for manual feed (MAN).
- Pins for automatic positioning of the knives.



Supplied in a sturdy plastic carry case

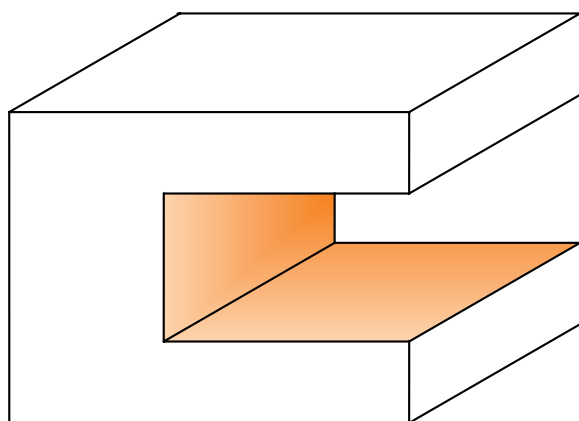
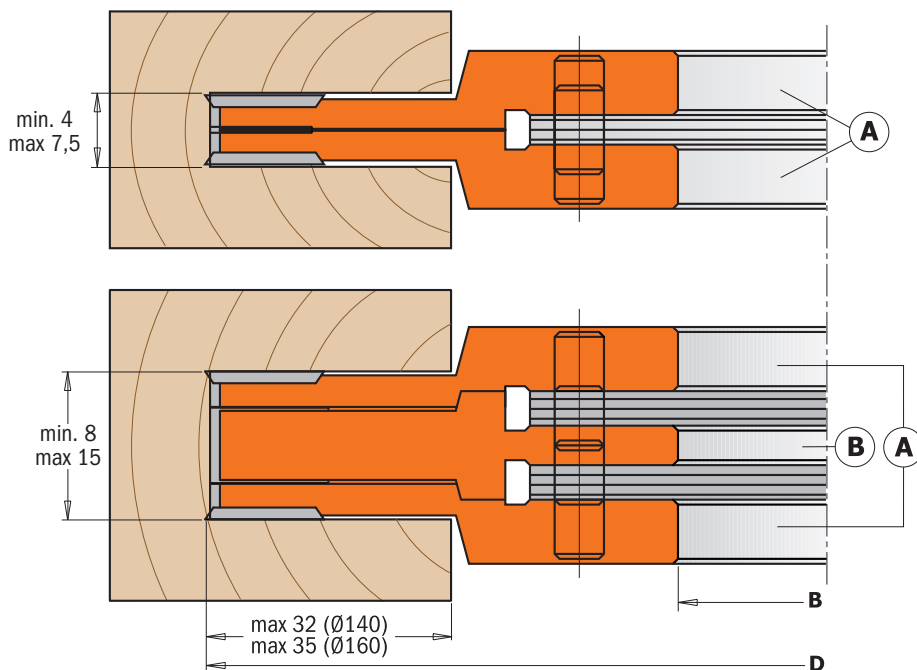

Drawing is 1:1 scale

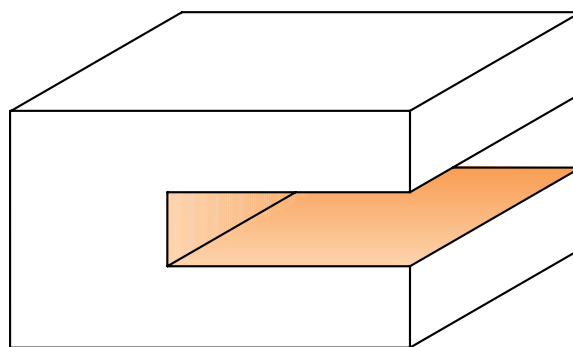

D mm	B mm	Z+V	RPM		ORDER NO.
140	30	4+4	5500~9500	1	694.001.30
140	31,75	4+4	5500~9500	1	694.001.31
140	35	4+4	5500~9500	1	694.001.35
160	40	4+4	4800~8300	1	694.001.40
160	50	4+4	4800~8300	1	694.001.50

Spare parts

790.181.00*	790.140.10*	790.076.00*	695.998.21
790.181.00*	790.140.10*	790.076.00*	695.998.22
790.181.00*	790.140.10*	790.076.00*	695.998.23
790.181.00*	790.140.10*	790.076.00*	695.998.24
790.181.00*	790.140.10*	790.076.00*	695.998.25

Spare parts: For cutter heads (A)

- 990.079.00** M4x3,2mm TORX® screws
- 991.069.00** T9 TORX® key
- 695.996.02** M4 (Ø12x1,7mm) threaded ring
- 695.996.01** M4 (Ø10x1,6mm) threaded ring

For cutter heads (B)

- 695.999.07** 7x11x9,5mm wedge for knives
- 990.063.00** M5x18mm screw
- 991.072.00** T20 TORX® key

*Minimum 10 pieces or multiple

Adjustable Grooving Cutter Heads Sets (2 pcs.)



694.021 - 694.022



These cutter heads are the perfect tools to create precision slots and grooves 14 - 39mm in depth. This set includes:

- 1 cutter head type **(A)** [Z2 + V2]
- 1 cutter head type **(B)** [Z2 + V2]
- set of spacer rings.

For use on spindle moulder machines, moulders, double-end tenoners and edging machines. Perfect grooving on all materials, but ideal on hard wood, plywood and laminated panels.



Supplied in a sturdy plastic carry case

TECHNICAL DETAILS:

- Strength hard aluminium alloy body.
- **694.021:** 8 HWM knives 13,6x13,6x2mm.
- **694.022:** 4 HWM knives 19,5x12x1,5mm.
4 HWM knives 14x14x2mm.
- Tools for manual feed (MAN).
- Pins for the automatic positioning of the knives.

SAFETY TIPS



The **TW-006** Torque Screwdriver is recommended for the proper fastening of screws (see page 413).

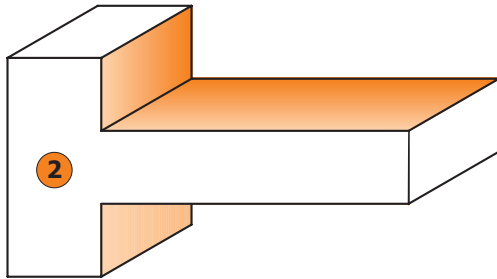
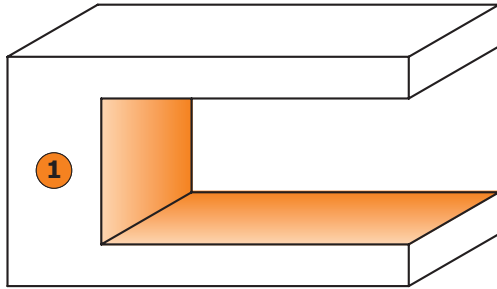

Drawing is 1:1 scale

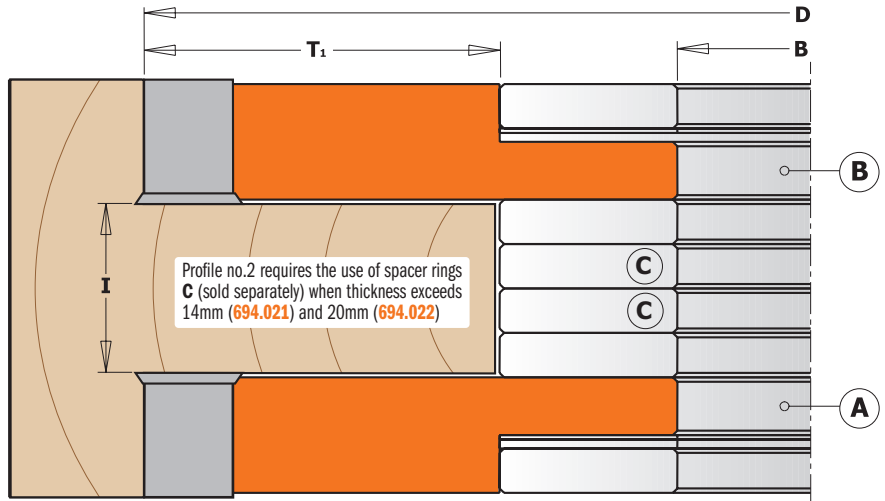
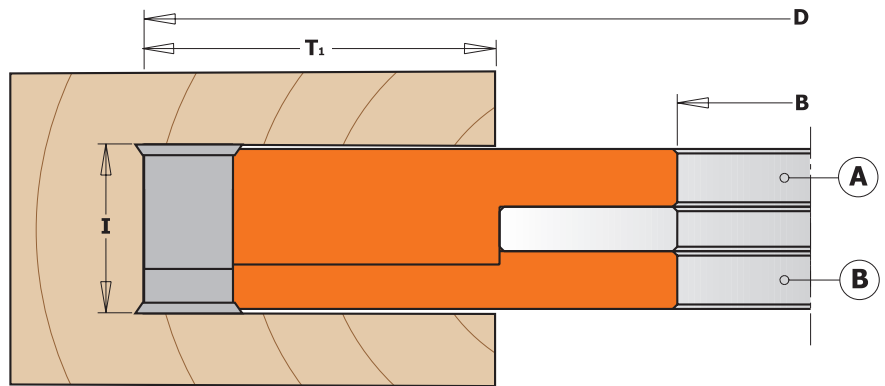

299 Spacer Rings (Optional)

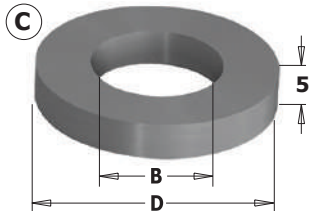

B mm	D mm	ORDER NO.
30	60	299.560.30
31,75	60	299.560.31
35	60	299.560.35
40	60	299.560.40
50	70	299.570.50

D mm	I mm	B mm	T ₁ mm	Z+V	RPM		ORDER NO.
150	14-27	30	44	4+4	5000~8000	1	694.021.30
150	14-27	31,75	44	4+4	5000~8000	1	694.021.31
150	14-28	30	44	4+4	5000~8000	1	694.021.35
150	14-27	40	44	4+4	5000~8000	1	694.021.40
160	14-27	50	44	4+4	5000~8000	1	694.021.50
170	20-39	30	54	4+4	4400~7400	1	694.022.30
170	20-39	31,75	54	4+4	4400~7400	1	694.022.31
170	20-39	35	54	4+4	4400~7400	1	694.022.35
170	20-39	40	54	4+4	4400~7400	1	694.022.40
170	20-39	50	49	4+4	4400~7400	1	694.022.50

Spare parts

790.136.00*	990.093.00			695.998.41
790.136.00*	990.093.00			695.998.42
790.136.00*	990.093.00			695.998.43
790.136.00*	990.093.00			695.998.44
790.136.00*	990.093.00			695.998.45
790.140.00*	990.093.00	790.195.12*	990.094.00	695.998.46
790.140.00*	990.093.00	790.195.12*	990.094.00	695.998.47
790.140.00*	990.093.00	790.195.12*	990.094.00	695.998.48
790.140.00*	990.093.00	790.195.12*	990.094.00	695.998.49
790.140.00*	990.093.00	790.195.12*	990.094.00	695.998.50

Spare parts: **991.072.00** T20 TORX® key
991.073.00 T25 TORX® key

*Minimum 10 pieces or multiple



694.019

These new cutter heads have been designed for planing and jointing soft or solid wood panels on spindle moulder machines. Ideal for routing curved elements with the aid of a bearing guide (sold separately) and a guide fence.

TECHNICAL DETAILS:

- Hard aluminium alloy body with high resistance to tensile and yield stress.
- 12 HWM Knives 14x14x2mm [Z2] with 4 spiral indexing.
- Tools for manual feed (MAN).

Supplied in a sturdy plastic twistpack.

SAFETY TIPS



The **TW-006** Torque Screwdriver is recommended for the proper fastening of screws (see page 413).

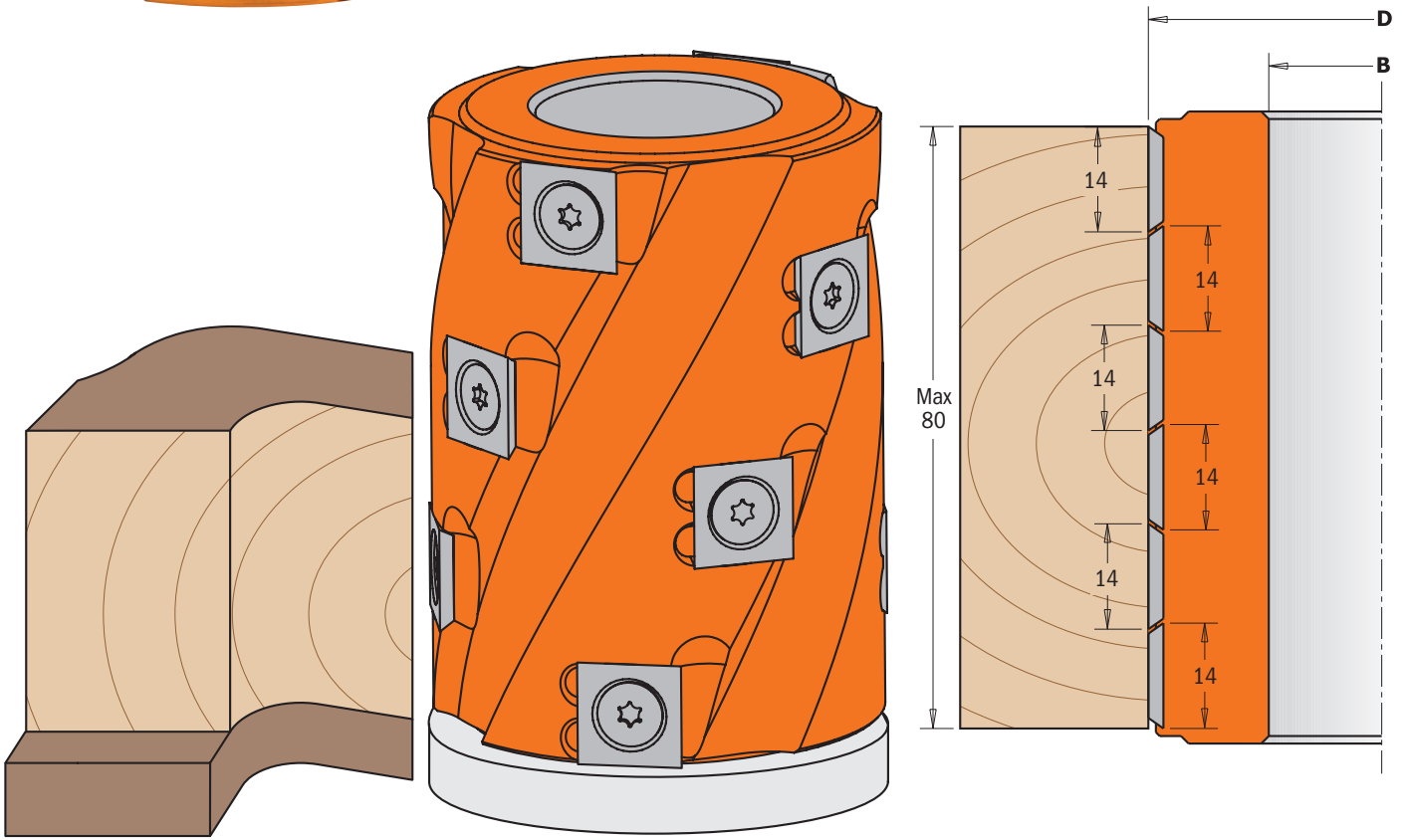

Optional bearing

D mm	I mm	B mm	Z	RPM		ORDER NO.
62	80	30	12	8000~12000	1	694.019.30
62	80	35	12	8000~12000	1	694.019.35
80	80	40	12	8000~12000	1	694.019.40
80	80	50	12	8000~12000	1	694.019.50

Spare parts

790.140.00*	990.093.00	991.073.00
790.140.00*	990.093.00	991.073.00
790.140.00*	990.093.00	991.073.00
790.140.00*	990.093.00	991.073.00

*Minimum 10 pieces or multiple

- Optional: **791.051.00** 30x62x16mm bearing
791.052.00 35x62x14mm bearing
791.054.00 40x80x18mm bearing
791.053.00 50x80x16mm bearing

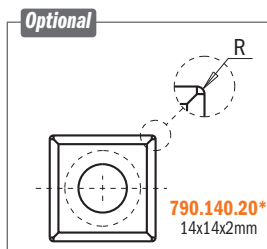

NOTE: Ideal for working curved elements together with the appropriate bearing (sold separately) and a guide fence. In order to achieve an extra-fine finish, order the optional knife **790.140.20***

Adjustable Rounding & Chamfering Cutter Heads Sets (2 pcs.)



Supplied in a sturdy plastic carry case

694.005



The CMT adjustable rounding and chamfering set consists of two pieces for easy to set up on your spindle moulder machine. Includes five different knives for rounding over top and bottom edges in one single pass with a radius of 2,3,4,5 or 6mm and for 45° chamfering on material 18mm to 50mm in thickness. The improved design with shear angle guarantees perfect finishing!
For use on spindle moulder machines.

TECHNICAL DETAILS:

- Hard aluminium alloy body with high resistance to tensile and yield stress.
- One pair of HWM top knives (A) radius 4mm and 45° chamfer (20x20,5x2mm) [Z2].
- One pair of HWM bottom knives (B) radius 4mm and 45° chamfer (20x20,5x2mm) [Z2].
- 2 HWM knives 50x12x1,5mm.
- Set of 21 spacer rings from 0,1 to 3mm.
- Tools for manual feed (MAN).
- Pins for the automatic positioning of the knives.

SAFETY TIPS

The **TW-006** Torque Screwdriver is recommended for the proper fastening of screws (see page 413).

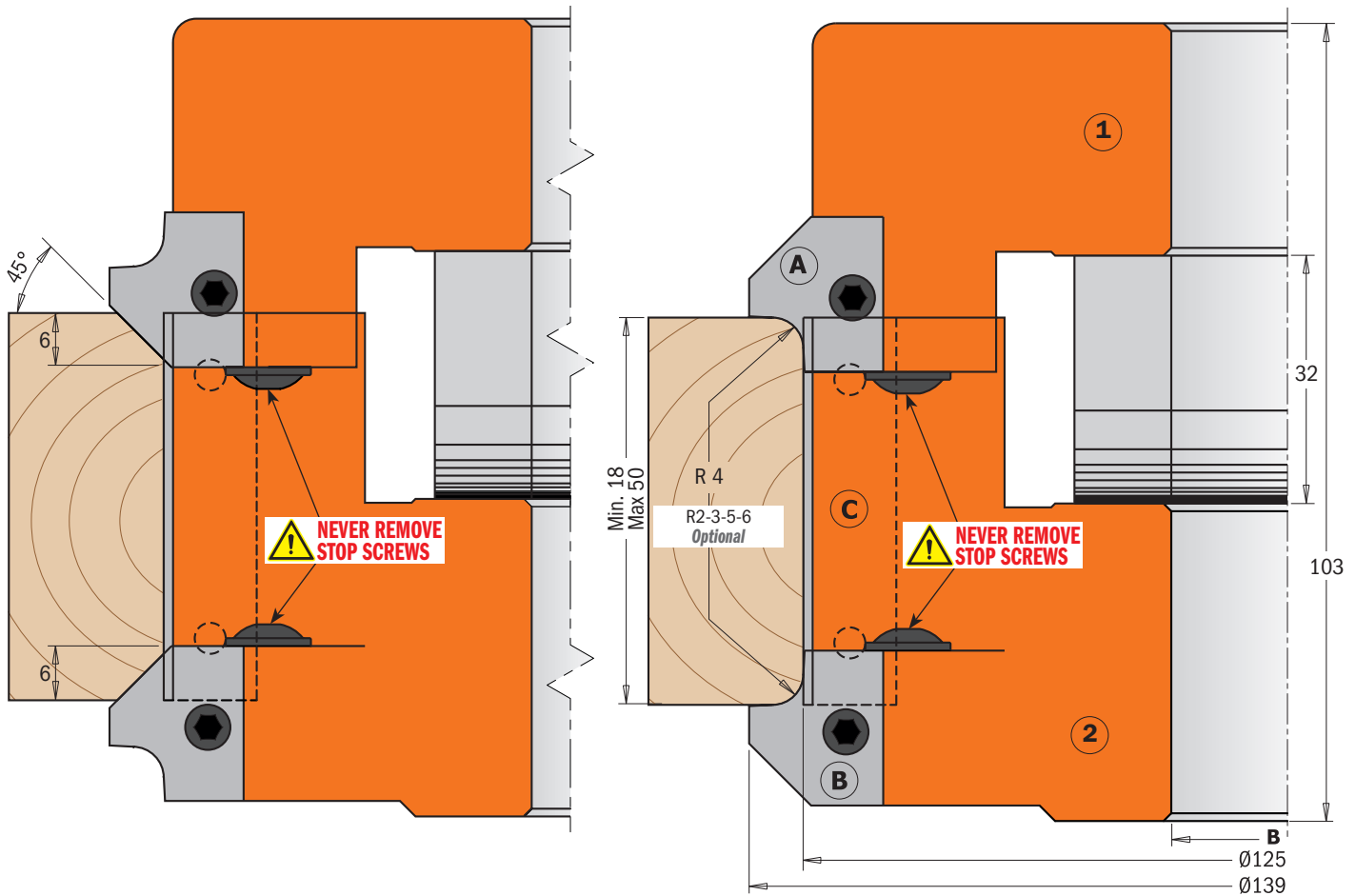

D mm	B mm	Z	RPM		ORDER NO.
139	30	2+2	5500~9400	1	694.005.30
139	31,75	2+2	5500~9400	1	694.005.31
139	35	2+2	5500~9400	1	694.005.35
139	40	2+2	5500~9400	1	694.005.40
139	50	2+2	5500~9400	1	694.005.50

Spare parts

17x11x9,5mm	46x11x9,5mm		
695.999.17	695.999.46	990.064.00	695.998.11
695.999.17	695.999.46	990.064.00	695.998.12
695.999.17	695.999.46	990.064.00	695.998.13
695.999.17	695.999.46	990.064.00	695.998.14
695.999.17	695.999.46	990.064.00	695.998.15

Spare parts: 695.005.A4 R=4+45° pair of knives for roundover/chamfer (top)
695.005.B4 R=4+45° pair of knives for roundover/chamfer (bottom)
790.500.00 50x12x1,5mm knives
991.064.00 4mm hex key
991.067.00 3mm hex key

Optional: 695.005.A2 R=2+45° pair of knives for roundover/chamfer (top)
695.005.A3 R=3+45° pair of knives for roundover/chamfer (top)
695.005.A5 R=5+45° pair of knives for roundover/chamfer (top)
695.005.A6 R=6+45° pair of knives for roundover/chamfer (top)
695.005.B2 R=2+45° pair of knives for roundover/chamfer (bottom)
695.005.B3 R=3+45° pair of knives for roundover/chamfer (bottom)
695.005.B5 R=5+45° pair of knives for roundover/chamfer (bottom)
695.005.B6 R=6+45° pair of knives for roundover/chamfer (bottom)

45° Chamfer Cutter Heads



694.002

CMT chamfer cutter heads carry out clean accurate bevels and joints for excellent edge work. For use on spindle moulder machines, moulder, double-end tenoners, edge banding machines. Suitable for all materials, but ideal on hardwood, plywood and laminated panels.

TECHNICAL DETAILS:

- Hard aluminium alloy body with high resistance to tensile and yield stress.
- 2 HMM Knives 50x12x1,5mm [Z2].
- Tools for manual feed (MAN).
- Pins for the automatic positioning of the knives



Supplied in a sturdy plastic carry case

SAFETY TIPS



The **TW-006** Torque Screwdriver is recommended for the proper fastening of screws (see page 413).

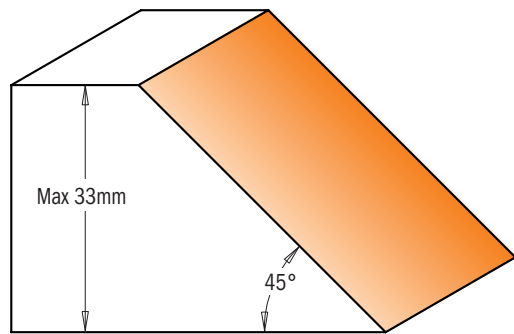
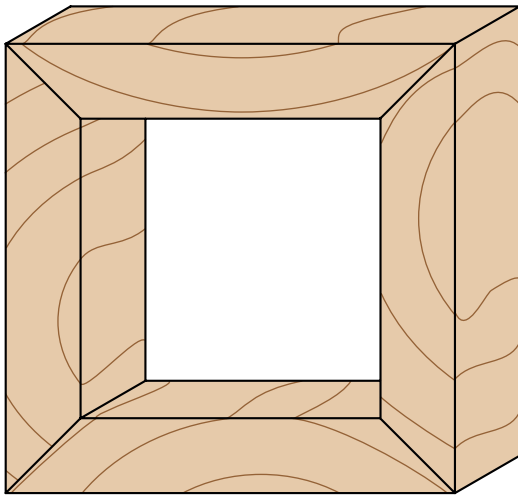
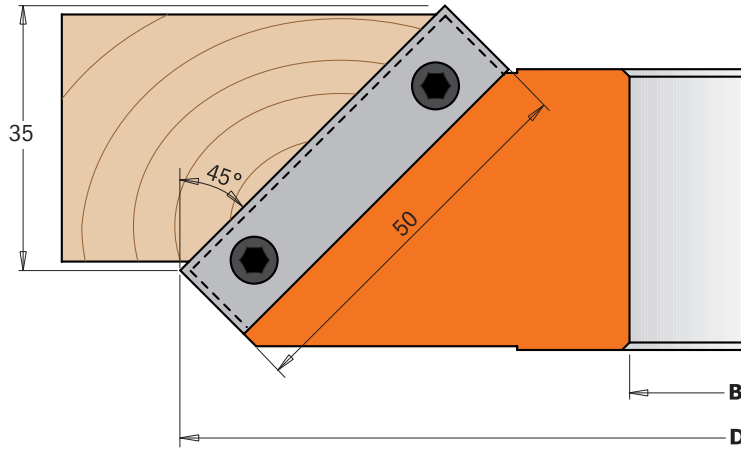

Drawing is 1:1 scale

D mm	B mm	Z	RPM		ORDER NO.
150	30	2	5100~8800	1	694.002.30
150	31,75	2	5100~8800	1	694.002.31
150	35	2	5100~8800	1	694.002.35
150	40	2	5100~8800	1	694.002.40
160	50	2	5100~8800	1	694.002.50

Spare parts

790.500.00*	695.999.42	990.064.00	991.064.00
790.500.00*	695.999.42	990.064.00	991.064.00
790.500.00*	695.999.42	990.064.00	991.064.00
790.500.00*	695.999.42	990.064.00	991.064.00
790.500.00*	695.999.42	990.064.00	991.064.00

*Minimum 10 pieces or multiple

Adjustable Chamfer Cutter Heads $\pm 45^\circ$



694.018

This adjustable chamfer cutter head carries out very precise cuts on solid boards. For use on spindle moulding machines, moulder, double-end tenoners and edging machines.



TECHNICAL DETAILS:

- Tool body made from high strength aluminum alloy extremely resistant to tensile and yield stress.
- Manual feed tool (MAN).
- 2 HWM knives 40x12x1,5mm [Z2].
- Adjustable swivelling blades.
- Range: $\pm 45^\circ$ (Rotates at $7,5^\circ$ intervals; Precision= $7,5^\circ$).

SAFETY TIPS

The **TW-006** Torque Screwdriver is recommended for the proper fastening of screws (see page 413).



Supplied in a sturdy plastic carry case

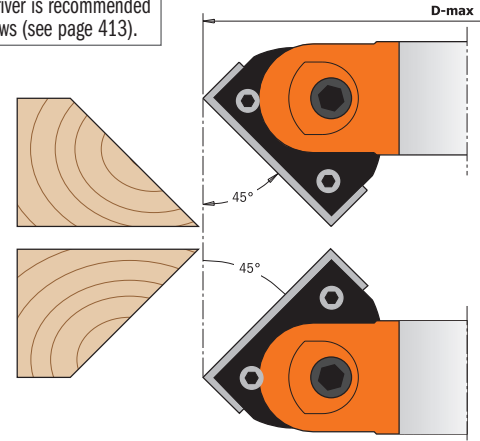
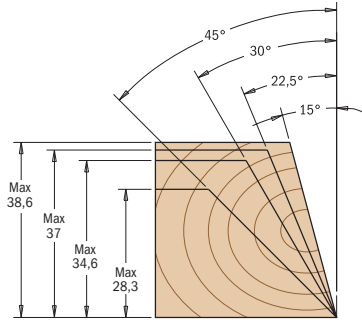
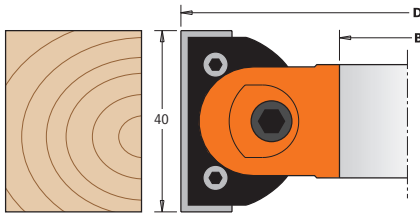

D mm	I mm	B mm	Z	D_Max 45° mm	RPM		ORDER NO.
120	40	30	2	140	6400~8500	1	694.018.30
120	40	35	2	140	6400~8500	1	694.018.35
145	40	40	2	165	5900~7400	1	694.018.40
145	40	50	2	165	5900~7400	1	694.018.50

Spare parts

695.018.01	790.400.00*	990.094.00	991.072.00
695.018.01	790.400.00*	990.094.00	991.072.00
695.018.01	790.400.00*	990.094.00	991.072.00
695.018.01	790.400.00*	990.094.00	991.072.00

Spare parts: 991.065.00 5mm hex key

*Minimum 10 pieces or multiple

Professional Adjustable Chamfer Cutter Heads $\pm 90^\circ$

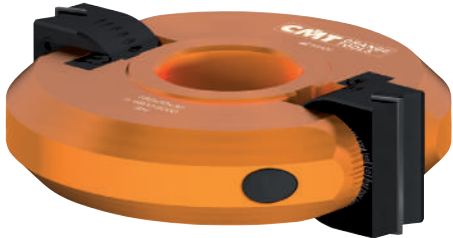

694.017

These new professional adjustable chamfer cutter heads carry out precise cuts, accurate bevels and joint work on solid wooden boards. For use on spindle moulder machines, moulder, double-end tenoner and edging machines.



TECHNICAL DETAILS:

- Tool body made from high strength aluminum alloy extremely resistant to tensile and yield stress.
- Manual feed tool (MAN).
- 2 HWM knives 50x12x1,5mm [Z2].
- Adjustable swivelling blades.
- Range $\pm 90^\circ$ (Rotates at $7,5^\circ$ intervals; Precision= $7,5^\circ$).



Supplied in a sturdy plastic carry case

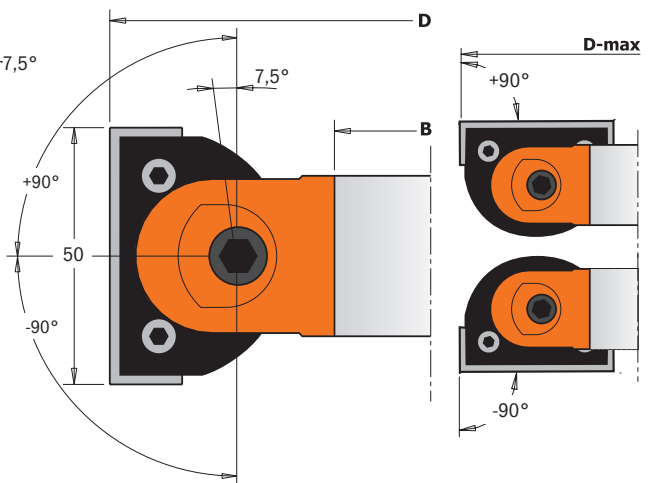
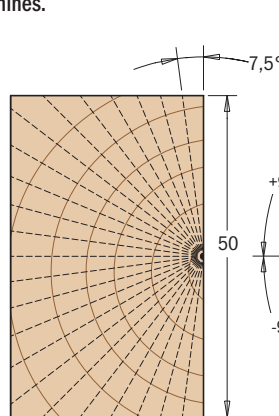

SAFETY TIPS

The **TW-006** Torque Screwdriver is recommended for the proper fastening of screws (see page 413).

D mm	I mm	B mm	Z	D_Max 45° mm	RPM		ORDER NO.
160	50	30	2	183	4800~6000	1	694.017.30
160	50	35	2	183	4800~6000	1	694.017.35
160	50	50	2	183	4800~6000	1	694.017.50

Spare parts

695.017.01	790.500.00*	695.999.48	990.106.00	991.067.00
695.017.01	790.500.00*	695.999.48	990.106.00	991.067.00
695.017.01	790.500.00*	695.999.48	990.106.00	991.067.00

Spare parts: 991.081.00 4mm hex key

*Minimum 10 pieces or multiple

Multiradius Roundover Cutter Heads



694.003

Innovative cutter heads featuring three different knives for making six radius roundover profiles. Standard cutter heads are sold with knives featuring 5 and 10mm radii; two more knife sets are available for making 4-8mm and 3-6mm radii. For use on spindle moulder machines, moulder machines and shaping machines. Suitable for all materials, but ideal on hard wood and panels.

TECHNICAL DETAILS:

- Hard aluminium alloy body with high resistance to tensile and yield stress.
- 2 HWM knives radius 5/10mm (25x24,8x2mm) [Z2].
- Tools for manual feed (MAN).
- Pins for the automatic positioning of the knives.

SAFETY TIPS



The **TW-006** Torque Screwdriver is recommended for the proper fastening of screws (see page 413).

Standard

Pair of knives **695.003.05**

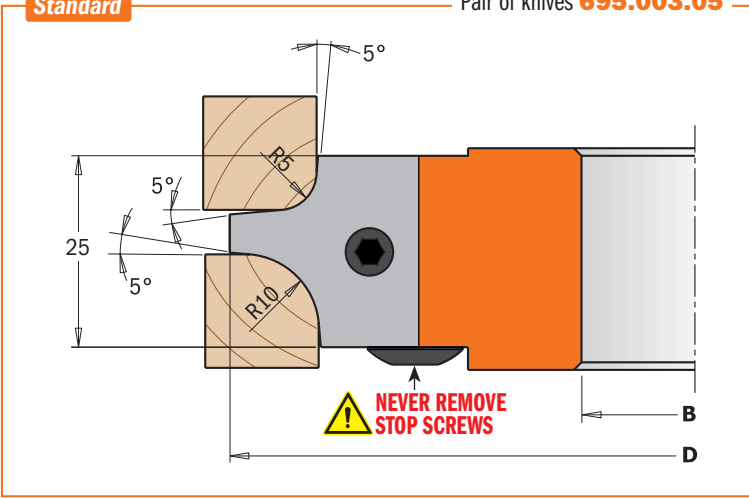

Supplied in a sturdy plastic carry case

Optional

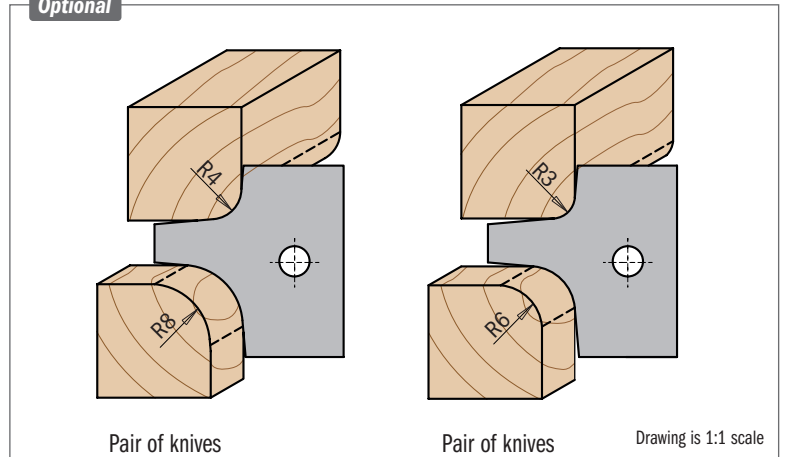

Pair of knives
695.003.04

Pair of knives
695.003.03

Drawing is 1:1 scale

D mm	B mm	Z	RPM		ORDER NO.
113	30	2	6700~11000	1	694.003.30
113	31,75	2	6700~11000	1	694.003.31
113	35	2	6700~11000	1	694.003.35
128	40	2	5900~9700	1	694.003.40
128	50	2	5900~9700	1	694.003.50

Spare parts

x2			
695.003.05	695.999.22	990.064.00	991.064.00
695.003.05	695.999.22	990.064.00	991.064.00
695.003.05	695.999.22	990.064.00	991.064.00
695.003.05	695.999.22	990.064.00	991.064.00
695.003.05	695.999.22	990.064.00	991.064.00

Optional: **695.003.04** R=4/8mm (25x24,8x2mm) pair of profiled knives

695.003.03 R=3/6mm (25x24,8x2mm) pair of profiled knives

Multiradius Roundover Cutter Heads



694.004



Innovative cutter heads supporting two different knives for making four radius roundover profiles. Standard cutter heads are sold with knives featuring 15 and 20mm radii; an additional knife set is available for 12-18mm radii. **For use on spindle moulder machines, moulder and shaping machines.** Suitable for all materials, but ideal on hard wood and wood panels.

TECHNICAL DETAILS:

- Hard aluminium alloy body with high resistance to tensile and yield stress.
- 2 HWM knives radius 15/20mm (45x34,5x2mm) [Z2].
- Tools for manual feed (MAN).
- Pins for the automatic positioning of the knives.

SAFETY TIPS



The **TW-006** Torque Screwdriver is recommended for the proper fastening of screws (see page 413).

Standard

Pair of knives **695.004.15**

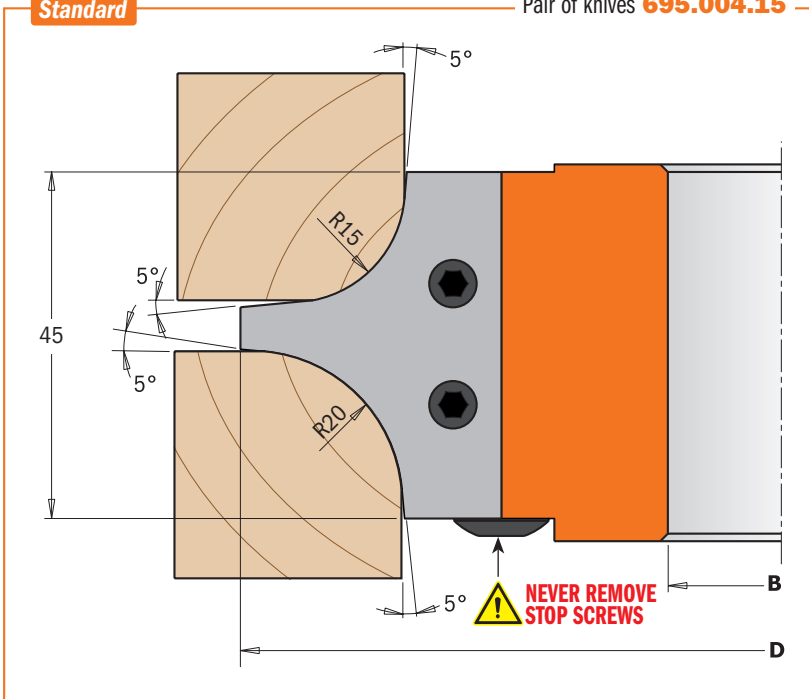

Supplied in a sturdy plastic carry case



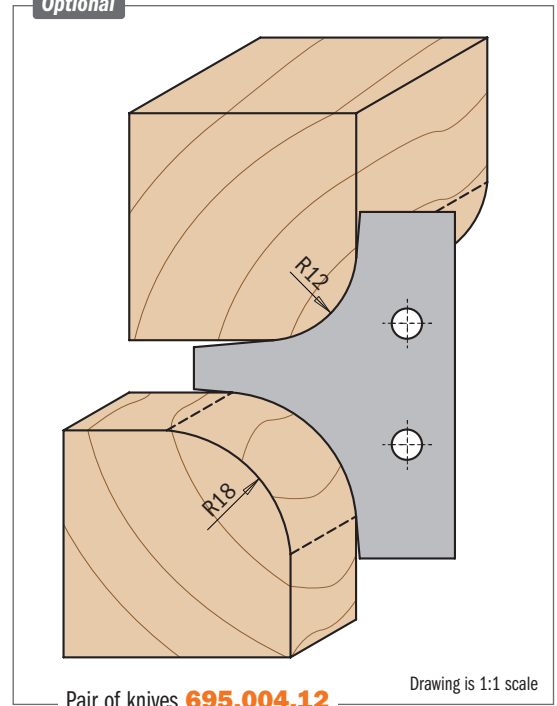

Optional



Pair of knives **695.004.12**

D mm	B mm	Z	RPM		ORDER NO.
132	30	2	5700~9500	1	694.004.30
132	31,75	2	5700~9500	1	694.004.31
132	35	2	5700~9500	1	694.004.35
147	40	2	5100~8500	1	694.004.40
147	50	2	5100~8500	1	694.004.50

Spare parts

 x2			
695.004.15	695.999.42	990.064.00	991.064.00
695.004.15	695.999.42	990.064.00	991.064.00
695.004.15	695.999.42	990.064.00	991.064.00
695.004.15	695.999.42	990.064.00	991.064.00
695.004.15	695.999.42	990.064.00	991.064.00

Optional: **695.004.12** R=12/18mm (45x34,5x2mm) pair of profiled knives



694.007

These cutter heads are perfect for making furniture, doors and drawer fronts simply and stylishly by applying a final touch with a CMT cove bit. It is also used for making perfect roundover profiles, drop leaf counters and table tops. You can use three different knives for carrying out roundover and cove profiles with 10, 12 and 15mm radii. For use on spindle moulder machines, moulder and shaping machines. Suitable for all materials, but ideal on solid wood and panel materials.

TECHNICAL DETAILS:

- Hard aluminium alloy body with high resistance to tensile and yield stress.
- 2 HWM knives radius 10mm (34,8x29,3x2mm) [Z2].
- Tools for manual feed (MAN).
- Pins for the automatic positioning of the knives.



Supplied in a sturdy plastic carry case

SAFETY TIPS



The **TW-006** Torque Screwdriver is recommended for the proper fastening of screws (see page 413).

Standard

Pair of knives **695.007.10**

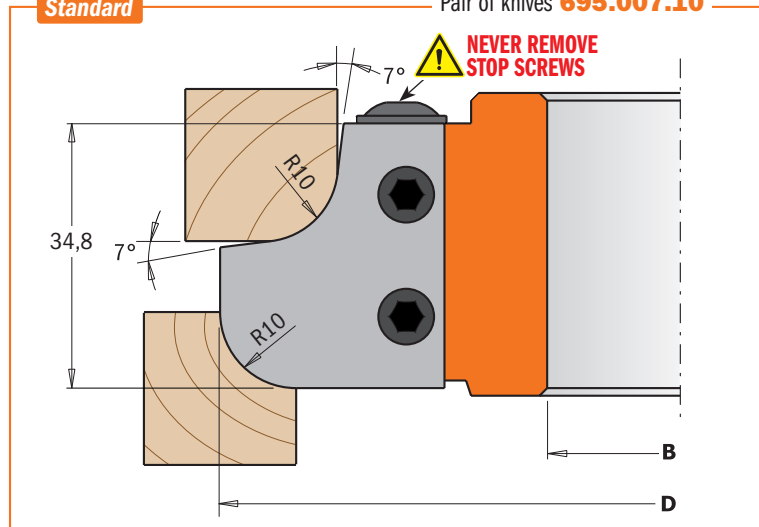

Optional

Pair of knives **695.007.12**

Pair of knives **695.007.15**

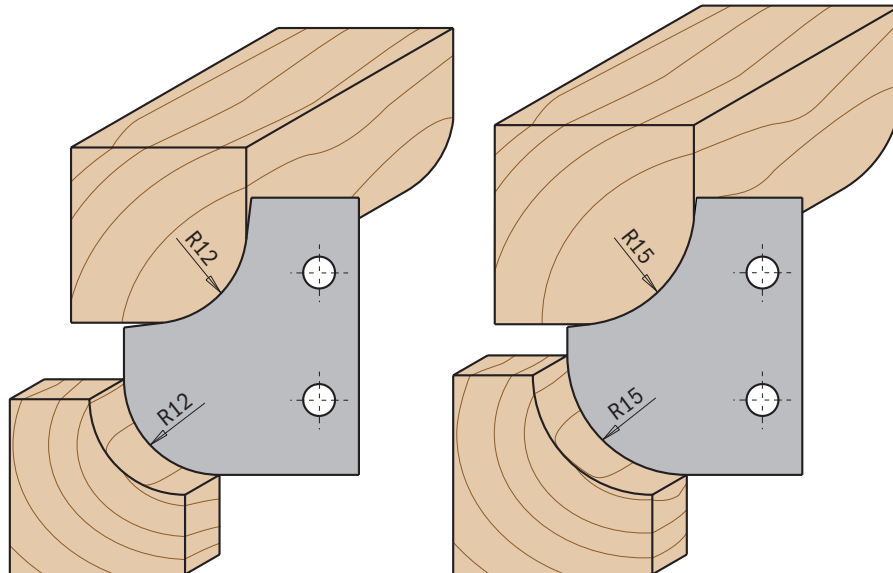

Drawing is 1:1 scale

D mm	B mm	Z	RPM		ORDER NO.
121	30	2	6300~10500	1	694.007.30
121	31,75	2	6300~10500	1	694.007.31
121	35	2	6300~10500	1	694.007.35
136	40	2	5100~8500	1	694.007.40
136	50	2	5100~8500	1	694.007.50

Spare parts

x2			
695.007.10	695.999.31	990.064.00	991.064.00
695.007.10	695.999.31	990.064.00	991.064.00
695.007.10	695.999.31	990.064.00	991.064.00
695.007.10	695.999.31	990.064.00	991.064.00
695.007.10	695.999.31	990.064.00	991.064.00

Optional: **695.007.12** R=12mm (34,8x29,3x2mm) pair of roundover/cove knives
695.007.15 R=15mm (34,8x29,3x2mm) pair of roundover/cove knives

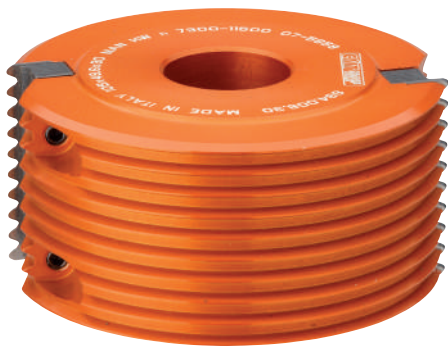

694.008



The CMT professional finger joint cutter head makes the strongest side-to-side joints on all wood types and composites. The tightness of the joint and the maximum surface area for glue application ensure that the joint itself is stronger than an unworked piece of wood. Maximum thickness 47mm.

For use on spindle moulder machines. Perfect for moulding and furniture specialists. Suitable for all materials, but ideal on hard wood and wood panels.

TECHNICAL DETAILS:

- Hard aluminium alloy body with high resistance to tensile and yield stress.
- 2 HWM knives 49,6x11,9x1,5mm [Z2].
- Tools for manual feed (MAN).
- Pins for the automatic positioning of the knives.



Supplied in a sturdy plastic carry case

SAFETY TIPS



The **TW-006** Torque Screwdriver is recommended for the proper fastening of screws (see page 413).

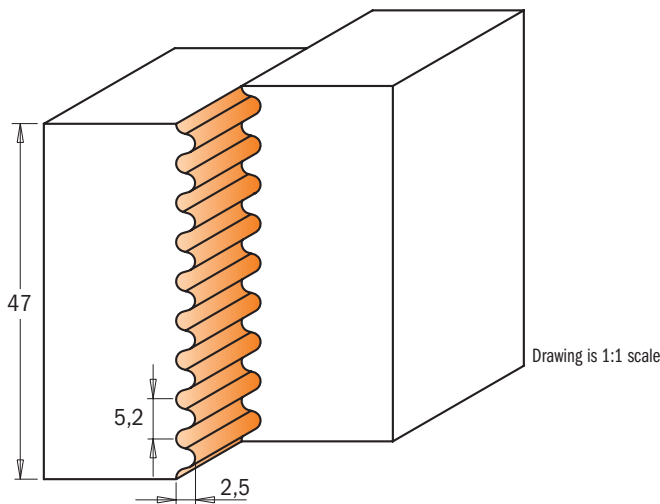
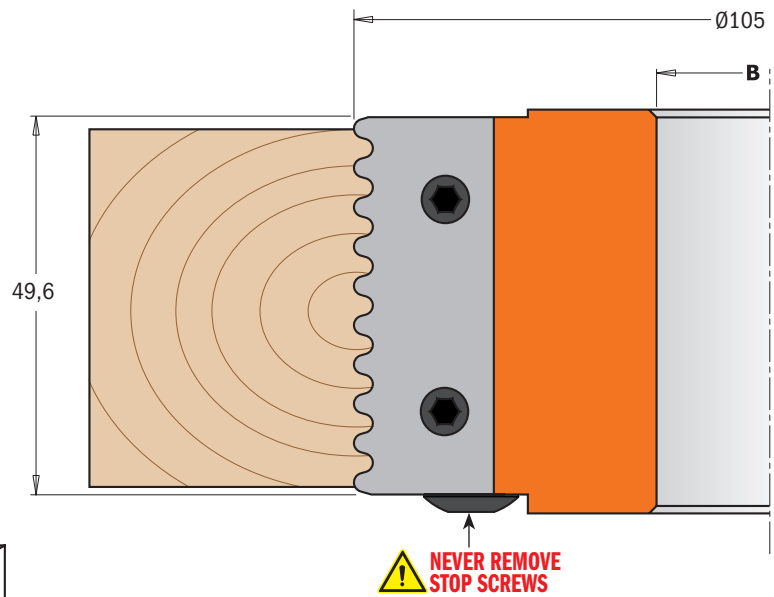

D mm	B mm	Z	RPM		ORDER NO.
105	30	2	7300~11500	1	694.008.30
105	31,75	2	7300~11500	1	694.008.31
105	35	2	7300~11500	1	694.008.35
105	40	2	7300~11500	1	694.008.40
105	50	2	7300~11500	1	694.008.50

Spare parts

695.008.01 x2	695.999.49	990.066.00	991.067.00
695.008.01	695.999.49	990.066.00	991.067.00
695.008.01	695.999.49	990.066.00	991.067.00
695.008.01	695.999.49	990.066.00	991.067.00
695.008.01	695.999.49	990.066.00	991.067.00

- Optional:**
- 695.998.2630** Ø50x2,6x30mm guide ring
 - 695.998.2631** Ø50x2,6x31,75mm guide ring
 - 695.998.2635** Ø55x2,6x35mm guide ring
 - 695.998.2640** Ø60x2,6x40mm guide ring
 - 695.998.2650** Ø70x2,6x50mm guide ring



694.009

One of the unique characteristics of this CMT cutter head is its capacity to craft indestructible glue joints both quickly and accurately. Ideal for shaping panels, doors and furniture pieces of wide proportion. Simply run one side of the panel, turn the panel over, and then run the opposite side. The result? Perfectly harmonized reverse cuts which match up to produce a flawless joint. Excellent for most materials, but ideal on hard wood, and wood panels.

For spindle moulder machines and double-end tenoners.

TECHNICAL DETAILS:

- Hard aluminium alloy body with high resistance to tensile and yield stress.
- 2 HWM knives 40x18x2mm [Z2].
- Tools for manual feed (MAN).
- Pins for the automatic positioning of the knives.



Supplied in a sturdy plastic carry case

SAFETY TIPS



The **TW-006** Torque Screwdriver is recommended for the proper fastening of screws (see page 413).

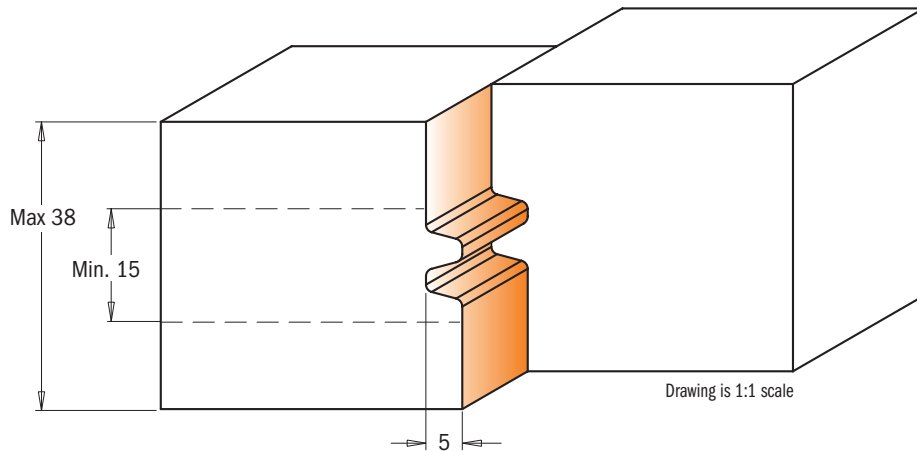
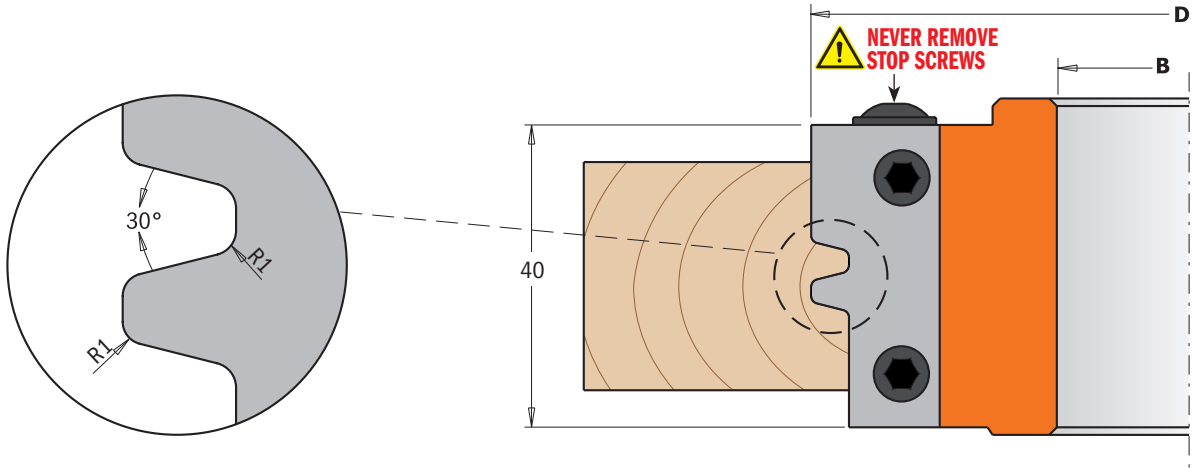

D mm	B mm	Z	RPM		ORDER NO.
100	30	2	7500~12500	1	694.009.30
100	31,75	2	7500~12500	1	694.009.31
100	35	2	7500~12500	1	694.009.35
120	40	2	6400~10500	1	694.009.40
120	50	2	6400~10500	1	694.009.50

Spare parts

x2			
695.009.01	695.999.38	990.064.00	991.064.00
695.009.01	695.999.38	990.064.00	991.064.00
695.009.01	695.999.38	990.064.00	991.064.00
695.009.01	695.999.38	990.064.00	991.064.00
695.009.01	695.999.38	990.064.00	991.064.00



Supplied in a sturdy plastic carry case

694.011



CMT's lock miter cutter heads are ideal for milling miter joints in stock a maximum of 28mm. in thickness. Create boxes, stretcher bars, frames and any assortment of right angle (90°) or parallel joint projects. Two easy steps to produce perfect fitting 45° miter joints: first, position and mill your workpiece horizontally, then vertically.

Create parallel glue joints in two steps: position and mill your workpiece horizontally, internal side facing down, and then turn it facing up. For use on spindle moulder machines and shaper machines. Perfect on all materials, but ideal on solid wood and panels.

TECHNICAL DETAILS:

- Hard aluminium alloy body with high resistance to tensile and yield stress.
- 2 HWM knives 43x23x2mm [Z2].
- Tools for manual feed (MAN).
- Pins for the automatic positioning of the knives.

SAFETY TIPS



The **TW-006** Torque Screwdriver is recommended for the proper fastening of screws (see page 413).

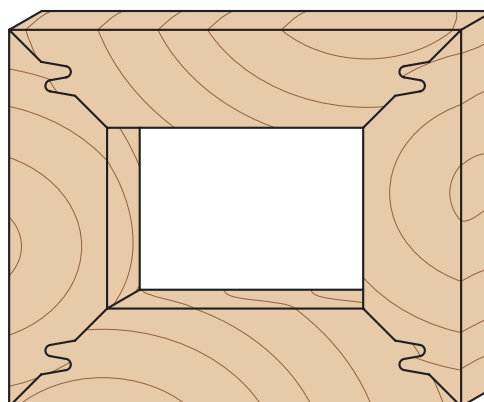
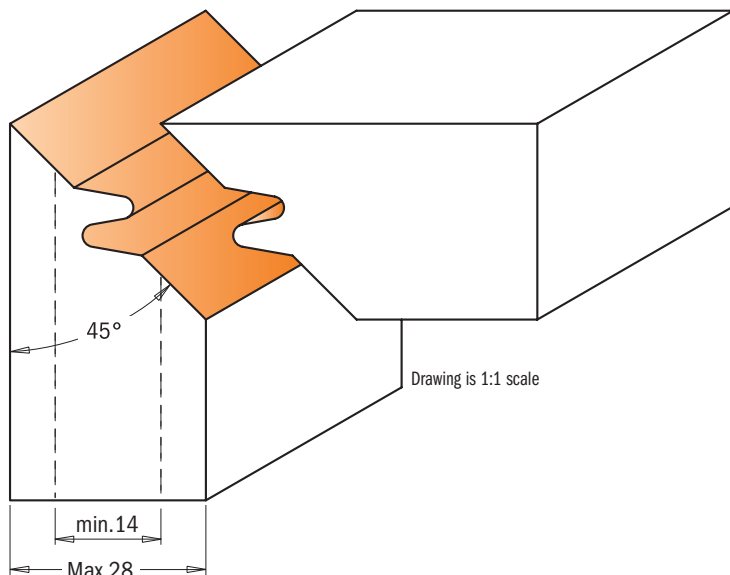
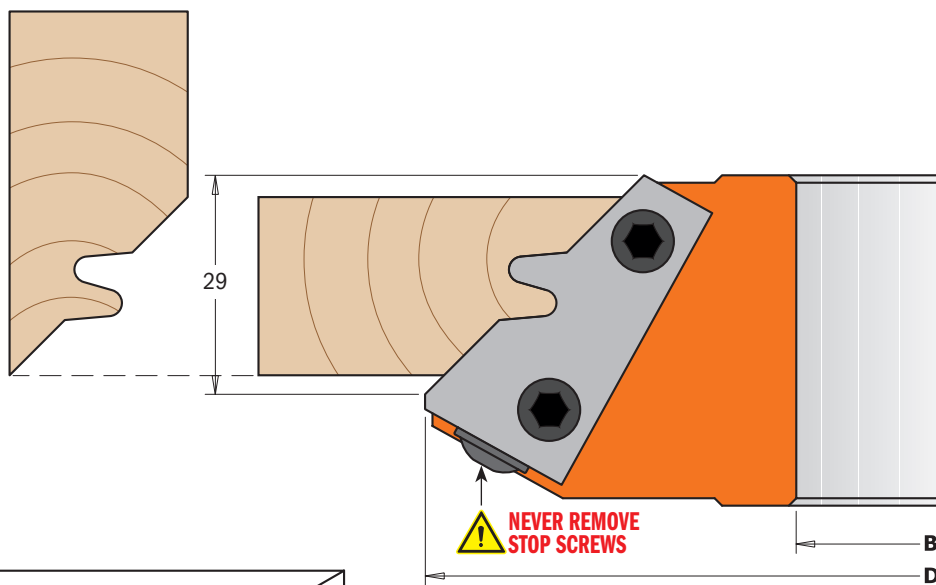

D mm	B mm	Z	RPM		ORDER NO.
140	30	2	5500~9500	1	694.011.30
140	31,75	2	5500~9500	1	694.011.31
140	35	2	5500~9500	1	694.011.35
140	40	2	5500~9500	1	694.011.40
150	50	2	5100~8800	1	694.011.50

Spare parts

x2			
695.011.01	695.999.42	990.064.00	991.064.00
695.011.01	695.999.42	990.064.00	991.064.00
695.011.01	695.999.42	990.064.00	991.064.00
695.011.01	695.999.42	990.064.00	991.064.00
695.011.01	695.999.42	990.064.00	991.064.00

Raised Panel Cutter Heads

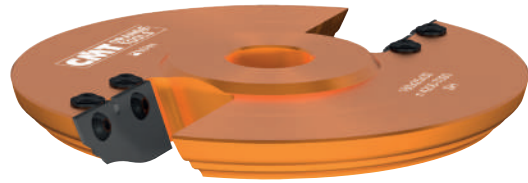

694.012



These new CMT cutter heads will allow you to make classic raised panels on furniture, interior and cabinet doors. An exceptional tool that makes up to six different profiles using the optional knives included. A practical and economical solution. We recommend multiple passes for safe and accurate finishing. For use on spindle moulders and double-end tenoners. Perfect for all materials, but ideal on hard wood and panels.



Supplied in a sturdy plastic carry case

TECHNICAL DETAILS:

- Hard aluminium alloy body with high resistance to tensile and yield stress.
- 2 HWM Knives type (A) 50x25x2mm [Z2].
- Tools for manual feed (MAN)
- Pins for the automatic positioning of the knives.

SAFETY TIPS



The **TW-006** Torque Screwdriver is recommended for the proper fastening of screws (see page 413).

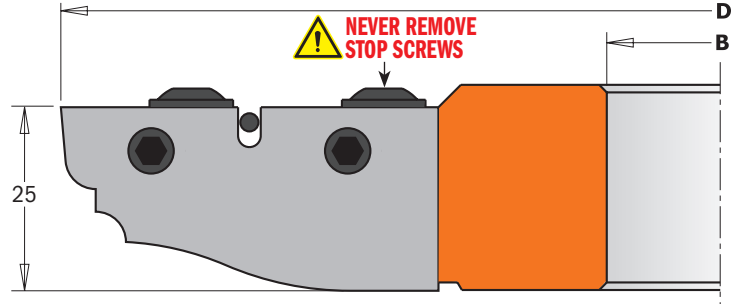

Standard

Pair of knives **695.012A**

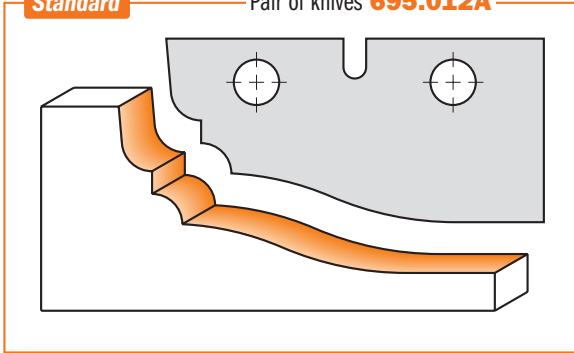

Drawing is 1:1 scale

Optional

Pair of knives **695.012B**

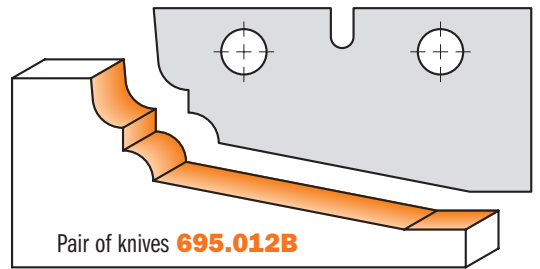

Pair of knives **695.012D**

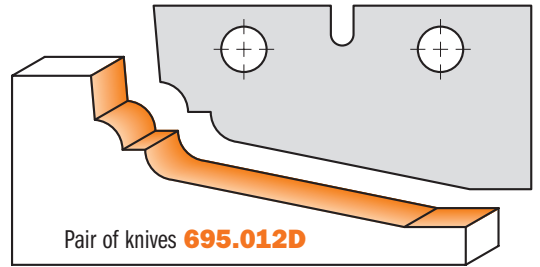

Pair of knives **695.012G**

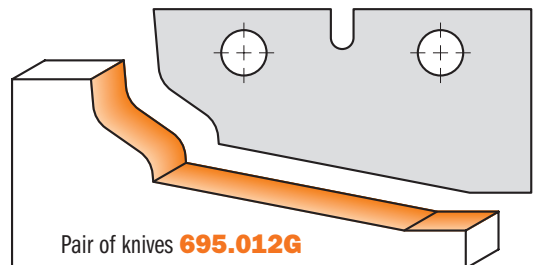

Pair of knives **695.012C**

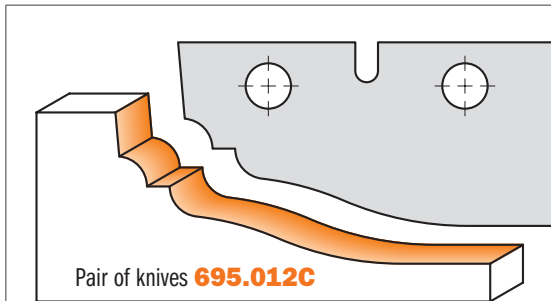

Pair of knives **695.012E**

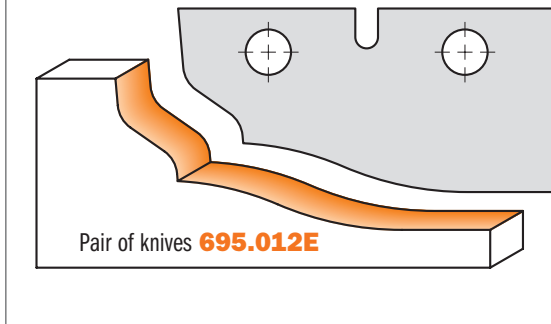

D mm	I mm	B mm	Z	RPM		ORDER NO.
180	25	30	2	4200~7000	1	694.012.30
180	25	35	2	4200~7000	1	694.012.35
180	25	40	2	4200~7000	1	694.012.40
180	25	50	2	4200~7000	1	694.012.50

Spare parts

x2		
695.012A	990.107.00	991.067.00
695.012A	990.107.00	991.067.00
695.012A	990.107.00	991.067.00
695.012A	990.107.00	991.067.00

Optional: **695.012B** 50x25x2mm pair of knives type (B)
695.012C 50x25x2mm pair of knives type (C)
695.012D 50x25x2mm pair of knives type (D)

695.012E 50x25x2mm pair of knives type (E)
695.012G 50x25x2mm pair of knives type (G)



Supplied in a sturdy plastic carry case

694.013



We offer a traditional approach to panel construction with these CMT raised panel cutter heads. Engineered using the most sophisticated technology, it represents a key element in the artisans' workshop. Create classic raised panels on furniture, interior and cabinet doors on solid wood and wooden boards, and achieve three different profiles by adjusting the cutting depth. We recommend multiple passes for safe and accurate finishing.

For use on spindle moulders, moulders, and double-end tenoners. Perfect for all materials, but ideal on hard wood and panels.

TECHNICAL DETAILS:

- Hard aluminium alloy body with high resistance to tensile and yield stress.
- 2 HWM Knives type (A) 19,8x11,9x1,5mm [Z2].
- 2 HWM Knives type (B) 60x11,9x1,5mm [Z2].
- Tools for manual feed (MAN).
- Pins for the automatic positioning of the knives.

SAFETY TIPS



The **TW-006** Torque Screwdriver is recommended for the proper fastening of screws (see page 413).

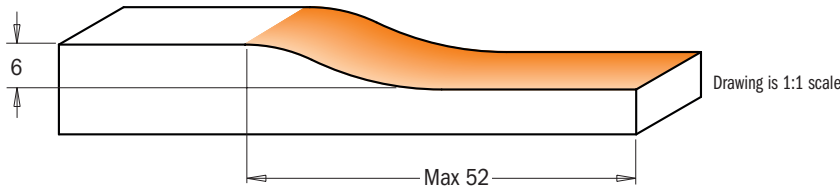
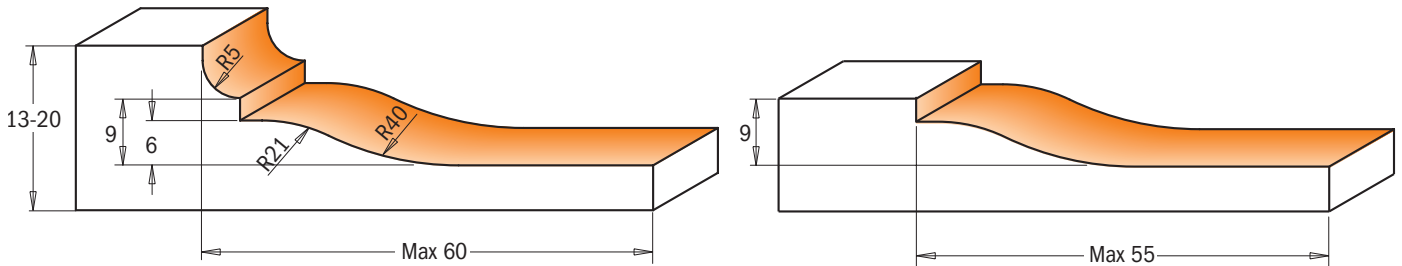
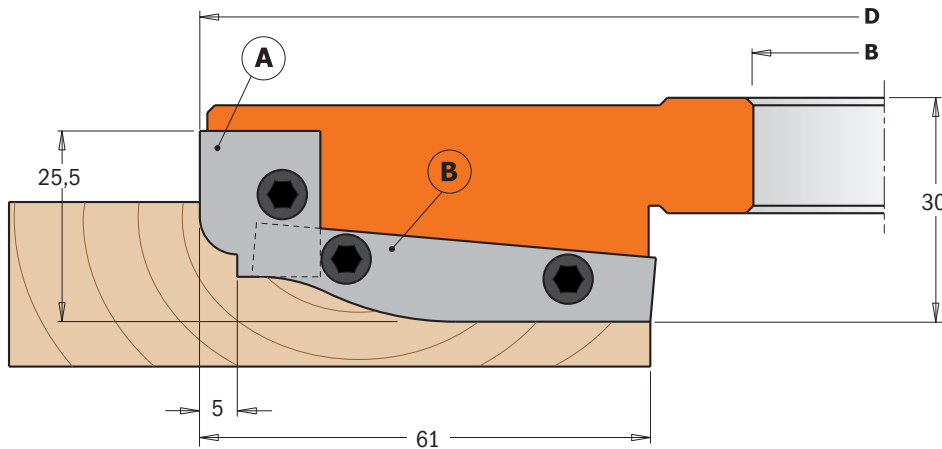

Drawing is 1:1 scale

D mm	B mm	Z	RPM		ORDER NO.
183	30	2+2	4100~7000	1	694.013.30
183	31,75	2+2	4100~7000	1	694.013.31
183	35	2+2	4100~7000	1	694.013.35
200	40	2+2	3800~6400	1	694.013.40
200	50	2+2	3800~6400	1	694.013.50

Spare parts

x2	16x11x9,5mm	x2	53x11x9,5mm	
695.013.A1	695.999.16	695.013.A2	695.999.53	990.066.00
695.013.A1	695.999.16	695.013.A2	695.999.53	990.066.00
695.013.A1	695.999.16	695.013.A2	695.999.53	990.066.00
695.013.A1	695.999.16	695.013.A2	695.999.53	990.066.00
695.013.A1	695.999.16	695.013.A2	695.999.53	990.066.00

Spare parts: **991.083.00** 3x90x135mm hex key



Supplied in a sturdy plastic carry case

694.015

These versatile sets were designed to make furniture and doors on soft and hardwood. It allows the insertion of five different knives to produce the most popular and classical profiles. The adjustable cutter, included in the set, can also be used individually to carry out grooves between 8-15mm. For use on spindle moulders and moulder machines. Perfect on hard wood and panels maximum 22-25mm. in thickness.

TECHNICAL DETAILS:

- Hard aluminium alloy body with high resistance to tensile and yield stress for cutter heads **(1 & 2)**.
- Strength steel body for cutter head **(3)**.
- 2 HWM knives type **(A1)** 25x29,8x2mm [Z2].
- 2 HWM knives type **(A2)** 25x29,8x2mm [Z2].
- 4 HWM knives 7,65x12x1,5mm [Z4].
- 4 HWM knives 14x14x2m for heads type **(1 & 2)**.
- 12 spacer rings from 0,1 to 3mm for heads type **(1 & 2)**.
- 12 spacer rings from 0,1 to 2mm for heads type **(3)**.
- Tools for manual feed (MAN).
- Pins for the automatic positioning of the knives.

SAFETY TIPS



The **TW-006** Torque Screwdriver is recommended for the proper fastening of screws (see page 413).

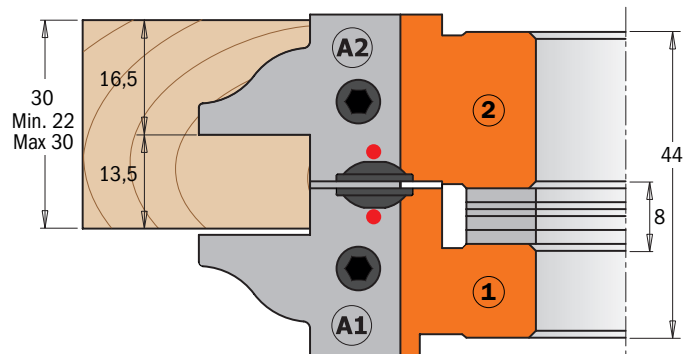
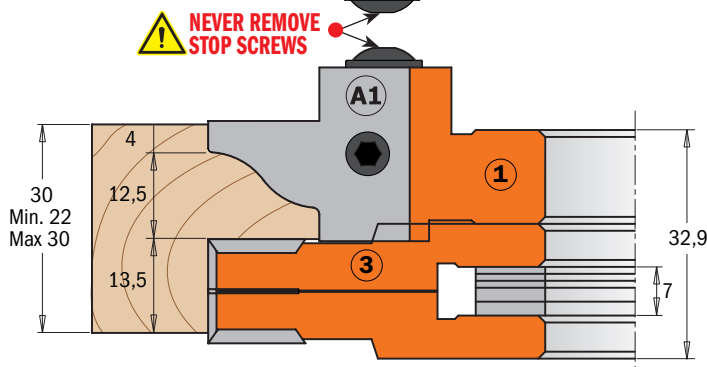
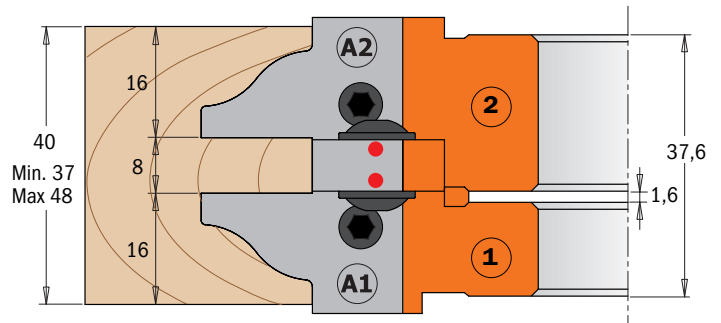
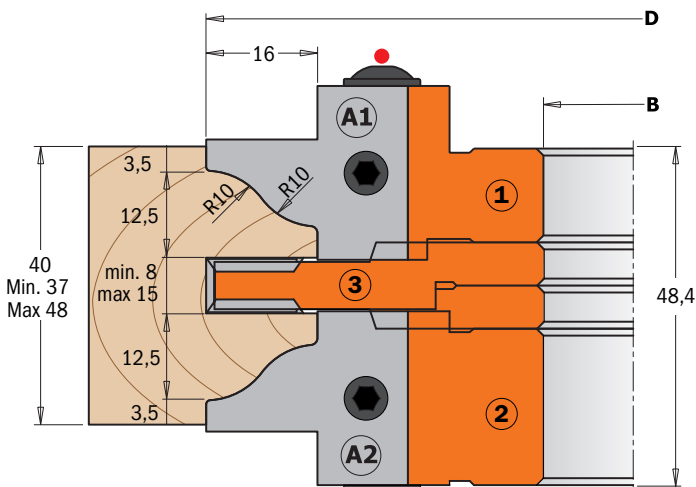

D mm	B mm	Z+V	RPM		ORDER NO.
132	30	2+4	5700~9500	1	694.015.30
132	31,75	2+4	5700~9500	1	694.015.31
132	35	2+4	5700~9500	1	694.015.35
147	40	2+4	5100~8500	1	694.015.40
147	50	2+4	5100~8500	1	694.015.50

Spare parts		Optional
695.998.01	695.998.21	695.998.30
695.998.02	695.998.22	695.998.31
695.998.03	695.998.23	695.998.35
695.998.04	695.998.06	695.998.40
695.998.05	695.998.07	

Spare parts:

Head type (1)

- 695.015.A1 25x29,8x2mm HWM pair of knives (A1)
- 695.015.B1 25x29,8x2mm HWM pair of knives (B1)
- 695.015.C1 25x29,8x2mm HWM pair of knives (C1)
- 695.015.D1 25x29,8x2mm HWM pair of knives (D1)
- 695.015.E1 25x29,8x2mm HWM pair of knives (E1)
- 695.999.23 23x11x9,5mm wedge for knives
- 990.066.00 M6x16mm screw
- 991.067.00 3mm hex key

Head type (2)

- 695.015.A2 25x29,8x2mm HWM pair of knives (A2)
- 695.015.B2 25x29,8x2mm HWM pair of knives (B2)
- 695.015.C2 25x29,8x2mm HWM pair of knives (C2)
- 695.015.D2 25x29,8x2mm HWM pair of knives (D2)
- 695.015.E2 25x29,8x2mm HWM pair of knives (E2)
- 695.999.24 23x11x9,5mm wedge for knives
- 990.066.00 M6x16mm screws
- 991.067.00 3mm hex key

Head type (3)

- 790.076.00* 7,65x12x1,5mm HWM knives
- 695.999.07 6,8x11x9,5mm wedge for knives
- 990.063.00 M5x18mm screw
- 991.072.00 T20 hex key
- 790.140.00* 14x14x2mm HWM Knives
- 990.080.00 M5x6,5mm screw
- 991.073.00 T25 hex key

*Minimum 10 pieces or multiple

Standard

Pair of knives **695.015.A1** - Pair of knives **695.015.A2**

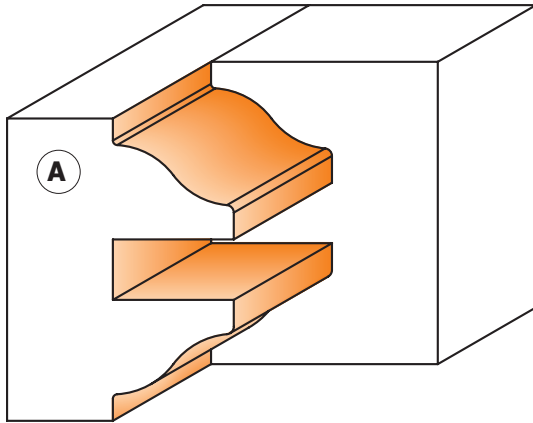

Drawing is 1:1 scale

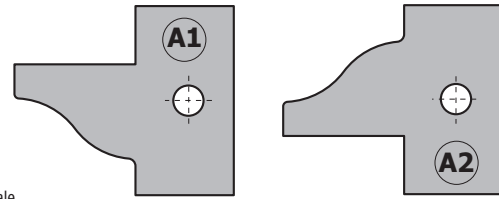

Optional

Pair of knives **695.015.B1**
Pair of knives **695.015.B2**

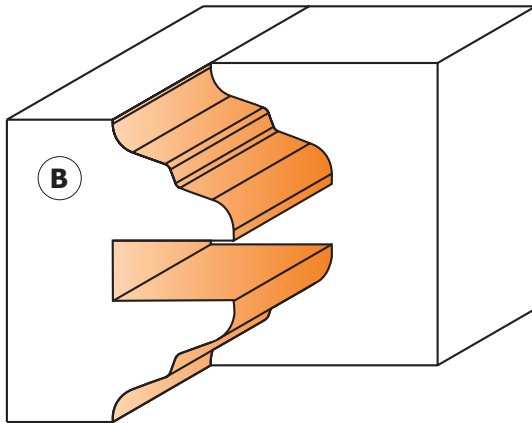
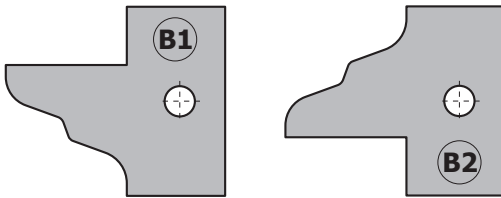

Pair of knives **695.015.C1**
Pair of knives **695.015.C2**

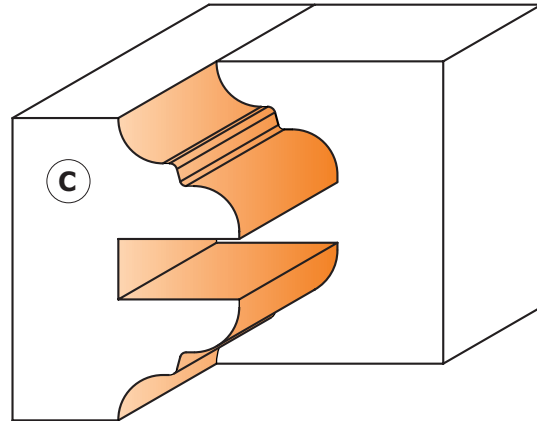
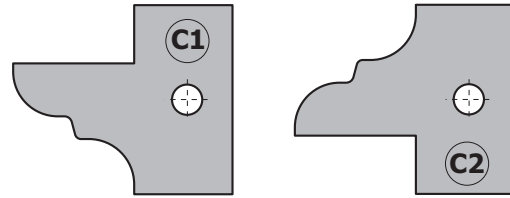

Pair of knives **695.015.D1**
Pair of knives **695.015.D2**

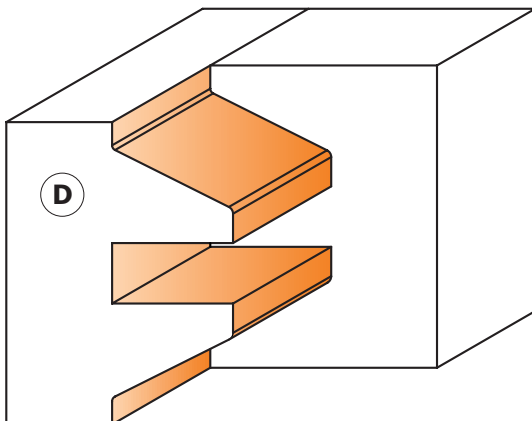
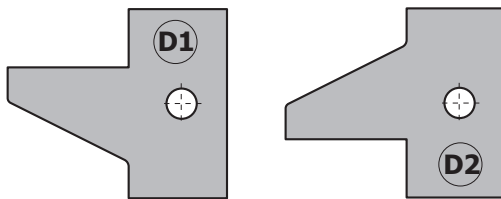

Pair of knives **695.015.E1**
Pair of knives **695.015.E2**

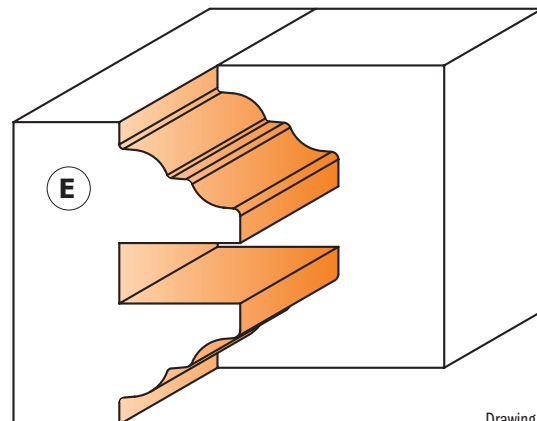
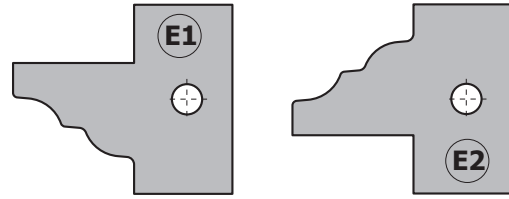

Drawing is 1:1 scale

Rail & Stile Cutter Heads



694.014

These are unique products made by combining two cutter heads, ideal for making furniture doors and drawers. By adjusting the height of the of the cutter head, you can cut two perfectly fitted profiles without wasting time or effort on the fence or replacing the tool. Improve your efficiency and save money only having to purchase one single cutter head!!! For use on spindle moulders. Perfect on hardwood and panels between 22mm-25mm. in thickness.

TECHNICAL DETAILS:

- Hard aluminium alloy body with high resistance to tensile and yield stress.
- 2 HWM knives type (A) 40x24,5x2mm [Z2].
- Tools for manual feed (MAN).
- Pins for the automatic positioning of the knives.

SAFETY TIPS



The **TW-006** Torque Screwdriver is recommended for the proper fastening of screws (see page 413).



Supplied in a sturdy plastic carry case

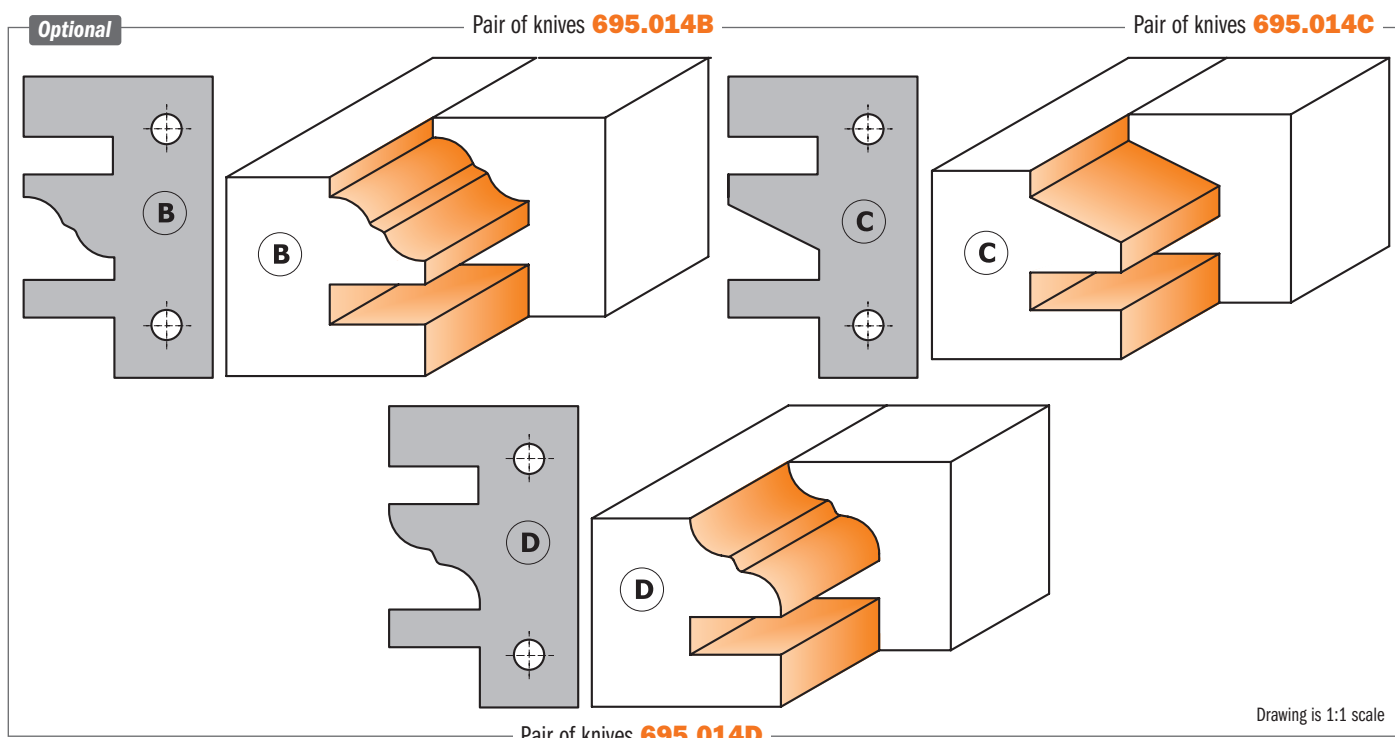
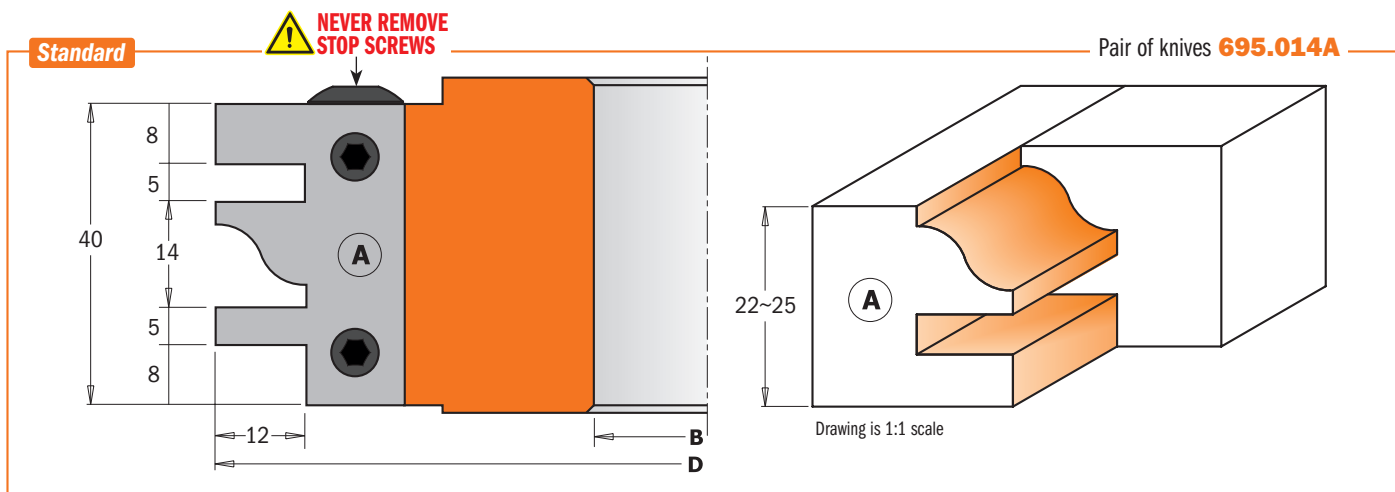

D mm	B mm	Z	RPM		ORDER NO.
120	30	2	6400~10500	1	694.014.30
120	31,75	2	6400~10500	1	694.014.31
120	35	2	6400~10500	1	694.014.35
120	40	2	6400~10500	1	694.014.40
130	50	2	6400~10500	1	694.014.50

Spare parts

695.014A x2	695.999.39	990.066.00	991.067.00
695.014A	695.999.39	990.066.00	991.067.00
695.014A	695.999.39	990.066.00	991.067.00
695.014A	695.999.39	990.066.00	991.067.00
695.014A	695.999.39	990.066.00	991.067.00

Optional: **695.014B** 40x24,5x2mm pair of knives type (B)
695.014C 40x24,5x2mm pair of knives type (C)
695.014D 40x24,5x2mm pair of knives type (D)

Cutter Heads without Limiters



692

CMT cutter heads guarantee excellent performance for all your projects. For use on all types of moulder and spindle moulder machines, profiler and edging machines.



TECHNICAL DETAILS:

- Hard aluminium or steel alloy cutter head without limiters, highly resistant to tensile and yield stress.
- Pair of universal straight knives included.
- Tools for mechanical feed (MEC).
- Pins for the automatic positioning of the knives.
- Possibility to use knives with a height of 40mm or 50mm. (order no. 690).



Supplied in a sturdy plastic carry case. Contains 12 pairs of knives.

SAFETY TIPS

The **TW-006** Torque Screwdriver is recommended for the proper fastening of screws (see page 413).

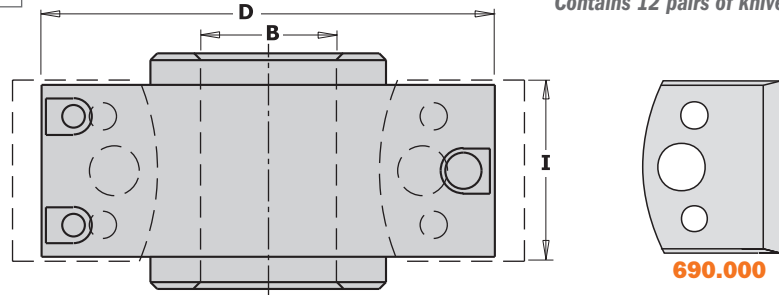
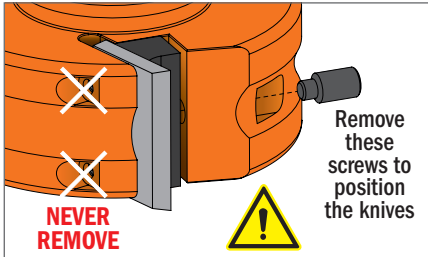

D mm	I mm	B mm	RPM		ORDER NO. Steel body	ORDER NO. Aluminium body
78	40	19,05	7000~9000	1		692.078.19*
78	40	30	7000~9000	1		692.078.30*
100	40-50	25,4	5500~8400	1		692.100.26
100	40-50	30	5500~8400	1	692.101.30	692.100.30
100	40-50	31,75	5500~8400	1		692.100.31
100	40-50	35	5500~8400	1	692.101.35	692.100.35
120	40-50	50	4800~7400	1	692.121.50	692.120.50

Spare parts		
692.999.01	990.064.00	991.064.00
692.999.01	990.064.00	991.064.00
692.999.01	990.064.00	991.064.00
692.999.01	990.064.00	991.064.00
692.999.01	990.064.00	991.064.00
692.999.01	990.064.00	991.064.00
692.999.01	990.064.00	991.064.00
692.999.01	990.064.00	991.064.00

*For safety reasons we recommend the use of knives with a 40mm height only.

Cutter Heads with Limiters



693

CMT cutter heads guarantee excellent performance for all your projects. For use on all types of moulder and spindle moulder machines and moulder machines.



TECHNICAL DETAILS:

- Hard aluminium or steel alloy cutter head with limiters, highly resistant to tensile and yield stress.
- Pair of universal straight knives and limiters included.
- Tools for manual feed (MAN).
- Pins for the automatic positioning of the knives.
- Possibility to use knives with a height of 40mm or 50mm. (order no. 690) and limiters (order no. 691).



Supplied in a sturdy plastic carry case. Contains 12 pairs of knives.

Made in compliance with EU Directive EN 847-1.

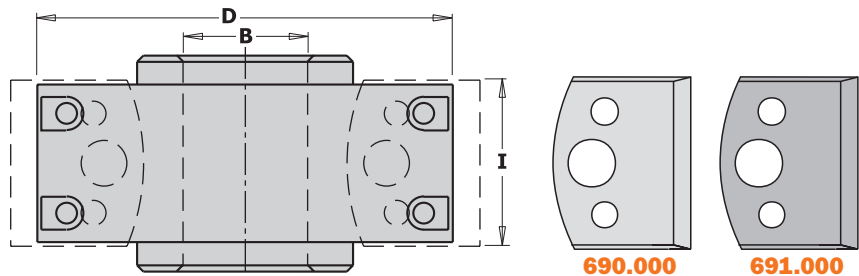
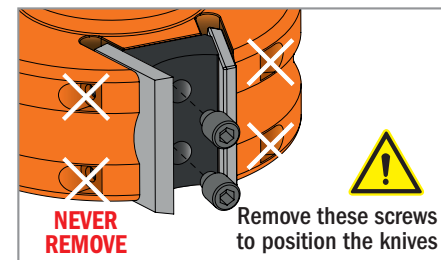

D mm	I mm	B mm	RPM		ORDER NO. Steel body	ORDER NO. Aluminium body
78	40	30	7000~9000	1	693.078.30	
100	40-50	30	5500~8400	1	693.101.30	693.100.30
100	40-50	31,75	5500~8400	1		693.100.31
100	40-50	35	5500~8400	1	693.101.35	693.100.35
120	40-50	50	4800~7400	1	693.121.50	693.120.50

Spare parts		
693.999.01	990.065.00	991.064.00
693.999.01	990.065.00	991.064.00
693.999.01	990.065.00	991.064.00
693.999.01	990.065.00	991.064.00
693.999.01	990.065.00	991.064.00
693.999.01	990.065.00	991.064.00

13 Piece Multiprofile Cutter Head Sets without Limiters



692

This set is ideal for making joints and frames and include 3 essential profiles specifically for creating cabinet doors. An invaluable asset for any professional woodworker. The cutter heads included allow the insertion of knives at a height of either 40mm. or 50mm. Both cutter head and knives are packaged in a sturdy plastic case to prevent damage.

THESE SETS INCLUDE:

- 1 cutter head in hard aluminium alloy with pins for the automatic positioning of the knives.
- 13 pairs of knives with a cutting height of 40mm.

SAFETY TIPS

The **TW-006** Torque Screwdriver is recommended for the proper fastening of screws (see page 413).

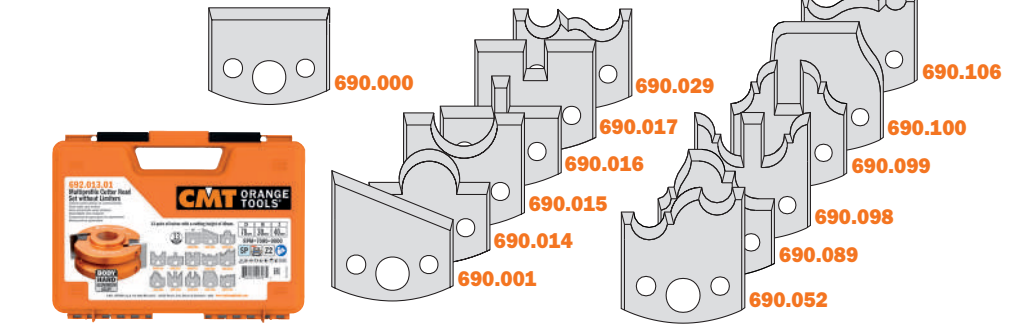
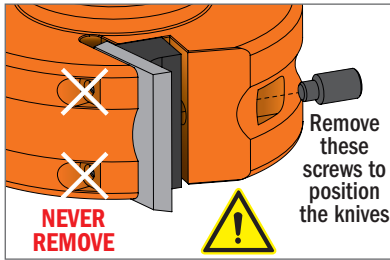

Supplied in a sturdy plastic carry case

D mm	I mm	B mm	RPM		ORDER NO.
78	40	19,05	7000~9000	1	692.013.09
78	40	30	7000~9000	1	692.013.01
100	40	25,4	5500~8400	1	692.013.10
100	40	30	5500~8400	1	692.013.02
100	40	31,75	5500~8400	1	692.013.11
100	40	35	5500~8400	1	692.013.03
120	40	50	4800~7400	1	692.013.04

Spare parts

692.999.01	990.064.00	991.064.00
692.999.01	990.064.00	991.064.00
692.999.01	990.064.00	991.064.00
692.999.01	990.064.00	991.064.00
692.999.01	990.064.00	991.064.00
692.999.01	990.064.00	991.064.00
692.999.01	990.064.00	991.064.00
692.999.01	990.064.00	991.064.00



692

13 of the most popular profiles combined in one sturdy carry case. The featured cutter head fits 40-50mm. knives.

THESE SETS INCLUDE:

- 1 cutter head in hard aluminium alloy with pins for the automatic positioning of the knives.
- 13 pairs of knives with a cutting height of 40mm.

SAFETY TIPS

The **TW-006** Torque Screwdriver is recommended for the proper fastening of screws (see page 413).

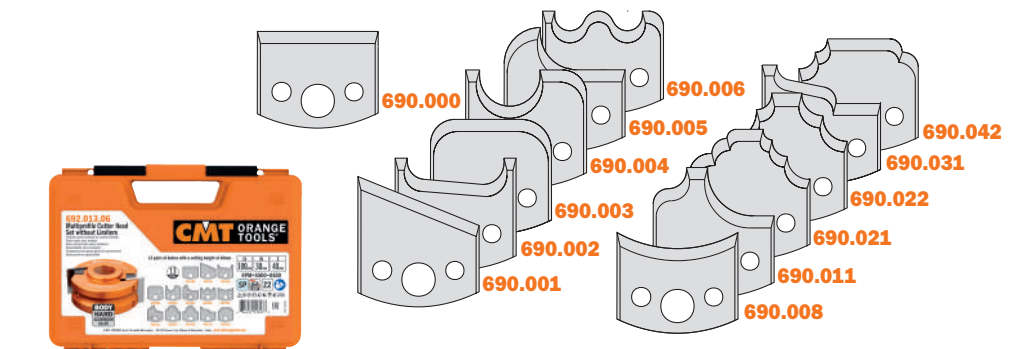
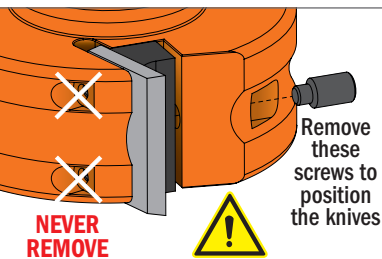

Supplied in a sturdy plastic carry case

D mm	I mm	B mm	RPM		ORDER NO.
78	40	19,05	7000~9000	1	692.013.12
78	40	30	7000~9000	1	692.013.05
100	40	25,4	5500~8400	1	692.013.13
100	40	30	5500~8400	1	692.013.06
100	40	31,75	5500~8400	1	692.013.14
100	40	35	5500~8400	1	692.013.07
120	40	50	4800~7400	1	692.013.08

Spare parts

692.999.01	990.064.00	991.064.00
692.999.01	990.064.00	991.064.00
692.999.01	990.064.00	991.064.00
692.999.01	990.064.00	991.064.00
692.999.01	990.064.00	991.064.00
692.999.01	990.064.00	991.064.00
692.999.01	990.064.00	991.064.00
692.999.01	990.064.00	991.064.00

7 Piece Multiprofile Cutter Head Sets with Limiters



693

CMT has assembled 7 profiles in this convenient set for the professional woodworker; perfect for creating kitchen cabinet doors with a horizontal profile and featuring two pairs of cutters for male-female joints. A specially designed cutter head allows the insertion of knives with a height of either 40mm. or 50mm. The cutter head also boasts safety limiters in keeping with European standards EN 847-1.

THESE SETS INCLUDE:

- 1 cutter head in hard aluminium alloy allowing the insertion of straight knives, limiters and pins for the automatic positioning of the knives.
- 7 pairs of 40mm. knives, as per illustration.
- 7 pairs of relative limiters.

SAFETY TIPS

The **TW-006** Torque Screwdriver is recommended for the proper fastening of screws (see page 413).



Supplied in a sturdy plastic carry case

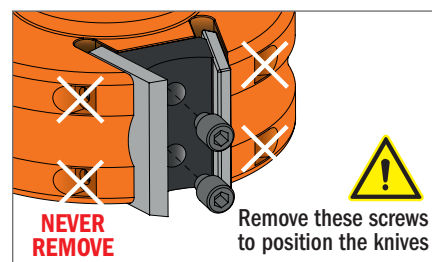
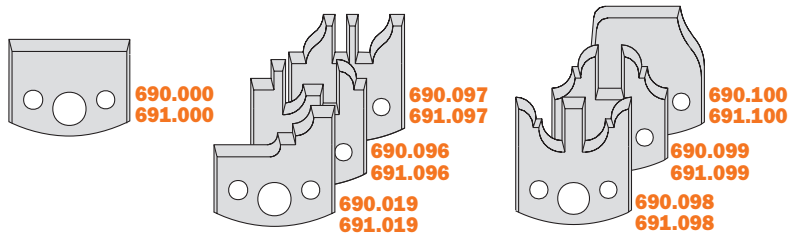

D mm	I mm	B mm	RPM		ORDER NO.
100	40	30	5500~8400	1	693.013.01
100	40	35	5500~8400	1	693.013.02
120	40	50	4800~7400	1	693.013.03

Spare parts

693.999.01	990.065.00	991.064.00
693.999.01	990.065.00	991.064.00
693.999.01	990.065.00	991.064.00

7 Piece Multiprofile Cutter Head Sets with Limiters



693

CMT has assembled the 7 most popular profiles in this practical set conveniently packaged in a sturdy protective carry case. The specially designed cutter head allows the insertion of knives with a height of either 40mm. or 50mm. The cutter head also boasts safety limiters in keeping with European standards EN 847-1.

THESE SETS INCLUDE:

- 1 cutter head in hard aluminium alloy allowing the insertion of straight knives, with limiters and pins for the automatic positioning of the knives.
- 7 pairs of 40mm. knives, as per illustration.
- 7 pairs of relative limiters.

SAFETY TIPS

The **TW-006** Torque Screwdriver is recommended for the proper fastening of screws (see page 413).



Supplied in a sturdy plastic carry case

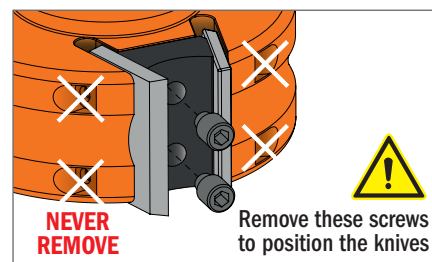
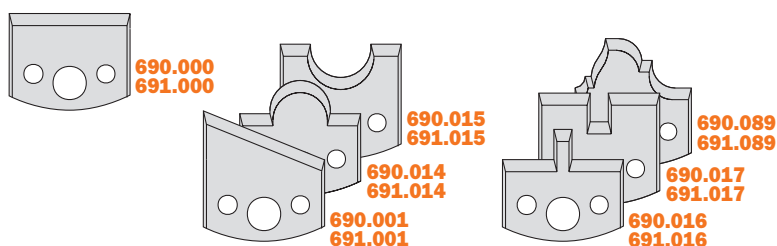

D mm	I mm	B mm	RPM		ORDER NO.
100	40	30	5500~8400	1	693.013.04
100	40	35	5500~8400	1	693.013.05
120	40	50	4800~7400	1	693.013.06

Spare parts

693.999.01	990.065.00	991.064.00
693.999.01	990.065.00	991.064.00
693.999.01	990.065.00	991.064.00

Profile Knives and Limiters

Cutting Length=40mm. Thickness=4mm.

Pack Qty. 10



SP

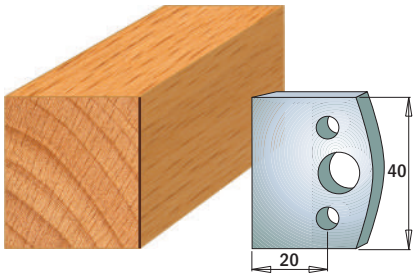

Pair of knives **690.000**
Pair of limiters **691.000**

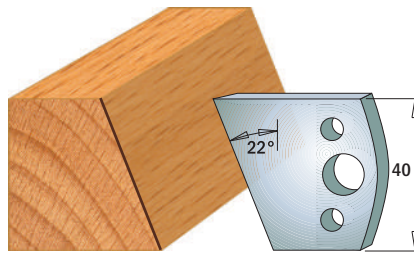

Pair of knives **690.001**
Pair of limiters **691.001**

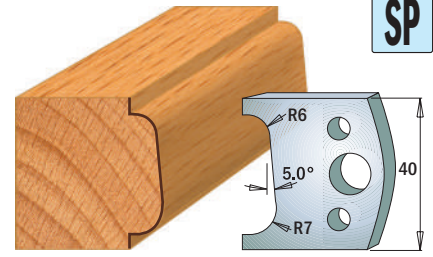

Pair of knives **690.002**
Pair of limiters **691.002**

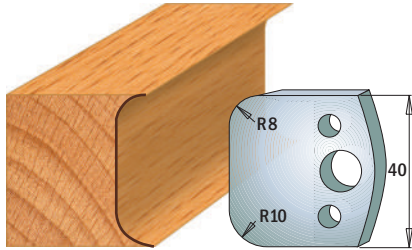

Pair of knives **690.003**
Pair of limiters **691.003**

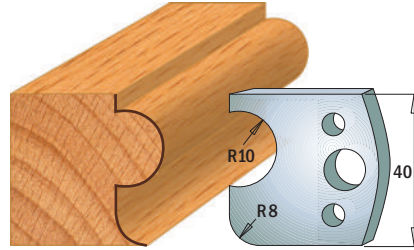

Pair of knives **690.004**
Pair of limiters **691.004**

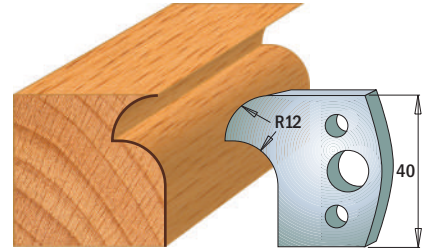

Pair of knives **690.005**
Pair of limiters **691.005**

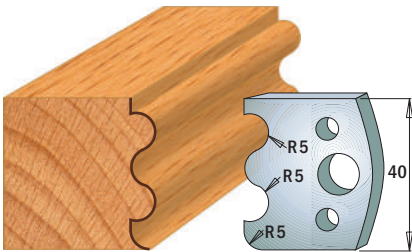

Pair of knives **690.006**
Pair of limiters **691.006**

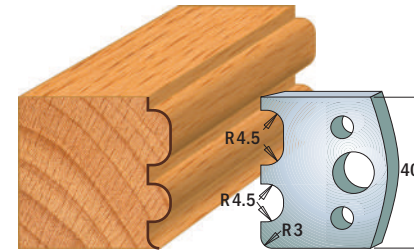

Pair of knives **690.007**
Pair of limiters **691.007**

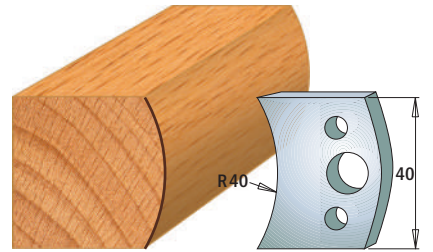

Pair of knives **690.008**
Pair of limiters **691.008**

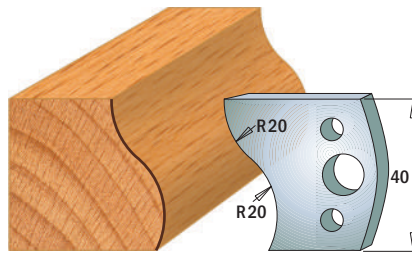

Pair of knives **690.009**
Pair of limiters **691.009**

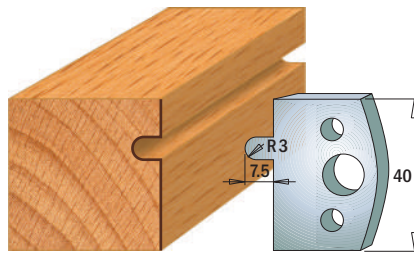

Pair of knives **690.010**
Pair of limiters **691.010**

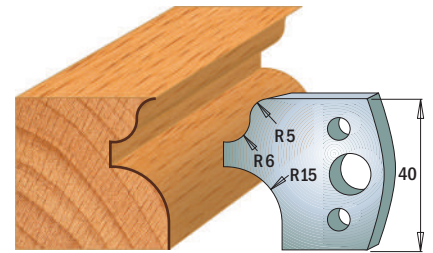

Pair of knives **690.011**
Pair of limiters **691.011**

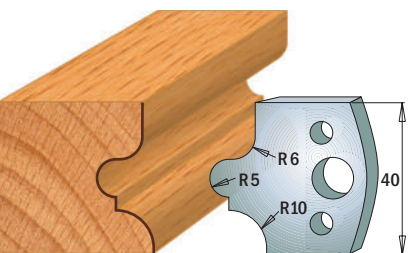

Pair of knives **690.012**
Pair of limiters **691.012**

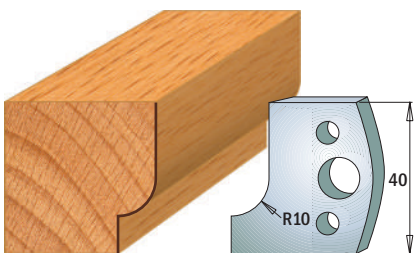

Pair of knives **690.013**
Pair of limiters **691.013**

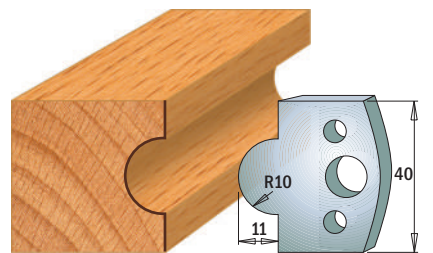

Pair of knives **690.014**
Pair of limiters **691.014**

NOTE: all knives & limiters available only in pairs.
Drawings are 1:2 scale. Dimensions in mm.

Profile Knives and Limiters

Cutting Length=40mm. Thickness=4mm.

Pack Qty. 10



SP

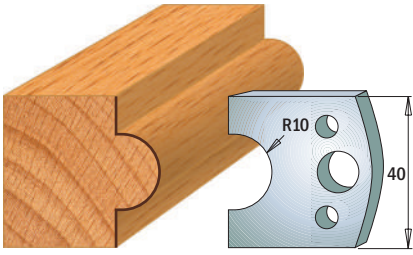

Pair of knives **690.015**
Pair of limiters **691.015**

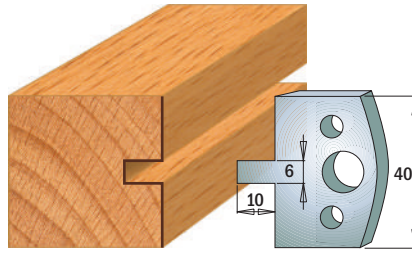

Pair of knives **690.016**
Pair of limiters **691.016**

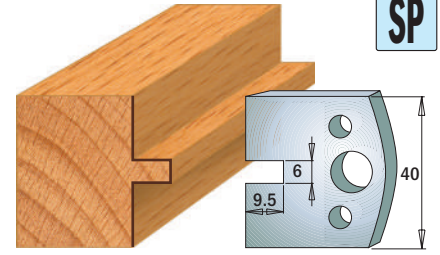

Pair of knives **690.017**
Pair of limiters **691.017**

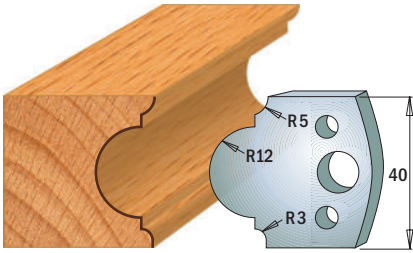

Pair of knives **690.018**
Pair of limiters **691.018**

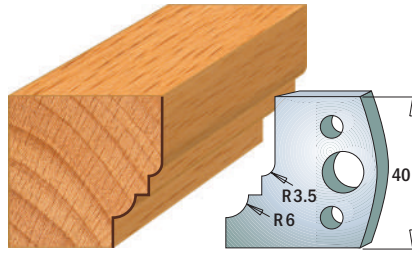

Pair of knives **690.019**
Pair of limiters **691.019**

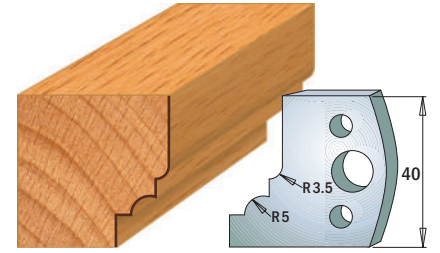

Pair of knives **690.020**
Pair of limiters **691.020**

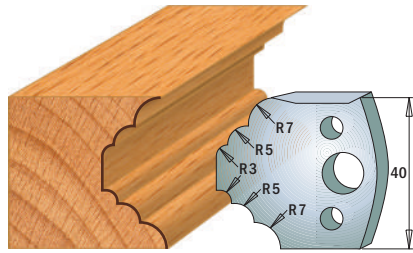

Pair of knives **690.021**
Pair of limiters **691.021**

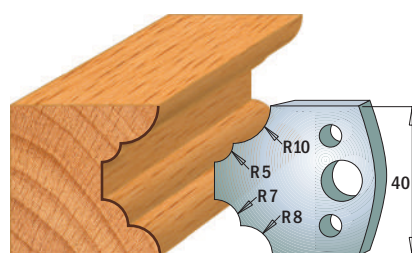

Pair of knives **690.022**
Pair of limiters **691.022**

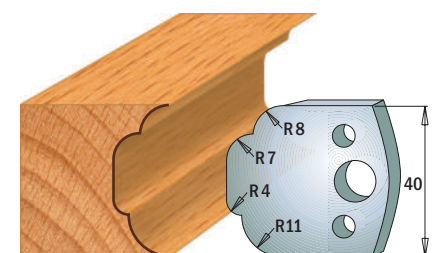

Pair of knives **690.023**
Pair of limiters **691.023**

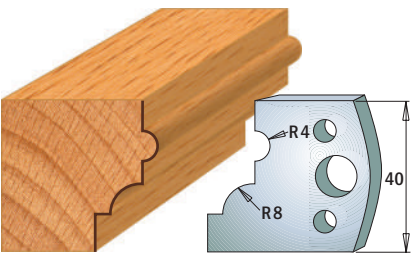

Pair of knives **690.024**
Pair of limiters **691.024**

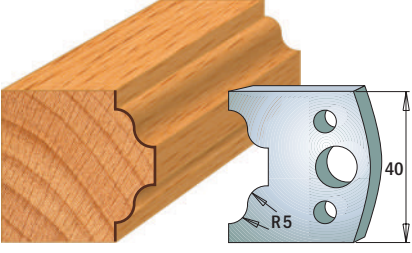

Pair of knives **690.025**
Pair of limiters **691.025**

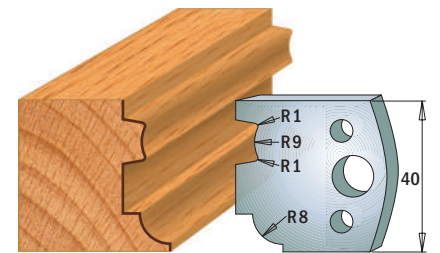

Pair of knives **690.026**
Pair of limiters **691.026**

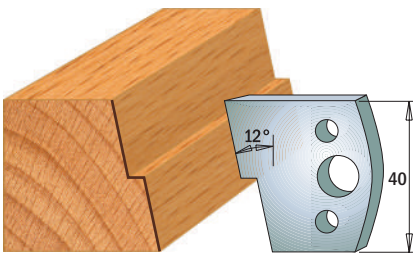

Pair of knives **690.027**
Pair of limiters **691.027**

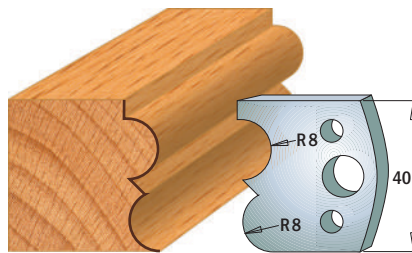

Pair of knives **690.028**
Pair of limiters **691.028**

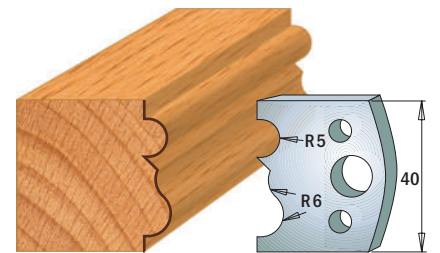

Pair of knives **690.029**
Pair of limiters **691.029**

NOTE: all knives & limiters available only in pairs.
Drawings are 1:2 scale. Dimensions in mm.

Profile Knives and Limiters

Cutting Length=40mm Thickness=4mm

Pack Qty. 10



SP

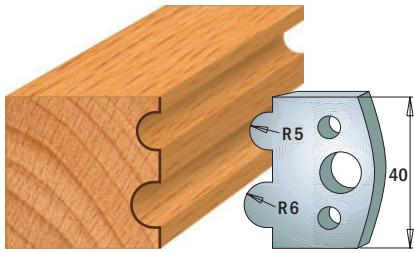

Pair of knives **690.030**
Pair of limiters **691.030**

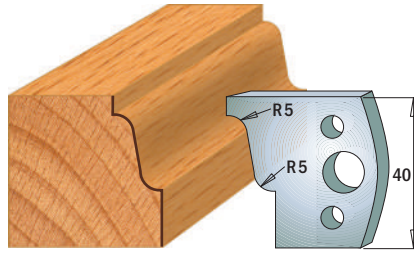

Pair of knives **690.031**
Pair of limiters **691.031**

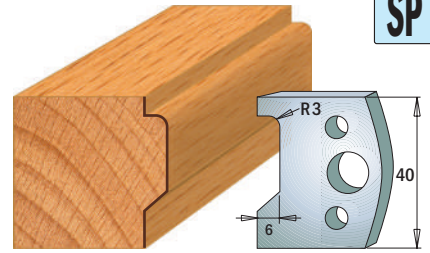

Pair of knives **690.032**
Pair of limiters **691.032**

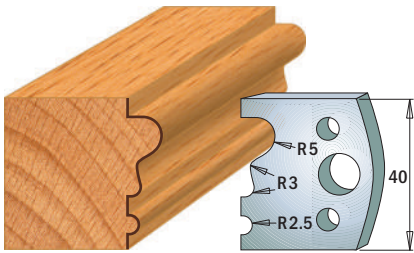

Pair of knives **690.033**
Pair of limiters **691.033**

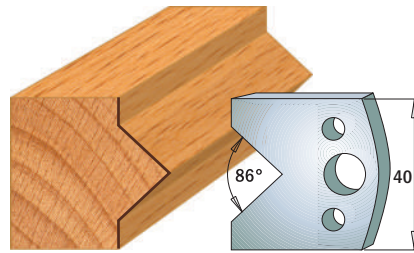

Pair of knives **690.034**
Pair of limiters **691.034**

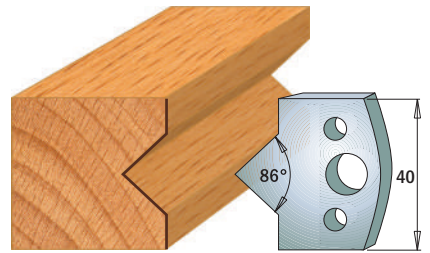

Pair of knives **690.035**
Pair of limiters **691.035**

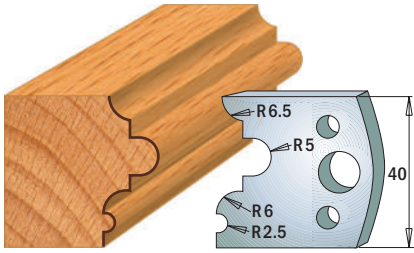

Pair of knives **690.036**
Pair of limiters **691.036**

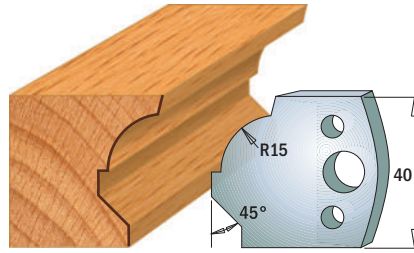

Pair of knives **690.037**
Pair of limiters **691.037**

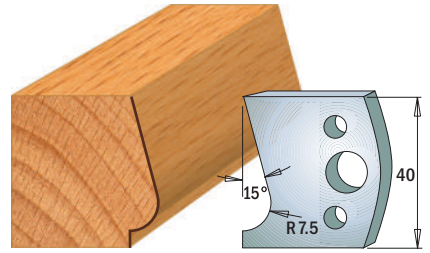

Pair of knives **690.038**
Pair of limiters **691.038**

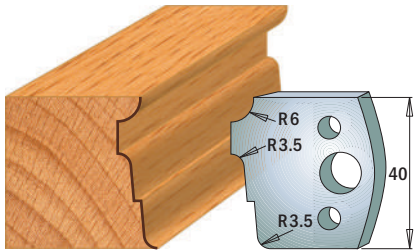

Pair of knives **690.039**
Pair of limiters **691.039**

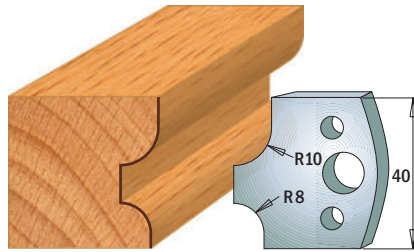

Pair of knives **690.040**
Pair of limiters **691.040**

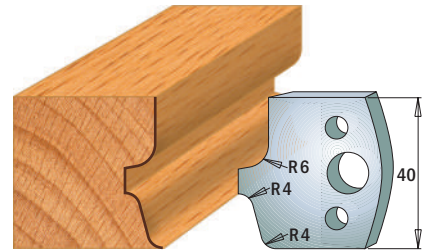

Pair of knives **690.041**
Pair of limiters **691.041**

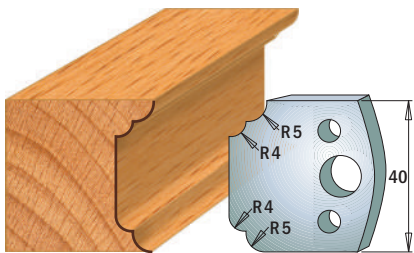

Pair of knives **690.042**
Pair of limiters **691.042**

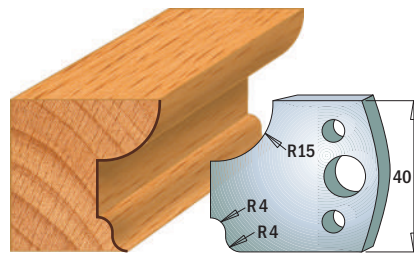

Pair of knives **690.043**
Pair of limiters **691.043**

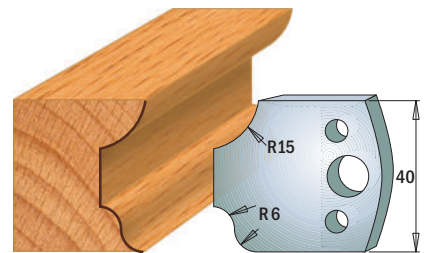

Pair of knives **690.044**
Pair of limiters **691.044**

NOTE: all knives & limiters available only in pairs.
Drawings are 1:2 scale. Dimensions in mm.

Profile Knives and Limiters

Cutting Length=40mm Thickness=4mm

Pack Qty. 10



SP

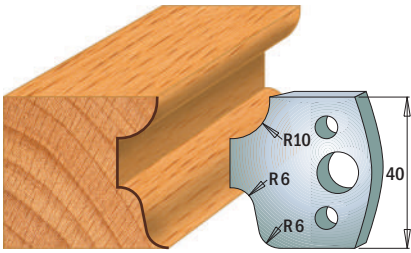

Pair of knives **690.045**
Pair of limiters **691.045**

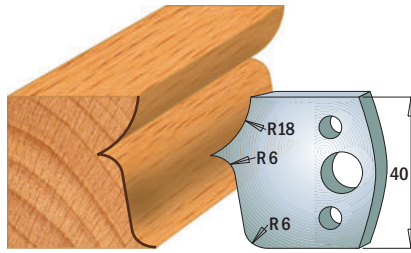

Pair of knives **690.046**
Pair of limiters **691.046**

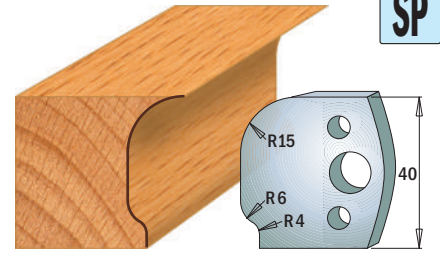

Pair of knives **690.047**
Pair of limiters **691.047**

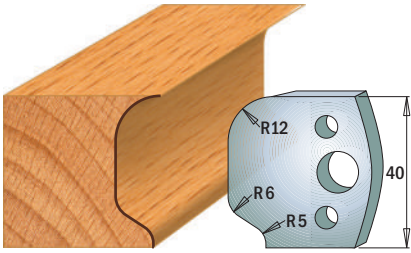

Pair of knives **690.048**
Pair of limiters **691.048**

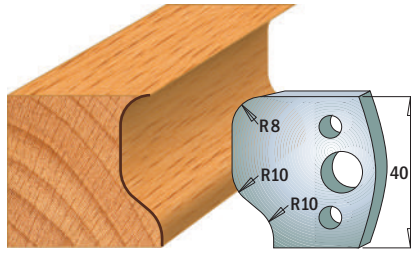

Pair of knives **690.049**
Pair of limiters **691.049**

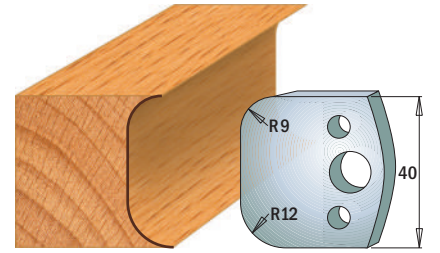

Pair of knives **690.050**
Pair of limiters **691.050**

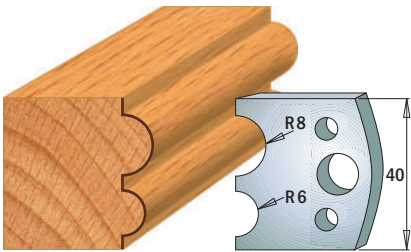

Pair of knives **690.051**
Pair of limiters **691.051**

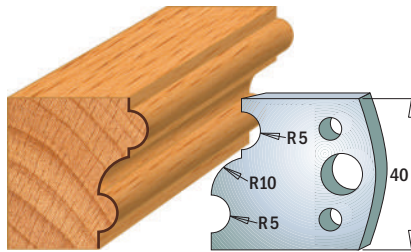

Pair of knives **690.052**
Pair of limiters **691.052**

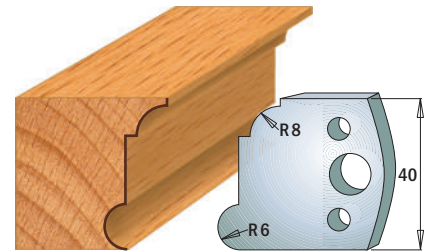

Pair of knives **690.053**
Pair of limiters **691.053**

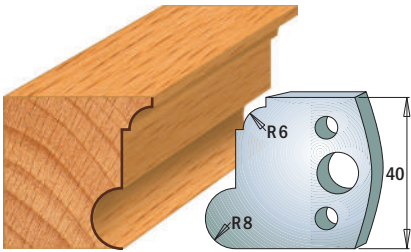

Pair of knives **690.054**
Pair of limiters **691.054**

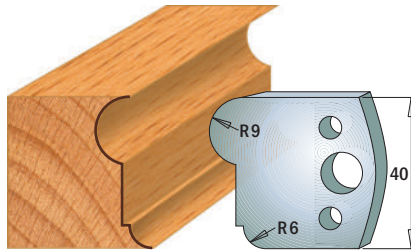

Pair of knives **690.055**
Pair of limiters **691.055**

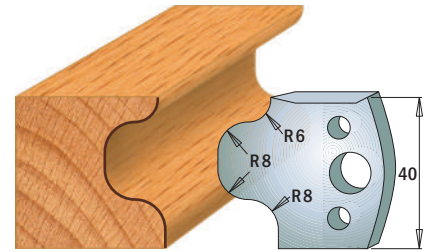

Pair of knives **690.056**
Pair of limiters **691.056**

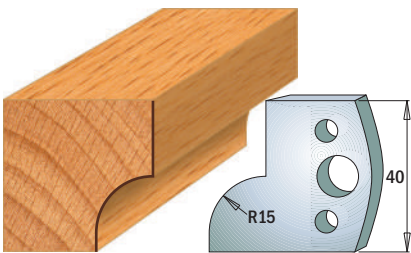

Pair of knives **690.057**
Pair of limiters **691.057**

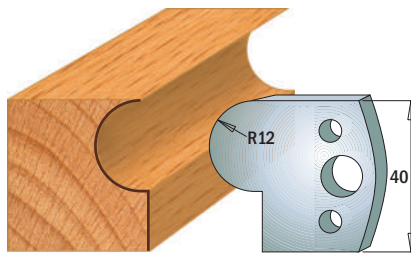

Pair of knives **690.058**
Pair of limiters **691.058**

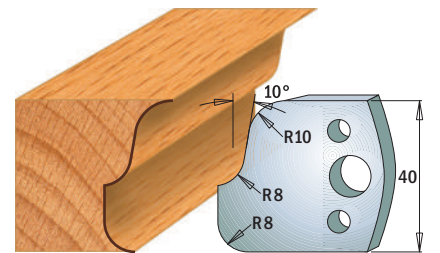

Pair of knives **690.059**
Pair of limiters **691.059**

NOTE: all knives & limiters available only in pairs.
Drawings are 1:2 scale. Dimensions in mm.

Profile Knives and Limiters

Cutting Length=40mm Thickness=4mm

Pack Qty. 10



SP

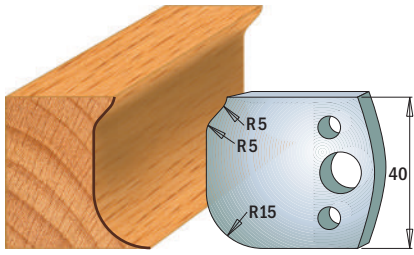

Pair of knives **690.060**
Pair of limiters **691.060**

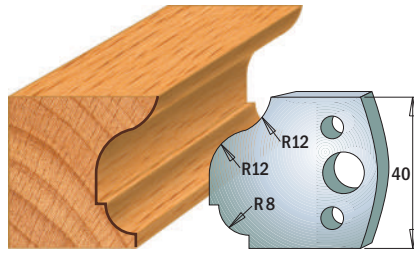

Pair of knives **690.061**
Pair of limiters **691.061**

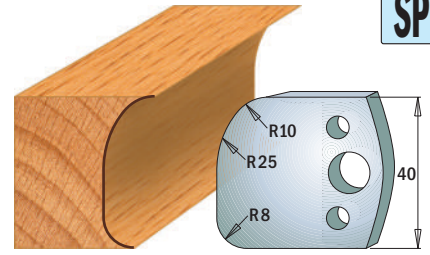

Pair of knives **690.062**
Pair of limiters **691.062**

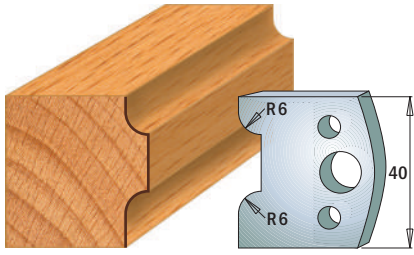

Pair of knives **690.063**
Pair of limiters **691.063**

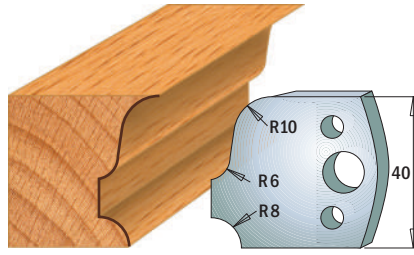

Pair of knives **690.064**
Pair of limiters **691.064**

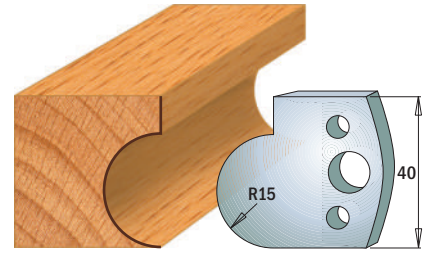

Pair of knives **690.065**
Pair of limiters **691.065**

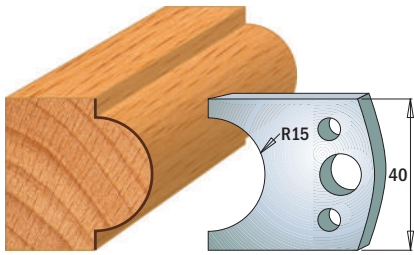

Pair of knives **690.066**
Pair of limiters **691.066**

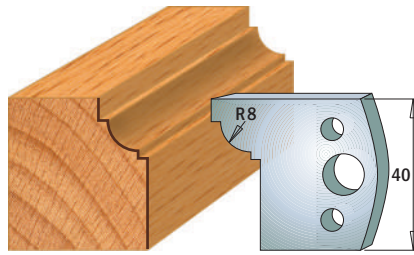

Pair of knives **690.067**
Pair of limiters **691.067**

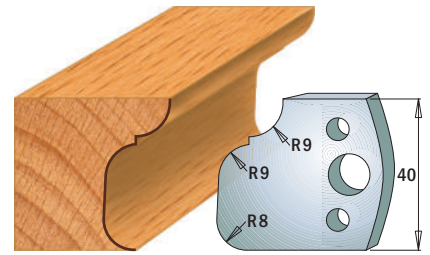

Pair of knives **690.068**
Pair of limiters **691.068**

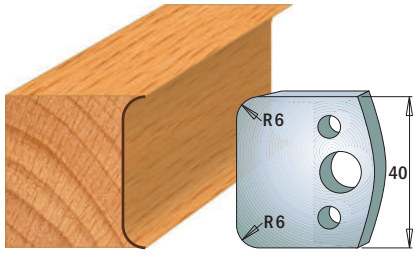

Pair of knives **690.069**
Pair of limiters **691.069**

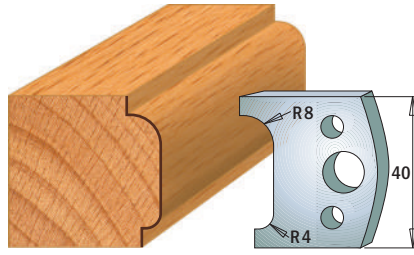

Pair of knives **690.070**
Pair of limiters **691.070**

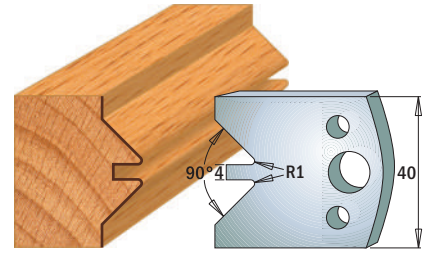

Pair of knives **690.071**
Pair of limiters **691.071**

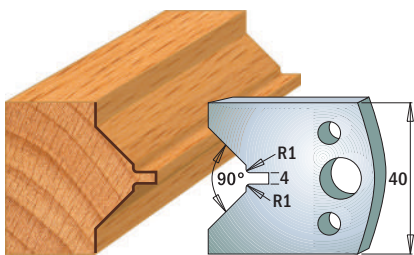

Pair of knives **690.072**
Pair of limiters **691.072**

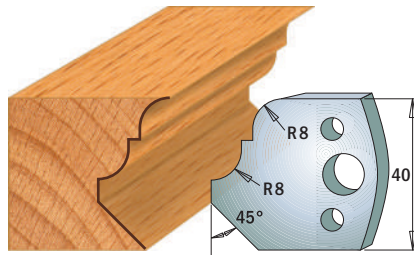

Pair of knives **690.073**
Pair of limiters **691.073**

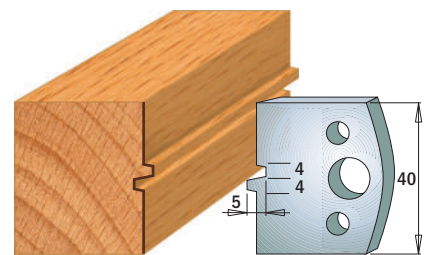

Pair of knives **690.074**
Pair of limiters **691.074**

NOTE: all knives & limiters available only in pairs.
Drawings are 1:2 scale. Dimensions in mm.

Profile Knives and Limiters

Cutting Length=40mm Thickness=4mm

Pack Qty. 10



SP

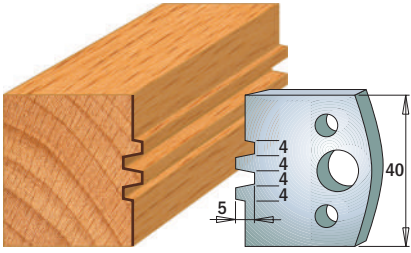

Pair of knives **690.075**
Pair of limiters **691.075**

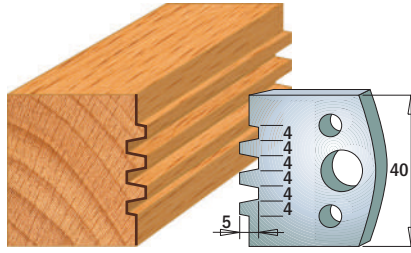

Pair of knives **690.076**
Pair of limiters **691.076**

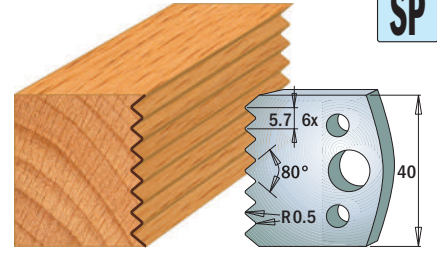

Pair of knives **690.077**
Pair of limiters **691.077**

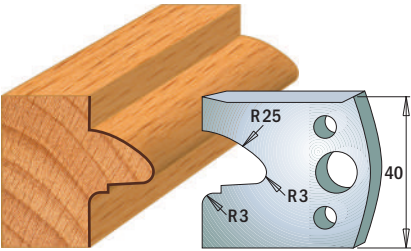

Pair of knives **690.078**
Pair of limiters **691.078**

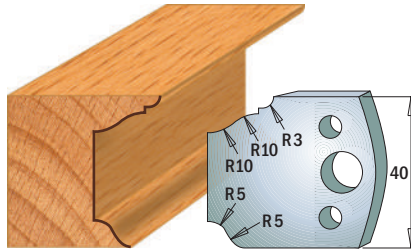

Pair of knives **690.079**
Pair of limiters **691.079**

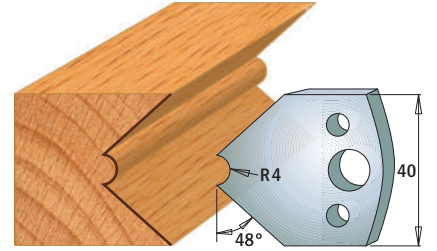

Pair of knives **690.080**
Pair of limiters **691.080**

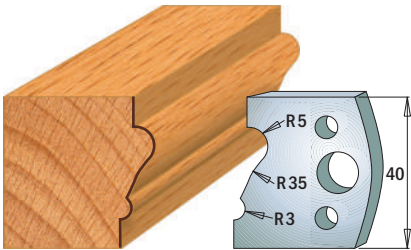

Pair of knives **690.081**
Pair of limiters **691.081**

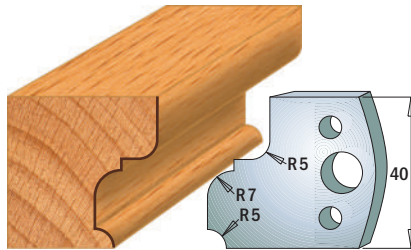

Pair of knives **690.082**
Pair of limiters **691.082**

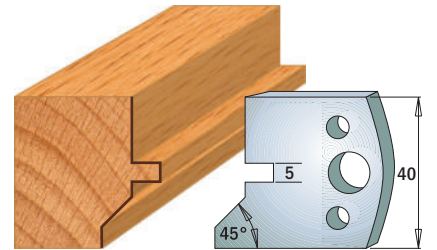

Pair of knives **690.083**
Pair of limiters **691.083**

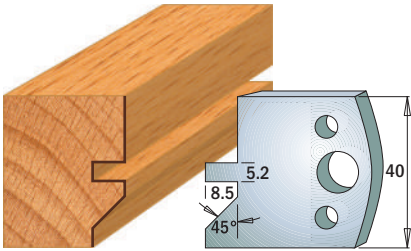

Pair of knives **690.084**
Pair of limiters **691.084**

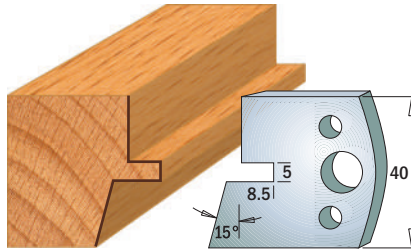

Pair of knives **690.085**
Pair of limiters **691.085**

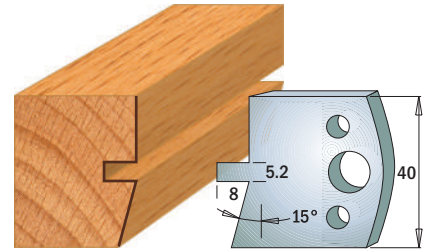

Pair of knives **690.086**
Pair of limiters **691.086**

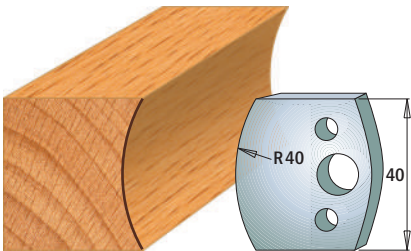

Pair of knives **690.087**
Pair of limiters **691.087**

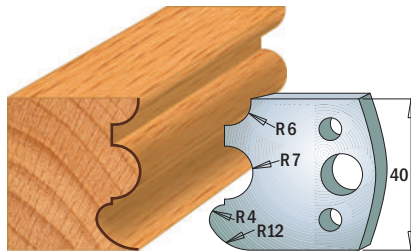

Pair of knives **690.088**
Pair of limiters **691.088**

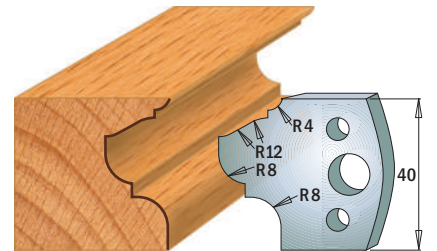

Pair of knives **690.089**
Pair of limiters **691.089**

NOTE: all knives & limiters available only in pairs.
Drawings are 1:2 scale. Dimensions in mm.

Profile Knives and Limiters

Cutting Length=40mm Thickness=4mm

Pack Qty. 10



SP

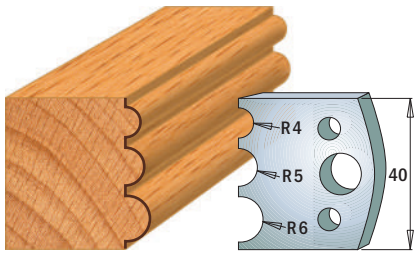

Pair of knives **690.090**
Pair of limiters **691.090**

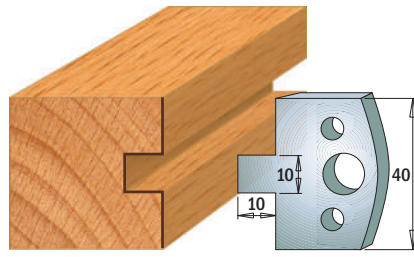

Pair of knives **690.091**
Pair of limiters **691.091**

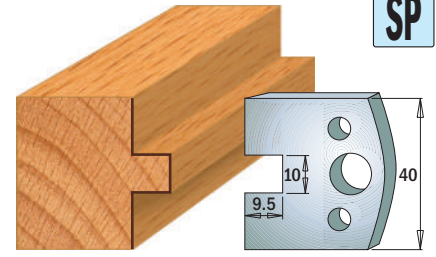

Pair of knives **690.092**
Pair of limiters **691.092**

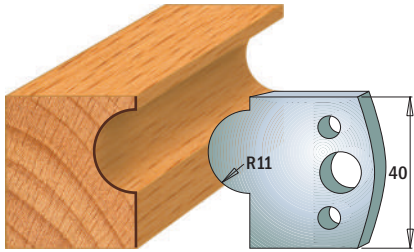

Pair of knives **690.093**
Pair of limiters **691.093**

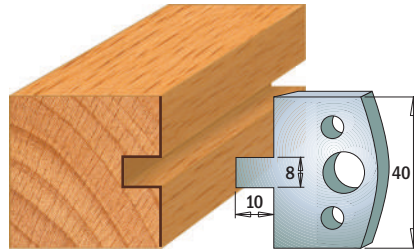

Pair of knives **690.094**
Pair of limiters **691.094**

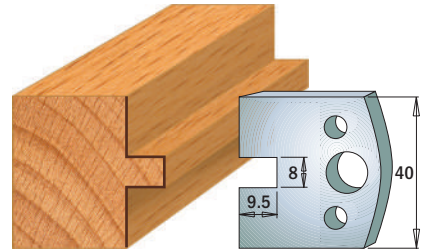

Pair of knives **690.095**
Pair of limiters **691.095**

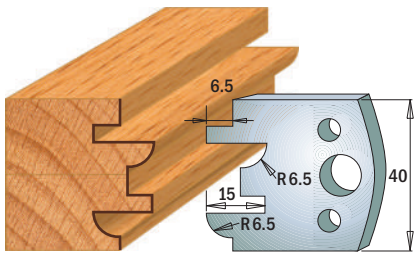

Pair of knives **690.096**
Pair of limiters **691.096**

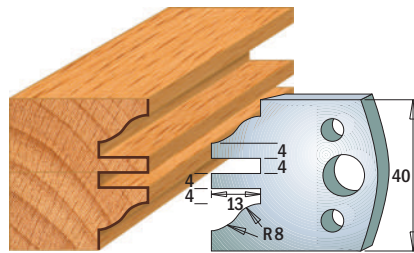

Pair of knives **690.097**
Pair of limiters **691.097**

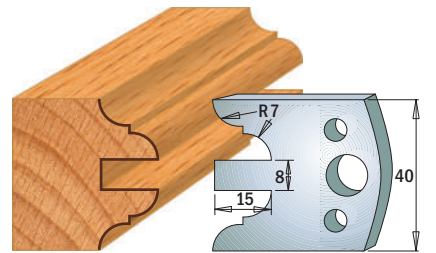

Pair of knives **690.098**
Pair of limiters **691.098**

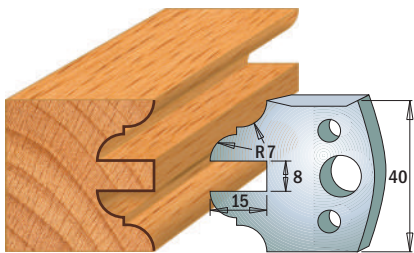

Pair of knives **690.099**
Pair of limiters **691.099**

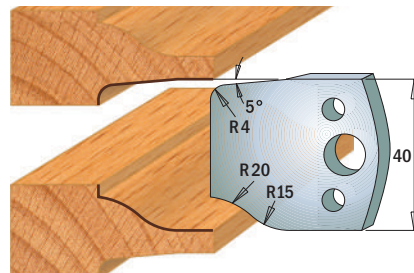

Pair of knives **690.100**
Pair of limiters **691.100**

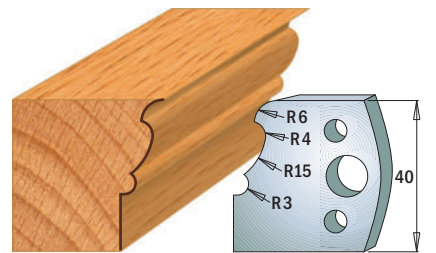

Pair of knives **690.101**
Pair of limiters **691.101**

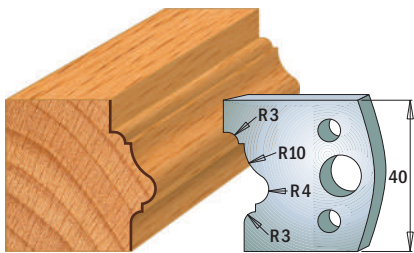

Pair of knives **690.102**
Pair of limiters **691.102**

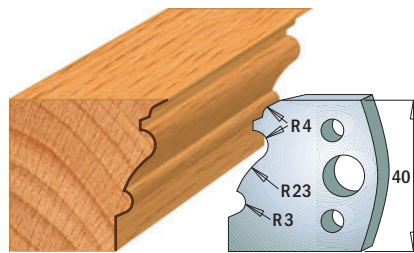

Pair of knives **690.103**
Pair of limiters **691.103**

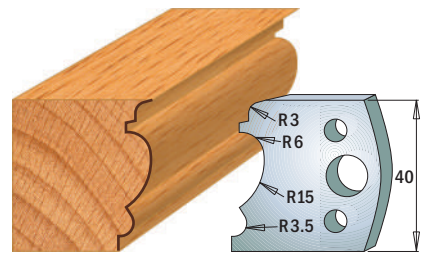

Pair of knives **690.104**
Pair of limiters **691.104**

NOTE: all knives & limiters available only in pairs.
Drawings are 1:2 scale. Dimensions in mm.

Profile Knives and Limiters

Cutting Length=40mm Thickness=4mm

Pack Qty. 10



SP

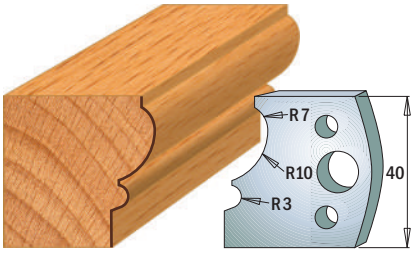

Pair of knives **690.105**
Pair of limiters **691.105**

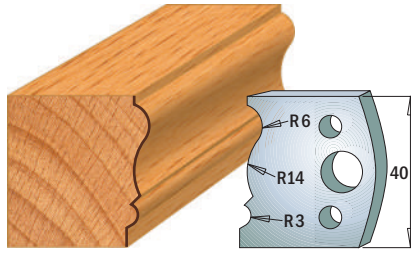

Pair of knives **690.106**
Pair of limiters **691.106**

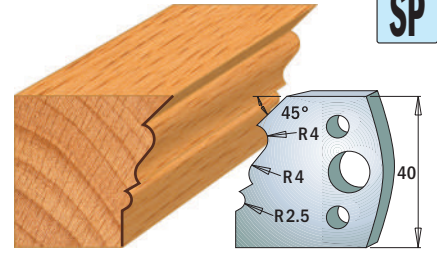

Pair of knives **690.107**
Pair of limiters **691.107**

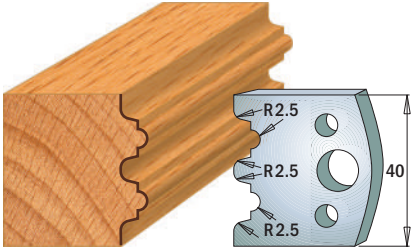

Pair of knives **690.108**
Pair of limiters **691.108**

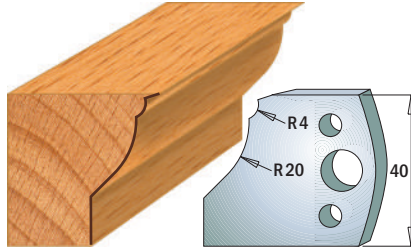

Pair of knives **690.109**
Pair of limiters **691.109**

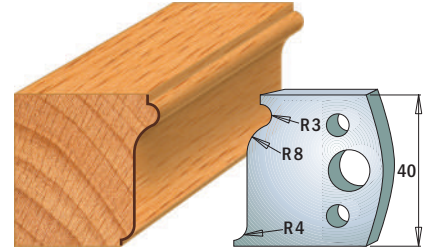

Pair of knives **690.110**
Pair of limiters **691.110**

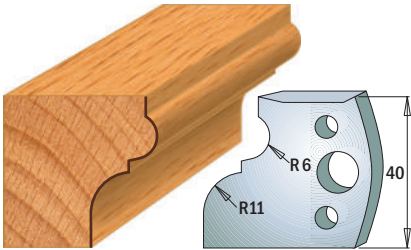

Pair of knives **690.111**
Pair of limiters **691.111**

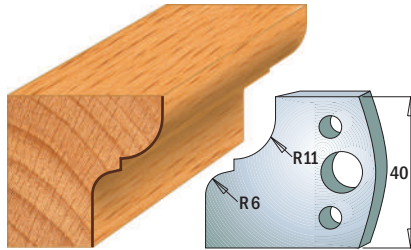

Pair of knives **690.112**
Pair of limiters **691.112**

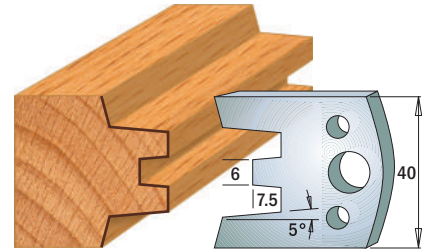

Pair of knives **690.113**
Pair of limiters **691.113**

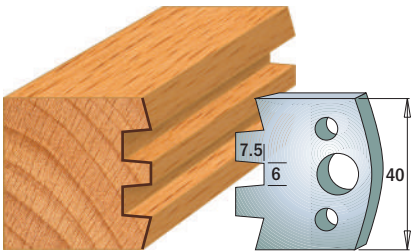

Pair of knives **690.114**
Pair of limiters **691.114**

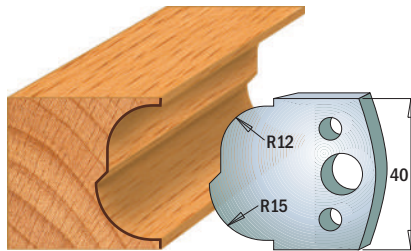

Pair of knives **690.115**
Pair of limiters **691.115**

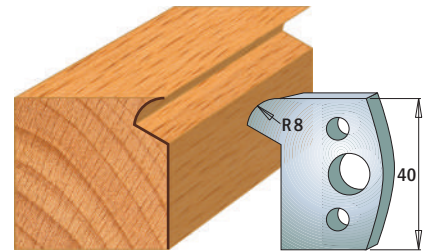

Pair of knives **690.116**
Pair of limiters **691.116**

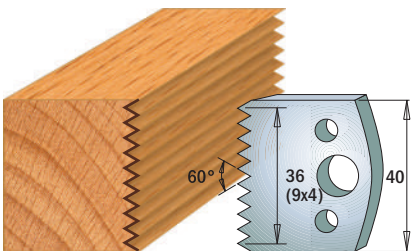

Pair of knives **690.117**
Pair of limiters **691.117**

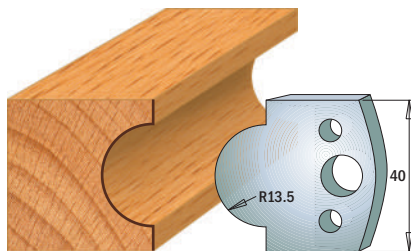

Pair of knives **690.118**
Pair of limiters **691.118**

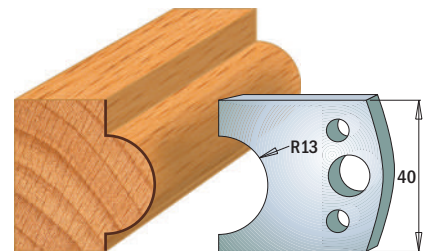

Pair of knives **690.119**
Pair of limiters **691.119**

NOTE: all knives & limiters available only in pairs.
Drawings are 1:2 scale. Dimensions in mm.

Profile Knives and Limiters

Cutting Length=40mm Thickness=4mm

Pack Qty. 10



SP

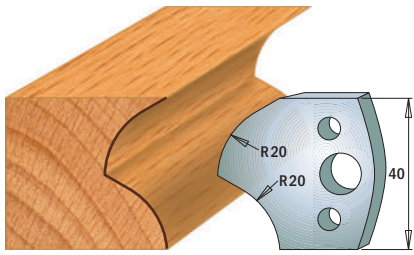

Pair of knives **690.120**
Pair of limiters **691.120**

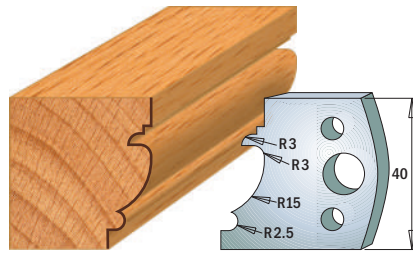

Pair of knives **690.121**
Pair of limiters **691.121**

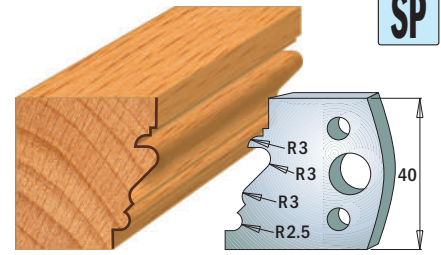

Pair of knives **690.122**
Pair of limiters **691.122**

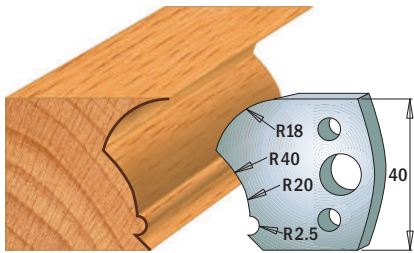

Pair of knives **690.123**
Pair of limiters **691.123**

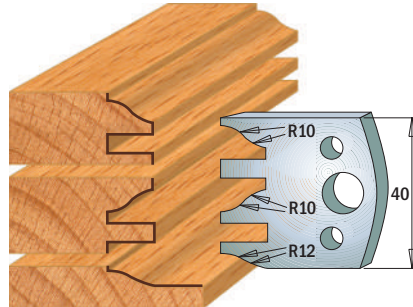

Pair of knives **690.124**
Pair of limiters **691.124**

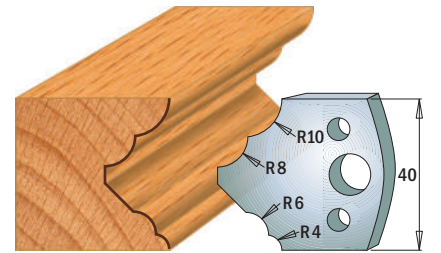

Pair of knives **690.125**
Pair of limiters **691.125**

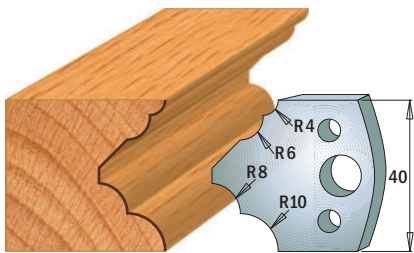

Pair of knives **690.126**
Pair of limiters **691.126**

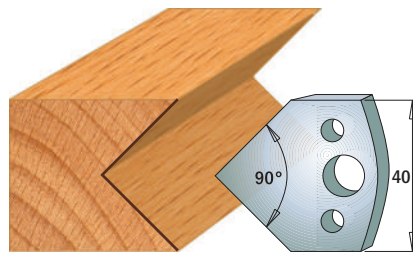

Pair of knives **690.127**
Pair of limiters **691.127**

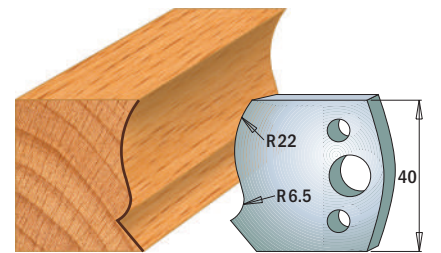

Pair of knives **690.128**
Pair of limiters **691.128**

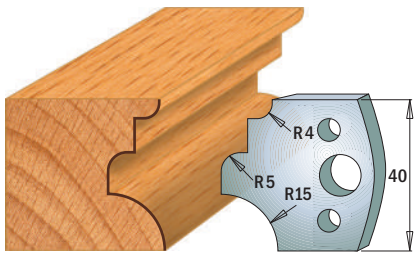

Pair of knives **690.129**
Pair of limiters **691.129**

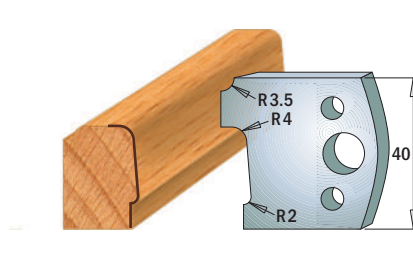

Pair of knives **690.130**
Pair of limiters **691.130**

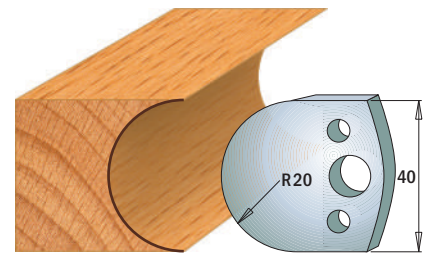

Pair of knives **690.131**
Pair of limiters **691.131**

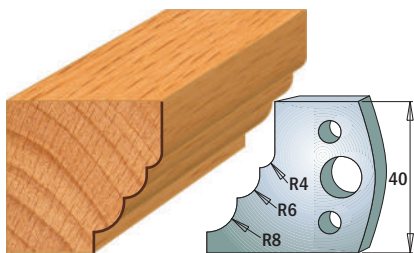

Pair of knives **690.132**
Pair of limiters **691.132**

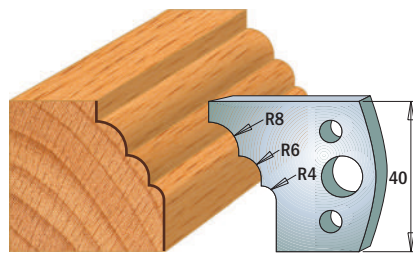

Pair of knives **690.133**
Pair of limiters **691.133**

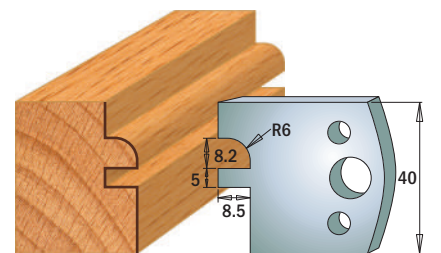

Pair of knives **690.134**
Pair of limiters **691.134**

NOTE: all knives & limiters available only in pairs.
Drawings are 1:2 scale. Dimensions in mm.

Profile Knives and Limiters

Cutting Length=40mm Thickness=4mm

Pack Qty. 10



SP

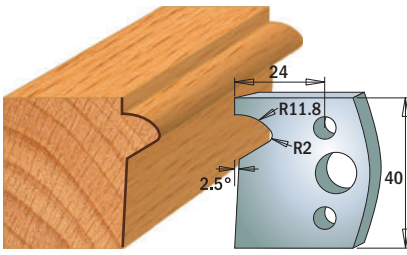

Pair of knives **690.135**
Pair of limiters **691.135**

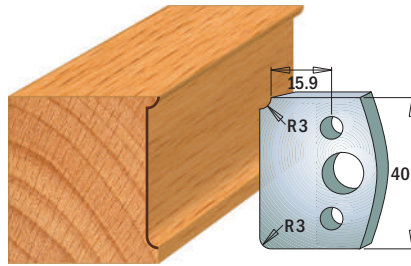

Pair of knives **690.170**
Pair of limiters **691.170**

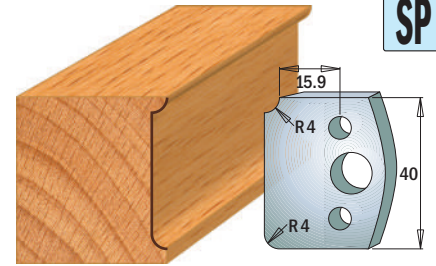

Pair of knives **690.171**
Pair of limiters **691.171**

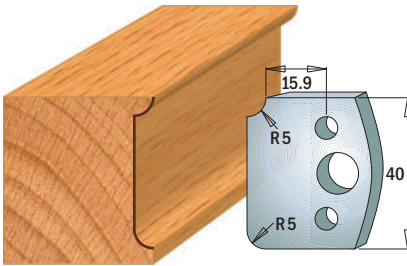

Pair of knives **690.172**
Pair of limiters **691.172**

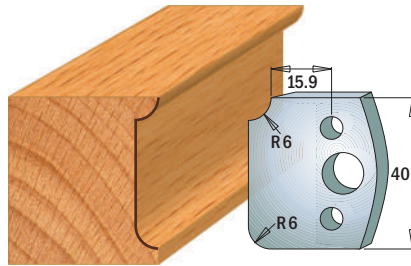

Pair of knives **690.173**
Pair of limiters **691.173**

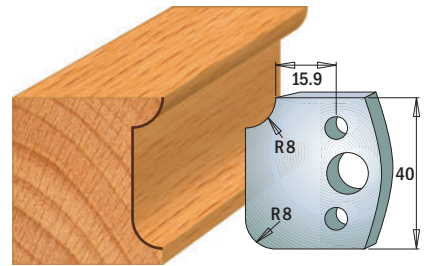

Pair of knives **690.174**
Pair of limiters **691.174**

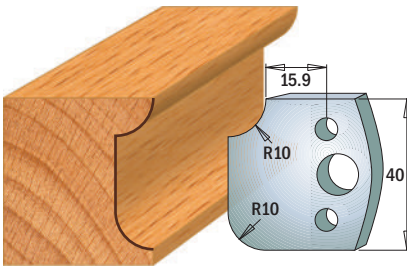

Pair of knives **690.175**
Pair of limiters **691.175**

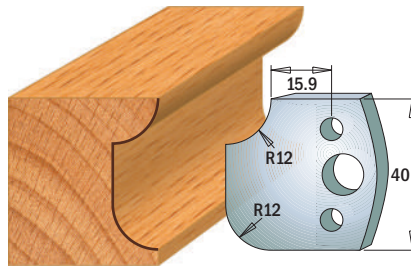

Pair of knives **690.176**
Pair of limiters **691.176**

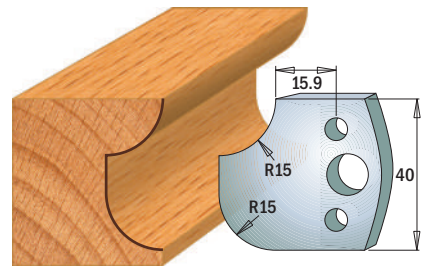

Pair of knives **690.177**
Pair of limiters **691.177**

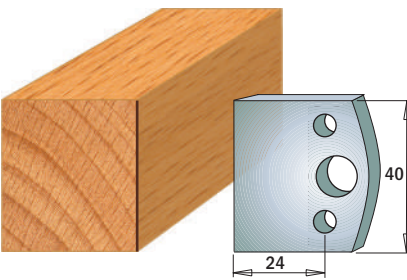

Pair of knives **690.192**
Pair of limiters **691.192**

Profile Knives and Limiters
Cutting Length=50mm
Thickness=4mm
Pack Qty. 10

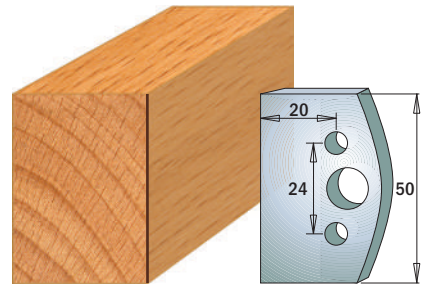

Pair of knives **690.500**
Pair of limiters **691.500**

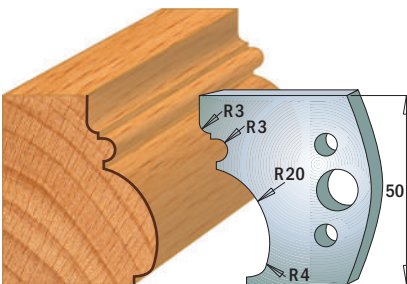

Pair of knives **690.501**
Pair of limiters **691.501**

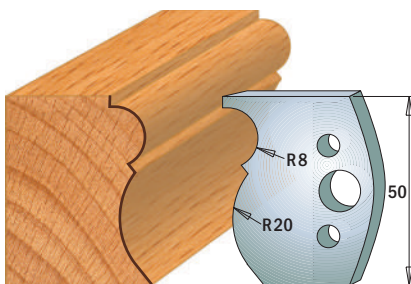

Pair of knives **690.502**
Pair of limiters **691.502**

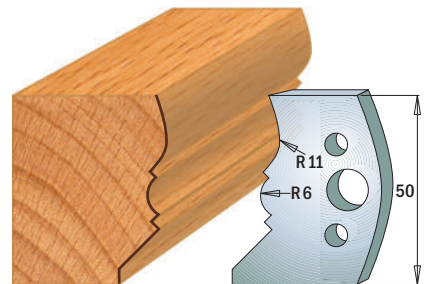

Pair of knives **690.503**
Pair of limiters **691.503**

NOTE: all knives & limiters available only in pairs.
Drawings are 1:2 scale. Dimensions in mm.

Profile Knives and Limiters

Cutting Length=50mm Thickness=4mm

Pack Qty. 10



SP

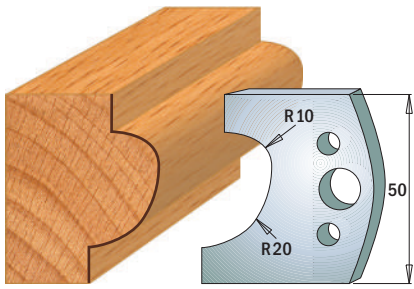

Pair of knives **690.504**
Pair of limiters **691.504**

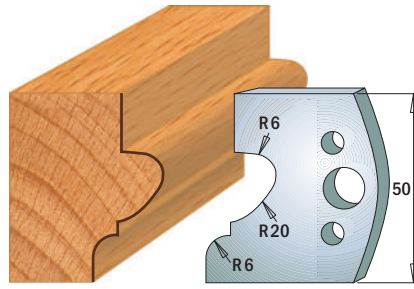

Pair of knives **690.505**
Pair of limiters **691.505**

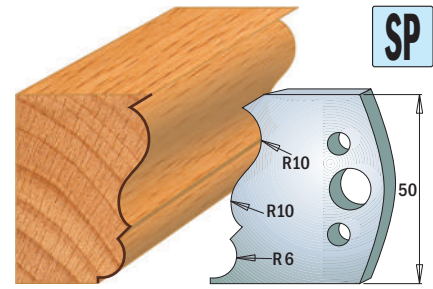

Pair of knives **690.506**
Pair of limiters **691.506**

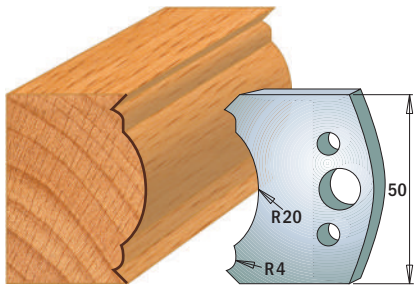

Pair of knives **690.507**
Pair of limiters **691.507**

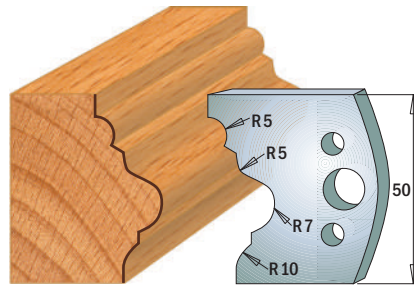

Pair of knives **690.508**
Pair of limiters **691.508**

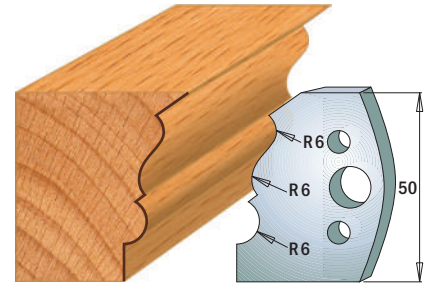

Pair of knives **690.509**
Pair of limiters **691.509**

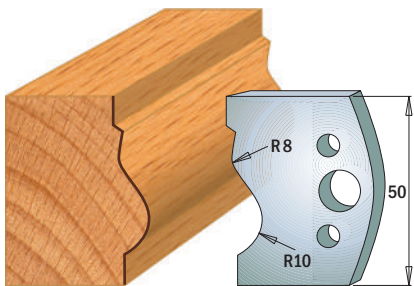

Pair of knives **690.510**
Pair of limiters **691.510**

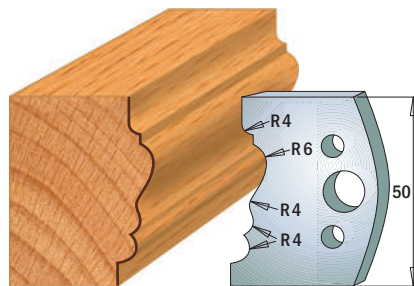

Pair of knives **690.511**
Pair of limiters **691.511**

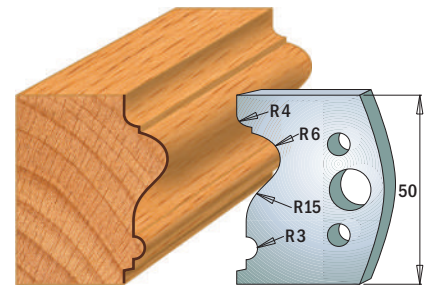

Pair of knives **690.512**
Pair of limiters **691.512**

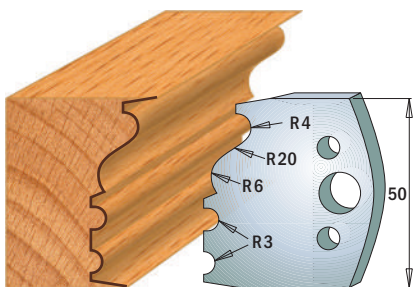

Pair of knives **690.513**
Pair of limiters **691.513**

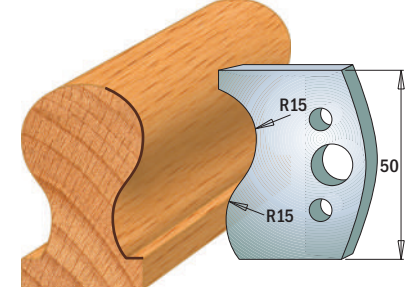

Pair of knives **690.514**
Pair of limiters **691.514**

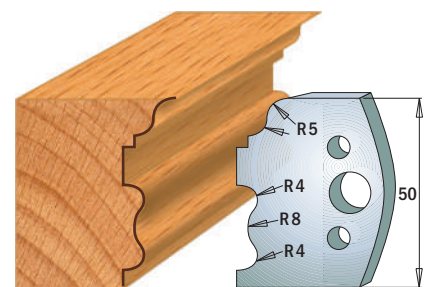

Pair of knives **690.515**
Pair of limiters **691.515**

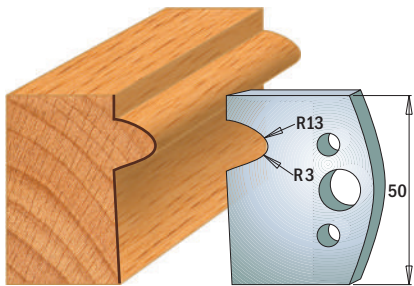

Pair of knives **690.516**
Pair of limiters **691.516**

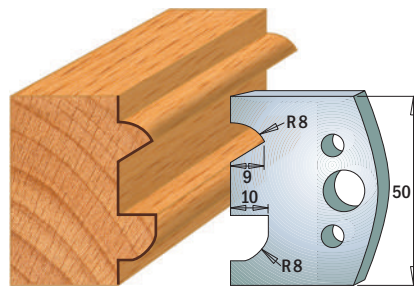

Pair of knives **690.517**
Pair of limiters **691.517**

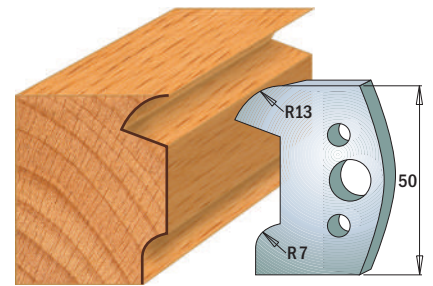

Pair of knives **690.518**
Pair of limiters **691.518**

NOTE: all knives & limiters available only in pairs.
Drawings are 1:2 scale. Dimensions in mm.

Profile Knives and Limiters

Cutting Length=50mm Thickness=4mm

Pack Qty. 10



SP

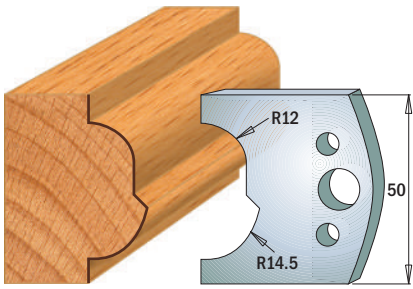

Pair of knives **690.519**
Pair of limiters **691.519**

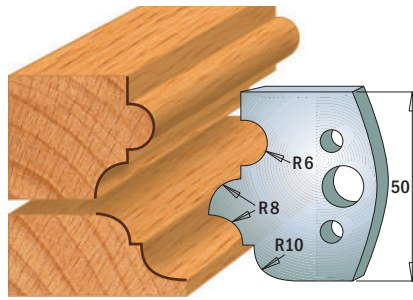

Pair of knives **690.520**
Pair of limiters **691.520**

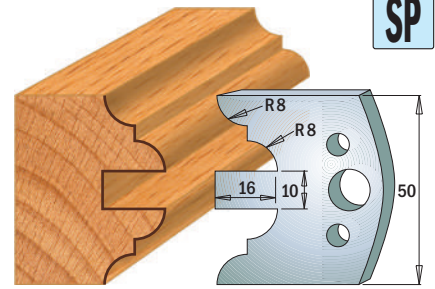

Pair of knives **690.522**
Pair of limiters **691.522**

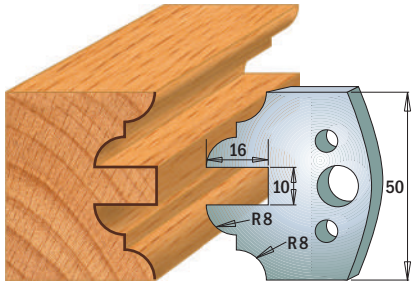

Pair of knives **690.523**
Pair of limiters **691.523**

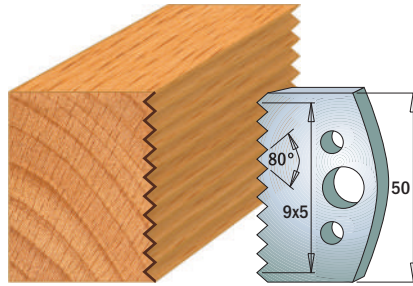

Pair of knives **690.524**
Pair of limiters **691.524**

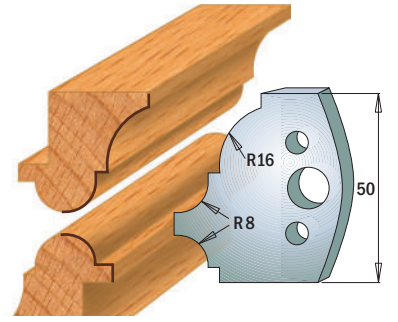

Pair of knives **690.541**
Pair of limiters **691.541**

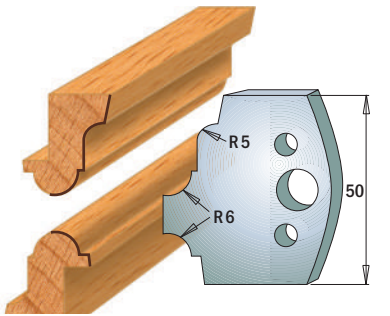

Pair of knives **690.542**
Pair of limiters **691.542**

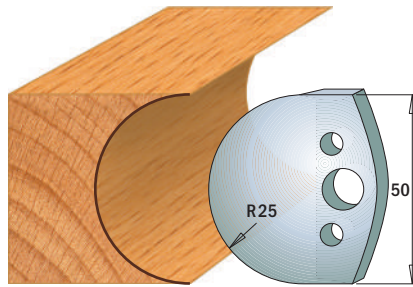

Pair of knives **690.543**
Pair of limiters **691.543**

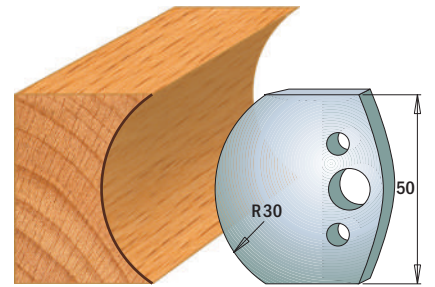

Pair of knives **690.544**
Pair of limiters **691.544**

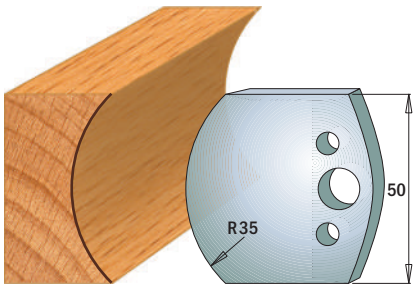

Pair of knives **690.545**
Pair of limiters **691.545**

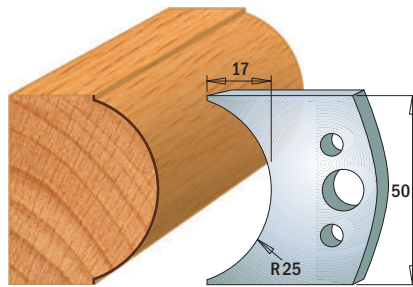

Pair of knives **690.546**
Pair of limiters **691.546**

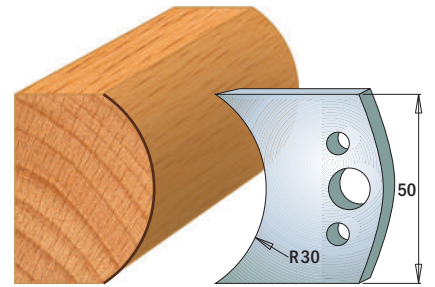

Pair of knives **690.547**
Pair of limiters **691.547**

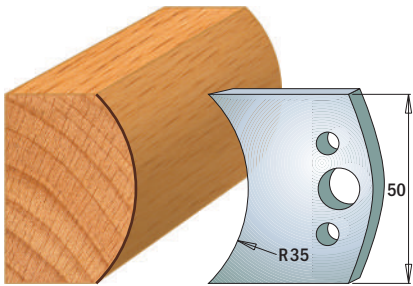

Pair of knives **690.548**
Pair of limiters **691.548**

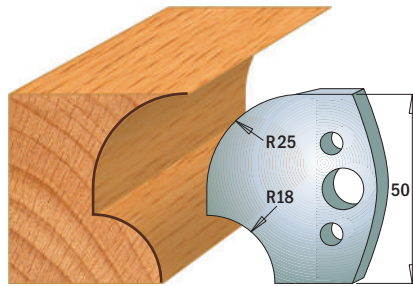

Pair of knives **690.549**
Pair of limiters **691.549**

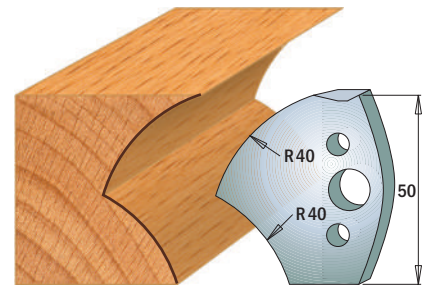

Pair of knives **690.550**
Pair of limiters **691.550**

NOTE: all knives & limiters available only in pairs.
Drawings are 1:2 scale. Dimensions in mm.

Profile Knives and Limiters

Cutting Length=50mm Thickness=4mm

Pack Qty. 10



SP

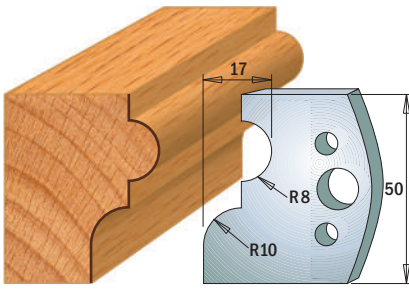

Pair of knives **690.551**
Pair of limiters **691.551**

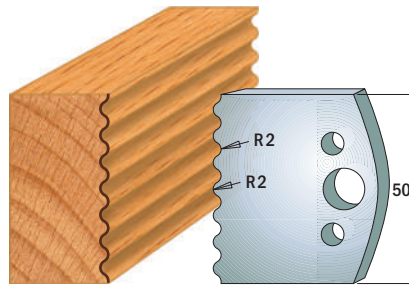

Pair of knives **690.552**
Pair of limiters **691.552**

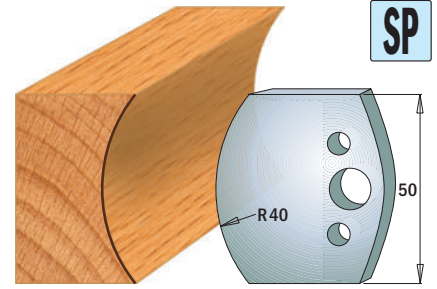

Pair of knives **690.553**
Pair of limiters **691.553**

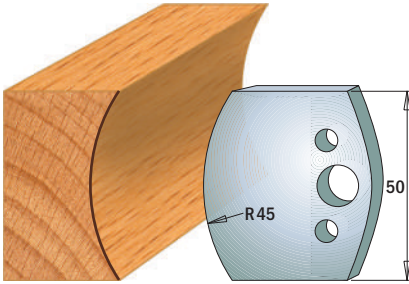

Pair of knives **690.554**
Pair of limiters **691.554**

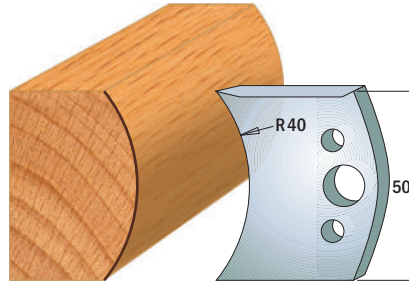

Pair of knives **690.555**
Pair of limiters **691.555**

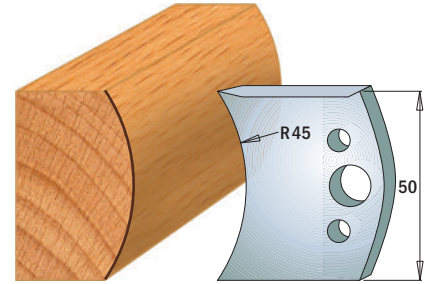

Pair of knives **690.556**
Pair of limiters **691.556**

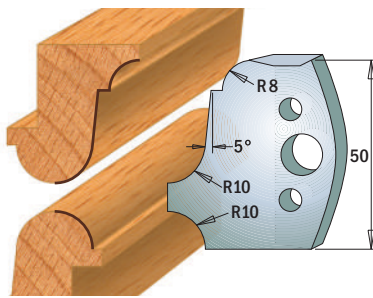

Pair of knives **690.557**
Pair of limiters **691.557**

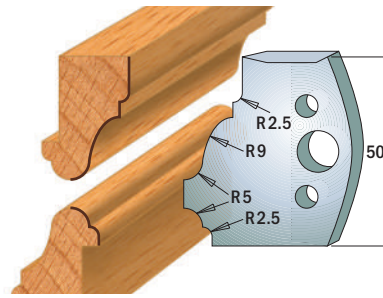

Pair of knives **690.558**
Pair of limiters **691.558**

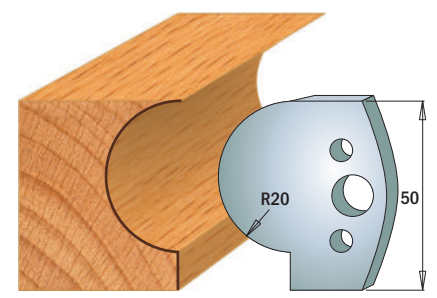

Pair of knives **690.562**
Pair of limiters **691.562**

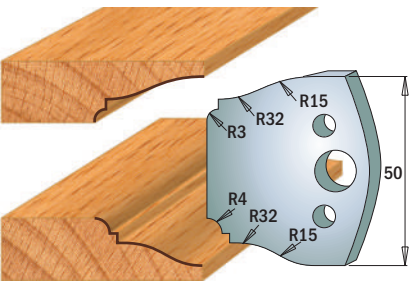

Pair of knives **690.568**
Pair of limiters **691.568**

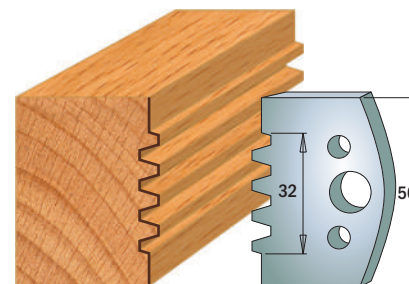

Pair of knives **690.576**
Pair of limiters **691.576**

NOTE: all knives & limiters available only in pairs.
Drawings are 1:2 scale. Dimensions in mm.

690-691

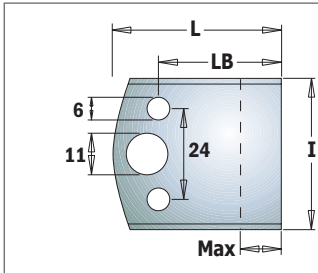

DESCRIPTION	I mm	LB mm	L mm	MAX mm		ORDER NO. SP	ORDER NO. HSS
Pair of knives	40	32,5	44,5	18	10	690.193	690.193H
Pair of knives	50	34	46	20	10	690.599	690.599H
Pair of limiters	38	16	28	2	10	691.190	
Pair of limiters	38	24	36	10	10	691.192	
Pair of limiters	38	32,5	44,5	18	10	691.193	
Pair of limiters	48	34	46	20	10	691.599	

Pair of Bore Reducers

699

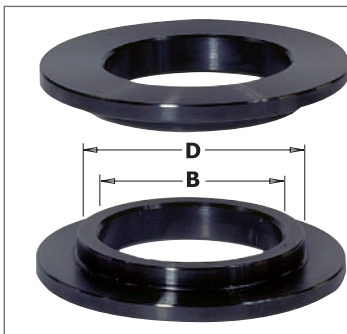

D mm	B mm		ORDER NO.	D mm	B mm		ORDER NO.
19,05	12,7	10	699.019.13	35	32	10	699.035.32
25,4	19,05	10	699.026.19	40	30	10	699.040.30
30	19,05	10	699.030.19	40	32	10	699.040.32
30	25,4	10	699.030.26	40	35	10	699.040.35
31,75	19,05	10	699.031.19	50	30	1	699.050.30
31,75	25,4	10	699.031.26	50	32	1	699.050.32
31,75	30	10	699.031.30	50	35	1	699.050.35
35	30	10	699.035.30	50	40	1	699.050.40
35	31,75	10	699.035.31				

To be used only in pairs

Chucks & "ER20" Collets for Spindle Moulder Machine

796

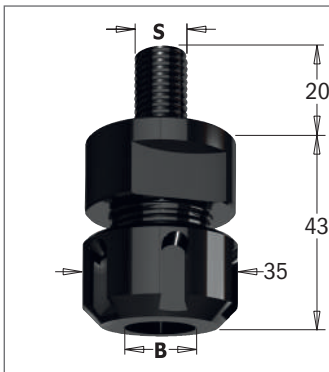

S mm	B mm	L mm		ORDER NO.
M12x1,75	3 ~ 12,7	43	10	796.122.00
M14x2	3 ~ 12,7	43	10	796.142.00
M16x2	3 ~ 12,7	43	10	796.162.00

Spare parts: 992.483.03 M25x1,5mm clamping nut
991.483.00 "ER20" key

TECHNICAL DETAILS:
Super strength steel.
Precisely machined for accuracy.

Collet not included

SAFETY TIPS

The **TW-200** Torque Wrench is recommended for the proper fastening of clamping nuts. (see page 413)

"ER20" Precision Collets for Chucks 796.122/142/162

184





B mm		ORDER NO.	B mm		ORDER NO.
2	10	184.020.20	10	10	184.100.20
3	10	184.030.20	11	10	184.110.20
4	10	184.040.20	12	10	184.120.20
5	10	184.050.20	12,7	10	184.127.20
6	10	184.060.20			
6,35	10	184.064.20			
7	10	184.070.20			
8	10	184.080.20			
9	10	184.090.20			



790

	L mm	H mm	K mm	MACHINE	MODEL MACHINE	ORDER NO.	ORDER NO.	
						2 pcs. blister case	10 pcs. blister case	
    10 PCS. CASE (MINIMUM ORDER)  2 PCS. BLISTER CASE (790.755/790.780/790.806/790.805/790.820)	56 x 5,5 x 1,1	ADLER®					790.560.00	
	60 x 5,5 x 1,1	WEGOMA®					790.600.01	
	75,5 x 5,5 x 1,1	AEG®	HTH75					790.755.00
		BLACK & DECKER®	DN75, 750SR, 600K					
		BOSCH®	0590, P400, 1590,1591					
		FESTOOL®	REP75					
		HAFFNER®	FH222					
		HOLZ-HER®	2223, 2286, 2320					
		KRESS®	JET-STAR 6701, 6702					
		MAFELL®	HU75					
		METABO®	6375					
		SCHEER®	MH75/3, MH80					
	SKIL®	98H						
	78 x 5,5 x 1,1	VIRUTEX®					790.780	790.780.00
	80,5 x 5,5 x 1,1	AEG®, BOSCH®					790.805	790.805.01
		HAFFNER®						
	82 x 5,5 x 1,1	ELU®	MFF40, MFF80, MFF81, MFF81EK, PF161					
		AEG®	EH82, EH825, EH822, EH450, EH700, EH82-1, H500, H750, EH700R				790.820	790.820.00
		BLACK & DECKER®	DN76					
		BOSCH®	PHO 100/150, PHO 200/300 4387, PHO 2-82/3-82, GUSTAV, H00882					
CASALS®		CE82						
DEWALT®		DW678, DW678EK, DW680						
ELU®		HH15, HH40, HH40K, HH40EK						
FEIN®		HS2151						
FELISATTI®		TP282						
HAFFNER®		FH224						
HITACHI®		F20, F20A, FP20A, P20V, P20SA						
HOLZ-HER®		2321, 2322						
LEGNA®		R82, G82						
MAFELL®		EHU82, MHU82						
MAKITA®		1001, 1100, 1125B, 1900B, 1901, 1923B, 1923H, 1923HO						
METABO®		4382, 8382, 0882, 0883, E0983						
PERLES®		HHB82B						
PEUGEOT®		RA400, 82RAC, RA82CS, BR82 BRA1-82, BRA3-82, RA1082CA						
RYOBI®		L1323-A						
SKIL®		H92, H94, H95, H96, H97 1506, 1510						
STAYER®		980B						
92 x 5,5 x 1,2		AEG®	450					790.920.00
	HITACHI®	F30A, FU30						
	RYOBI®	L120N, L150N, L1205N, L1323						
102 x 5,5 x 1,1	AEG®	HB750, EH102, HBE800					790.992.00	

	L mm	H mm	K mm	MACHINE	MODEL MACHINE	ORDER NO.	ORDER NO.
						2 pcs. HSS	2 pcs. HW
  2 PCS. BLISTER CASE	82	x 29	x 3	BOSCH®	GH020-82	790.821.50	790.821.10
				BLACK & DECKER®	DN710, DB711		
				MAKITA®	1900B, 1923B, 1100, 1901 1125, KP0800K, KP0810, XPK01		
				RYOBI®	L-1323A, L-282		
110 x 29 x 3	MAKITA®	1002BA, 1911B			790.110.50		
TECHNICAL DETAILS: - Order no. ISO: K40 - Hardness (HV10): 1.400 - Transverse rupture strength (N/mm ²): 2.600						APPLICATION: Softwood Good Hardwood Suitable Plywood Suitable	

793

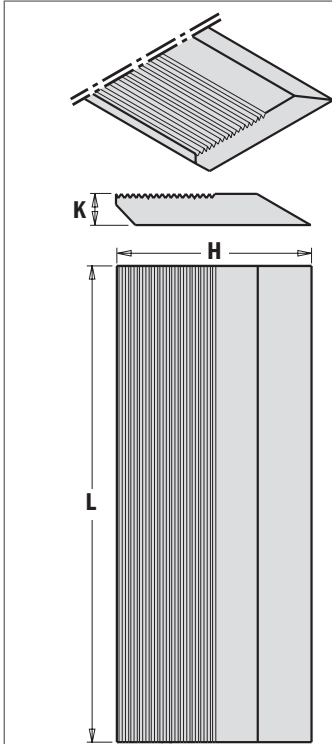

IN QUADROPACK PACKAGING
4 KNIVES FOR EACH SET

MATERIAL	HSS
Dry softwood	●
Wet softwood	●
Dry hardwood	●
Wet hardwood	○

- Suitable
- Party suitable

L mm	H mm	K mm	ORDER NO. pieces for each set		ORDER NO. HSS
40 x	50 x	8	4	1	793.040.50 ■
40 x	60 x	8	4	1	793.040.60 ■
40 x	70 x	8	4	1	793.040.70 ■
60 x	50 x	8	4	1	793.060.50 ■
60 x	60 x	8	4	1	793.060.60 ■
60 x	70 x	8	4	1	793.060.70 ■
80 x	50 x	8	4	1	793.080.50 ■
80 x	60 x	8	4	1	793.080.60 ■
80 x	70 x	8	4	1	793.080.70 ■
100 x	50 x	8	4	1	793.100.50 ■
100 x	60 x	8	4	1	793.100.60 ■
100 x	70 x	8	4	1	793.100.70 ■
120 x	50 x	8	4	1	793.120.50 ■
120 x	60 x	8	4	1	793.120.60 ■
120 x	70 x	8	4	1	793.120.70 ■
130 x	60 x	8	4	1	793.130.60 ■
130 x	70 x	8	4	1	793.130.70 ■
650 x	50 x	8	4	1	793.650.50 ■
650 x	60 x	8	4	1	793.650.60 ■
650 x	70 x	8	4	1	793.650.70 ■

■ Until stock last

REMARK: special dimensions available on request.

TECHNICAL DETAILS:

Corrugated back moulder knives for profile cutter heads with precise positioning, angle 60°, pitch 1,6mm.

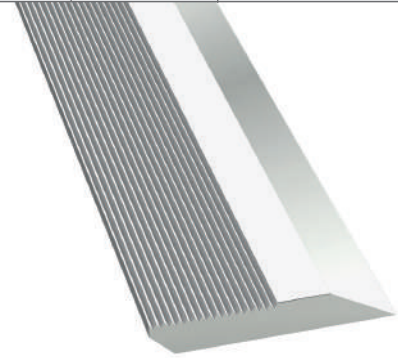

Set of 2 Magnetic Knife Setting Jigs



Insert your knives into the tool holders and align them perfectly with this set! Perfect micro adjustments on will guarantee excellent cutting performance!

1. MAGNETIC STOP
2. JOINTS WITH MAGNETIC CONNECTORS
3. LOCK SCREW

CMT792

2 SETUP POSSIBILITIES

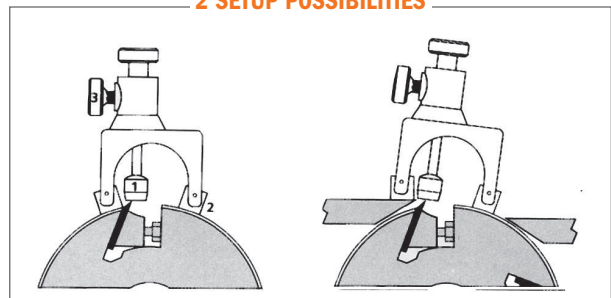

Positioning on the tool holder body with detection of the knife position.

Direct positioning on both the planer table and the tool holder body with detection of the knife position.

DESCRIPTION		ORDER NO.
Set of 2 magnetic knife setting jigs	25	CMT792

792

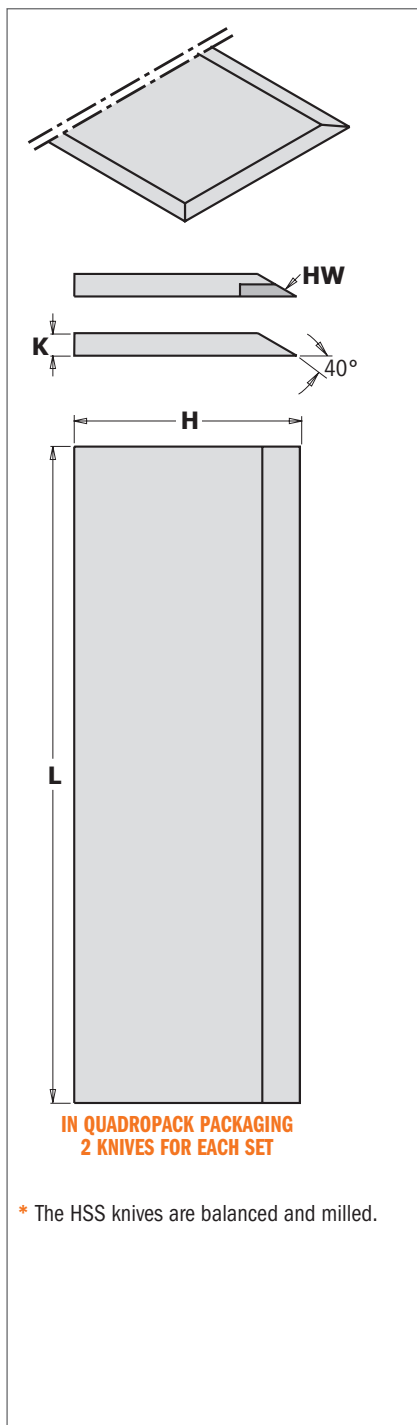

L mm	H mm	K mm	KNIVES pieces for each set		ORDER NO. SP	ORDER NO. HSS*	ORDER NO. HW
130 x	30 x	3	2	1		792.130.30	792.132.30
150 x	30 x	3	2	1		792.150.30	
180 x	30 x	3	2	1		792.180.30	792.182.30
200 x	30 x	3	2	1		792.200.30	
210 x	30 x	3	2	1		792.210.30	
230 x	30 x	3	2	1		792.230.30	792.232.30
250 x	30 x	3	2	1	792.251.30	792.250.30	792.252.30
260 x	30 x	3	2	1	792.261.30	792.260.30	792.262.30
300 x	30 x	3	2	1	792.301.30	792.300.30	792.302.30
310 x	30 x	3	2	1		792.310.30	792.312.30
350 x	30 x	3	2	1		792.350.30	792.352.30
400 x	30 x	3	2	1	792.401.30	792.400.30	792.402.30
410 x	30 x	3	2	1		792.410.30	792.412.30
430 x	30 x	3	2	1		792.430.30	
450 x	30 x	3	2	1	792.451.30	792.450.30	
500 x	30 x	3	2	1	792.501.30	792.500.30	792.502.30
510 x	30 x	3	2	1		792.510.30	792.512.30
520 x	30 x	3	2	1		792.520.30	792.522.30
530 x	30 x	3	2	1		792.530.30	792.532.30
600 x	30 x	3	2	1		792.600.30	
610 x	30 x	3	2	1		792.610.30	
630 x	30 x	3	2	1		792.630.30	792.632.30
640 x	30 x	3	2	1		792.640.30	
810 x	30 x	3	2	1		792.810.30	
1050 x	30 x	3	2	1	792.998.30	792.997.30	792.999.30
300 x	35 x	3	2	1		792.300.35	
350 x	35 x	3	2	1		792.350.35	
400 x	35 x	3	2	1	792.401.35	792.400.35	
410 x	35 x	3	2	1		792.410.35	
430 x	35 x	3	2	1		792.430.35	
450 x	35 x	3	2	1	792.451.35	792.450.35	
500 x	35 x	3	2	1	792.501.35	792.500.35	
510 x	35 x	3	2	1	792.511.35	792.510.35	
520 x	35 x	3	2	1	792.521.35	792.520.35	
530 x	35 x	3	2	1		792.530.35	
550 x	35 x	3	2	1	792.551.35	792.550.35	
600 x	35 x	3	2	1	792.601.35	792.600.35	
610 x	35 x	3	2	1	792.611.35	792.610.35	
630 x	35 x	3	2	1	792.631.35	792.630.35	
650 x	35 x	3	2	1		792.650.35	
710 x	35 x	3	2	1		792.710.35	
810 x	35 x	3	2	1		792.810.35	
820 x	35 x	3	2	1			
1050 x	35 x	3	2	1	792.998.35	792.997.35	

MATERIAL	SP	HSS	HW
Dry softwood	○	●	
Wet softwood	○	○	
Dry hardwood	○	●	●
Wet hardwood	○	●	○
Chipboard			○
MDF			○
Glulam		○	●
Solid surface			○

- Suitable
- Partly suitable

REMARK: special dimensions available on request.
The mirror finish on HW knives produces both razor sharp and extremely durable cutting edges.



795

TERSA®

CENTROSTAR, CENTROFIX, QUICKFIX

CENTROLOCK

TERSA®

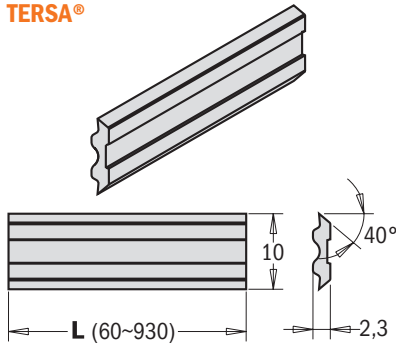

**CENTROSTAR
CENTROFIX
QUICKFIX**

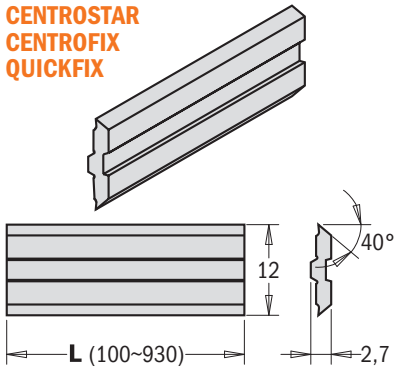

CENTROLOCK

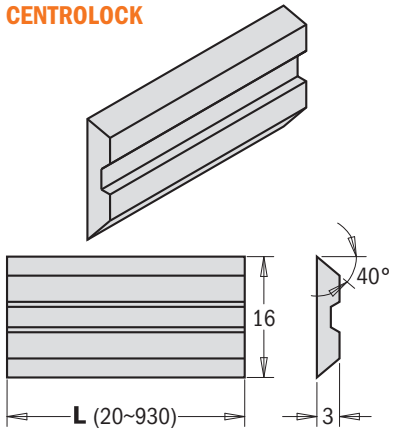

2 KNIVES FOR EACH SET

L mm	H mm	K mm	ORDER NO.	L mm	H mm	K mm	ORDER NO.	L mm	H mm	K mm	ORDER NO.
100	10	2,3	795.100.10								
110	10	2,3	795.110.10								
120	10	2,3	795.120.10								
130	10	2,3	795.130.10	130	12	2,7	795.130.12	130	16	3	795.130.16
180	10	2,3	795.180.10	180	12	2,7	795.180.12	170	16	3	795.170.16
210	10	2,3	795.210.10					180	16	3	795.180.16
230	10	2,3	795.230.10					190	16	3	795.190.16
260	10	2,3	795.260.10					230	16	3	795.230.16
300	10	2,3	795.300.10	240	12	2,7	795.240.12	240	16	3	795.240.16
310	10	2,3	795.310.10	310	12	2,7	795.310.12	260	16	3	795.260.16
350	10	2,3	795.350.10					270	16	3	795.270.16
400	10	2,3	795.400.10					310	16	3	795.310.16
410	10	2,3	795.410.10	410	12	2,7	795.410.12				
420	10	2,3	795.420.10								
430	10	2,3	795.430.10								
450	10	2,3	795.450.10								
500	10	2,3	795.500.10								
510	10	2,3	795.510.10	510	12	2,7	795.510.12				
520	10	2,3	795.520.10	520	12	2,7	795.520.12				
530	10	2,3	795.530.10								
540	10	2,3	795.540.10								
630	10	2,3	795.630.10	630	12	2,7	795.630.12				
640	10	2,3	795.640.10	640	12	2,7	795.640.12				
930	10	2,3	795.930.10								

TECHNICAL DETAILS:

HPS® is a material specially formulated using special heat treatments developed for the woodworking industry by Thyssen-Krupp. This steel is enhanced with the following special attributes:

- superb wear resistance
- maximum level of toughness
- resistance to softening
- easy to profile - tested for long life

Test results on Oak: - Spindle speed=6000 rpm,
- Feed speed=24 meter/min
= Result HPS® 17500 meters.
= Result HSS 10000 meters.

MATERIAL	GOOD	EXCELLENT
Dry Softwood		●
Wet Softwood		●
Dry Hardwood		●
Wet Hardwood		●
Exotic Hardwood	●	

790



	L mm	H mm	K mm	TYPE	A	Z	ORDER NO. K1920	ORDER NO. K2250
	7,5	12	1,5		35°	2	790.075.00	
	7,65	12	1,5		35°	2	790.076.00	
	9,6	12	1,5		35°	2	790.096.00	
	15	12	1,5		35°	2	790.150.00	
	19,5	12	1,5		35°	4	790.195.12	
20	12	1,5		35°	2	790.200.00	790.200.03	

	L mm	H mm	K mm		A	Z	ORDER NO. K1920	ORDER NO. K2250
	24,7	12	1,5		35°	2	790.250.00	
	30	12	1,5		35°	2	790.300.00	790.300.03
	30	12	1,5		45°	2	790.300.20	
	40	12	1,5		35°	2	790.400.00	790.400.03
	50	12	1,5		35°	2	790.500.00	790.500.03
60	12	1,5		35°	2	790.600.00	790.600.03	

	L mm	H mm	K mm	TYPE	A	Z	ORDER NO. K1920	
	29,5	9	1,5		35°	4	790.295.09	
	29,5	12	1,5		35°	4	790.295.12	
	39,5	9	1,5		35°	4	790.395.09	
	39,5	12	1,5		35°	4	790.395.12	
	49,2	9	1,5		35°	4	790.495.09	
	49,2	12	1,5		35°	4	790.495.12	
	58	12	1,5		35°	2	790.580.01	

	L mm	H mm	K mm		A	Z	ORDER NO. K1920	
	28,3	12	1,5		35°	4	790.283.12	
	48,3	12	1,5		35°	4	790.483.12	

	L mm	H mm	K mm		A	Z	ORDER NO. K1920	ORDER NO. K2250
	10,5	10,5	1,5		35°	4		790.105.03
	12	12	1,5		35°	4	790.120.00	790.120.03

	L mm	H mm	K mm		A	Z	ORDER NO. K1920	ORDER NO. K2250
	13,6	13,6	2		30°	4	790.136.00	
	14	14	1,2		30°	4	790.140.10	
	14	14	2		30°	4	790.140.00	790.140.03
	14	14	2		45°	4	790.140.02	

	L mm	H mm	K mm		A	Z	ORDER NO. K1920	
	12	12	1,5		30°	4	790.120.20	
	14	14	2		30°		790.140.20	

	L mm	H mm	K mm	R mm	A	Z	ORDER NO. K1920	
	15	15	2,5	115	30°	4	790.152.12	
	15	15	2,5	150	30°	4	790.152.22	

	L mm	H mm	K mm		A	Z	ORDER NO. K1920	
	20	4,1	1,1		35°	4	790.200.01	
	30	5,5	1,1		35°	4	790.300.01	
	50	5,5	1,1		35°	4	790.500.01	

790



	L mm	H mm	K mm	A	Z	ORDER NO.
	50	9	1,5	35°	4	790.500.09
	50	12	1,7	35°	4	790.503.00

	L mm	H mm	K mm	B	A	Z	ORDER NO.
	20	12	1,5	1	35°	2	790.201.00
	24	12	1,5	1	35°	2	790.242.00
	30	12	1,5	2	35°	2	790.301.00
	50	12	1,5	2	35°	2	790.501.00

	L mm	H mm	K mm	Z	ORDER NO.
	18	18	1,95	4	790.181.00
	18	18	2,45	4	790.182.00

	L mm	H mm	K mm	A	Z	ORDER NO.
	22	19	2	30°	3	790.220.02

	L mm	H mm	K mm	A	Z	ORDER NO.
	28	14	2	30°	2	790.280.00

	L mm	H mm	K mm	R mm	A	Z	ORDER NO.
	16	22	5	1,5			790.161.00
	16	22	5	2			790.162.00
	16	22	5	3			790.163.00
	16	22	5		45°		790.160.00

	L mm	H mm	K mm	R mm	A	Z	ORDER NO.
	19,5	9	1,5	2	35°	2	790.020.00
	19,5	9	1,5	3	35°	2	790.030.00
	19,5	9	1,5	5	35°	2	790.050.00
	24	12	1,5	6,4	35°	2	790.064.00
	24	12	1,5	8	35°	2	790.080.00

	L mm	H mm	K mm	A	Z	ORDER NO.
	30	12	1,5	35°	1	790.300.60*

*These knives are supplied in a 2 pc. case. Minimum 2 pieces or multiple of 2 piece order.

MATERIAL	K1920	K2250
Softwood	★★★★	
Hardwood	★★★★★	
Chipboard	★★★★★	★★★★★
MDF	★★★★★	★★★★★
HDF	★★★★★	★★★★★
Plastics	★★★	★★★★★
Solid Surface		★★★★★

TECHNICAL DETAILS:





















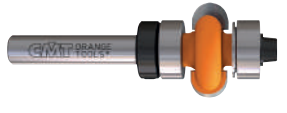



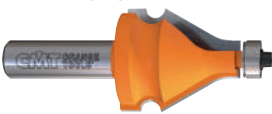



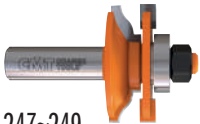
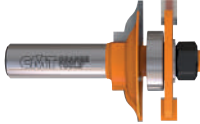















K1920 Hardness (HV10): 1.920 - Transverse rupture strength (N/mm²): 2.600
New chrome grade for universal cutting applications. Excellent resistance to corrosion, oxidation and mechanical wear. High efficiency, 20% longer lifetime compared to standard grade.

K2250 Hardness (HV10): 2.250 - Transverse rupture strength (N/mm²): 2.400
New nano-grain grade for maximum wear resistance. Higher efficiency due to improved tool lifetime. Improved toughness.

All knives are supplied in a 10 pc. case.
Minimum 10 piece or multiple of 10 piece order.



<p>UP & DOWN CUT SPIRAL</p>  <p>180</p>	<p>Z1 UPCUT SPIRAL</p>  <p>180</p>	<p>Z2 UP & DOWN CUT SPIRAL</p>  <p>181</p>	<p>STRAIGHT WITH CENTER TIP</p>  <p>182</p>
<p>STRAIGHT</p>  <p>183-185</p>	<p>STRAIGHT WITH THREADED SHANK</p>  <p>186</p>	<p>SPIRAL FOR ALUMINIUM</p>  <p>187</p>	<p>STRAIGHT WITH INSERT KNIVES</p>  <p>188-189</p>
<p>MORTISING & HINGE</p>  <p>190-191</p>	<p>PATTERN</p>  <p>192</p>	<p>PATTERN WITH INSERT KNIVES</p>  <p>193</p>	<p>WEATHERSEAL</p>  <p>194</p>
<p>COMBINATION TRIMMER</p>  <p>194-195</p>	<p>COMBINATION TRIMMER WITH BEARING</p>  <p>195</p>	<p>FLUSH TRIM</p>  <p>196-197</p>	<p>SPIRAL FLUSH TRIM</p>  <p>198</p>
<p>FLUSH TRIM FOR LAMINATE</p>  <p>198-199</p>	<p>FLUSH TRIM WITH INSERT KNIVES</p>  <p>199</p>	<p>PATTERN/FLUSH WITH INSERT KNIVES</p>  <p>200</p>	<p>PATTERN/FLUSH TRIM</p>  <p>200</p>
<p>PANEL PILOT</p>  <p>201</p>	<p>RABBETING</p>  <p>202-204</p>	<p>RABBETING WITH INSERT KNIVES</p>  <p>203-204</p>	<p>KEYHOLE</p>  <p>205</p>
<p>T-SLOT</p>  <p>205</p>	<p>SCREW SLOT</p>  <p>206</p>	<p>SLOT FOR FLOORING</p>  <p>206</p>	<p>SLOT CUTTERS & SETS</p>  <p>207-209</p>
<p>LOCK MITER</p>  <p>210-211</p>	<p>GLUE JOINT</p>  <p>212</p>	<p>DRAWER LOCK</p>  <p>213</p>	
<p>WINDOW SASH</p>  <p>214</p>		<p>GLASS DOOR SASH</p>  <p>215</p>	
<p>V-TONGUE & GROOVE</p>  <p>217</p>		<p>EDGE BANDING</p>  <p>217</p>	
<p>FINGER JOINT</p>  <p>216</p>	<p>DOVETAIL</p>  <p>218-219</p>	<p>60° LETTERING</p>  <p>221</p>	<p>BOWL & TRAY</p>  <p>221</p>
<p>V-GROOVING & LASER POINT</p>  <p>222-224</p>	<p>CHAMFER</p>  <p>225-226</p>	<p>CHAMFER WITH INSERT KNIVES</p>  <p>225</p>	<p>ROUND NOSE</p>  <p>227</p>

BALL END  228	COVE  229-230	OVOLO & ROUNDOVER  230-233	ROUNDOVER WITH INSERT KNIVES  231
DECORATIVE BEADING  234-235	OGEE & PROFILES  236-237	ADJUSTABLE ROUNDOVER  238	WAINSCOT PANELING  239
CORNER BEADING  239-240	BEAD & BULL NOSE  240	EDGE-FLUTING  241	
MOULDING SYSTEM  241		MOULDING  242-244	FINGER PULL DOOR LIP  244-245
TABLE EDGE & HAND RAIL  246		VERTICAL RAISED PANEL  246	RAISED PANEL  250-251
RAIL & STILE SET  247-249		STILE & PANEL  252	STRIPLOX® CUTTER  253
SOLID SURFACE COUNTER-TOP TRIM  253	SOLID SURFACE ROUNDOVER  254-255	SOLID SURFACE BEVEL  256	SOLID SURFACE CUT & PLUG REPAIR SET  257
SOLID SURFACE WAVY JOINT  258	SOLID SURFACE NO-DRIP  260	SOLID SURFACE SINK & TRIM  259-260	ROUTER BIT SETS  261-271
STRAIGHT  273	PATTERN  274	FLUSH TRIM  274	ROUND NOSE  274
V-GROOVE  275	DECORATIVE  275	KEYHOLE  275	DOVETAIL  276
SLOT CUTTER  276	CHAMFER  276	RABBETING  277	COVE  277
OVOLO  277	ROUNDOVER & BEADING  278	OGEE  278-279	ROUTER BIT SETS  279

Routing Guide

CUTTING EDGE TYPE

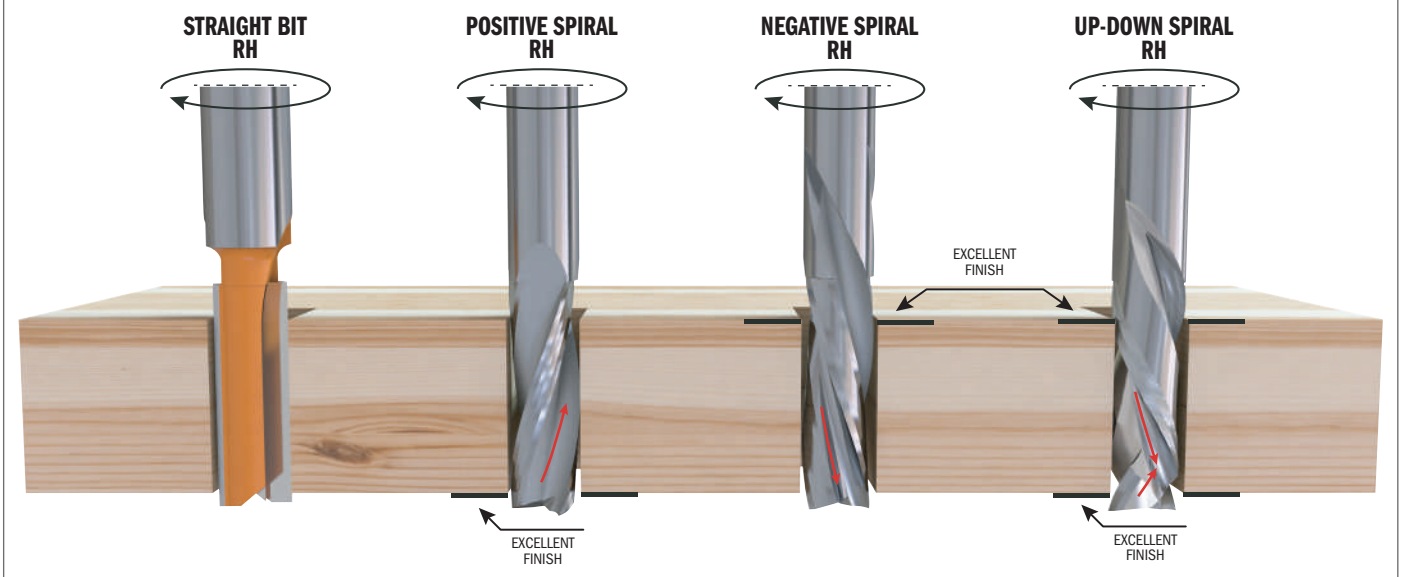

RECOMMENDED PLUNGING METHOD

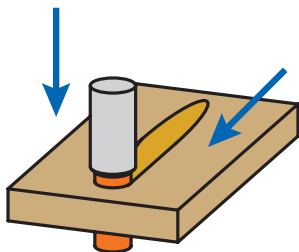

RAMP PLUNGING

These methods are recommended for sizing and grooving tools.

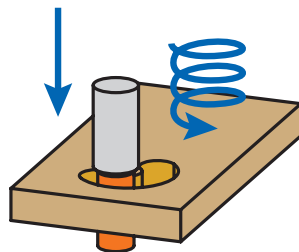

SPIRAL PLUNGING

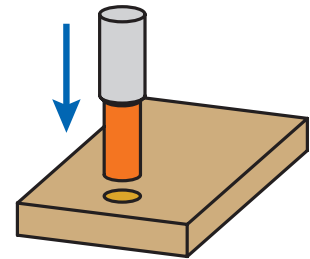

AXIAL PLUNGING

Router bits with mainly negative cutting shear angles, negative spiral, and router bits without plunging cutter are **NOT** suitable for axial plunging!

PROBLEM SOLVING

PROBLEM

Bad finishing
Cutting edge wear
Cutting edge burns
Cutting edge debris
Vibrations
Cutter breakage

SOLUTIONS

<ul style="list-style-type: none"> • Cutting depth • Vibrations
<ul style="list-style-type: none"> • Rotation speed • Vibrations
<ul style="list-style-type: none"> • Rotation speed • Number of cutting-edges
<ul style="list-style-type: none"> • Cutting depth
<ul style="list-style-type: none"> • Rotation speed • Cutting depth
<ul style="list-style-type: none"> • Feed speed • Cutting depth • Vibrations

INCREASE

<ul style="list-style-type: none"> • Rotation speed • Dust extraction • Number of cutting edges • Clamping cutter/chuck
<ul style="list-style-type: none"> • Feed speed
<ul style="list-style-type: none"> • Feed speed
<ul style="list-style-type: none"> • Rotation speed • Feed speed • Dust extraction
<ul style="list-style-type: none"> • Machine stability • Workpiece stability
<ul style="list-style-type: none"> • Shank diameter • Collet clamping • Change tool material (solid carbide or DENSIMET®)

DECREASE

WHAT'S THE SECRET TO FLAWLESS EDGE PROFILES WITH NO REWORK?

WOOD MAGAZINE **Best Overall**
WOOD'S CHOICE 1994
ROUTER BITS

CMT Overall Rating 10!
Top Performing Router Bits



**MULTI-AXIS GRINDING
 CREATES A 3X LONGER
 LASTING MIRROR FINISH**

Each cutting edge is precisely sharpened to the micron, in order to produce a cutting angle, which is razor sharp, yet extremely durable.



ANTI-KICKBACK DESIGN

Controls depth of cut and minimizes the chance of kickback, reducing your risk of injury.



**SINTERHIP
 HI-DENSITY
 INDUSTRIAL CHROME
 CARBIDE**

New process called SinterHIP (Hot Isostatic Pressing), helps prevent material failure and increases cutting life.

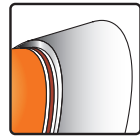

TRI-METAL BRAZING

Our Silver-Copper-Silver brazing protects the carbide tip when cutting harder wood or wood composites and reduces the chance of failed welds.



**NON-STICK
 ORANGE SHIELD
 COATING®**

Prevents bit from heating up, reduces pitch build-up, protects against corrosion and provides a longer bit life.



DELUXE PACKAGING



**SUPERIOR
 HIGH-STRENGTH STEEL**

We use high-quality, solid bar stock sourced from Switzerland, which provides exceptional resistance to fatigue and abrasion.

BUILDING THE WORLD'S FINEST CUTTING TOOLS

We built our foundations and reputation for high quality tools on the craftsman-like manufacturing of boring bits and router bits. Times have changed and current technology has completely altered the industry. As a result, our facilities have been newly renovated and our equipment today represents the most advanced technology available on the market. This allows us to continue to manufacture cutting tools with the skill and care that we always have.

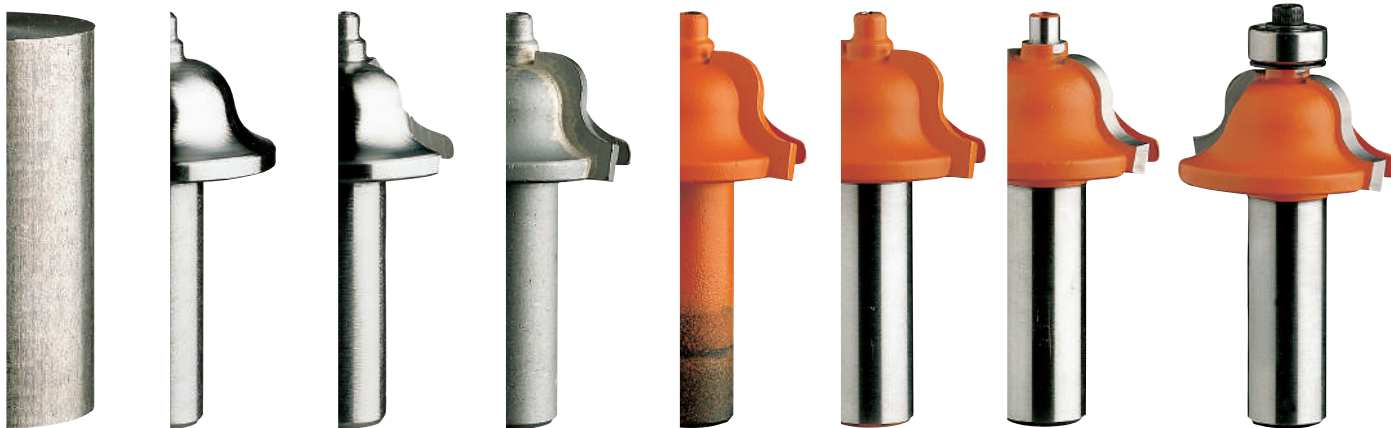

DESIGN

We engineer all of our products with a purpose in mind. Years of developing high performance cutting tools means that our top-sellers are tried and true, the result of continued perfection of each design, but we don't stop there: new materials, new profiles and new methods continue to emerge everyday.

At CMT, our objective is to remain on the cutting edge of innovation so our technical department ensures to continually monitor market developments, incorporate state-of-the-art software and apply experience in the sector to designs tools that are worthy of the CMT brand.

MATERIALS

Essentially, the main components of a router bit are just two: steel and carbide. If either of these is less than the best, the tool we make will show it.

We've researched steel and carbide since the beginning, and found exactly what we were looking for:

Superior Steel. Our steel is comes from right above the border in Switzerland where an exclusive hot drawing process is applied to forge the solid bar stock we use to manufacture our shanks and bodies.

The result? Steel that is superior in strength and exceptionally resistant to fatigue and abrasion.

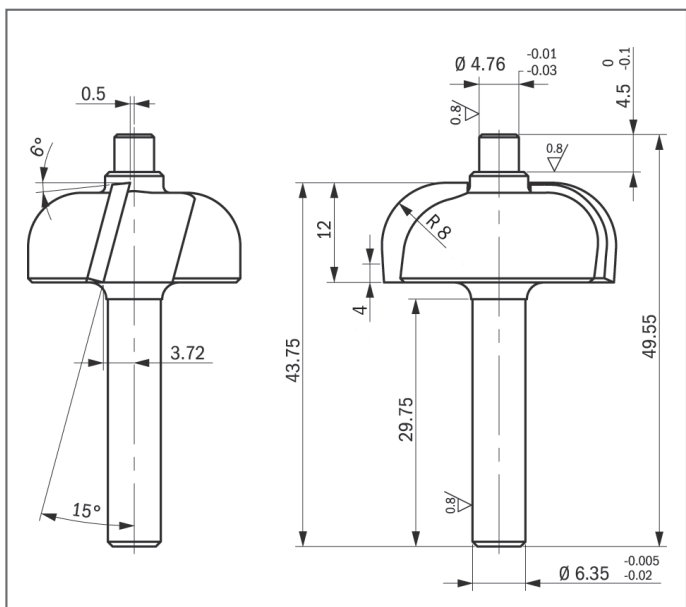

High-Grade Tungsten Carbide. If steel is what gives our tools strength, carbide is what gives them intelligence. The capacity of the carbide tip to cut precisely and to last a long time is critical for the performance of any tool, so at CMT we use only premium micrograin carbide from Luxembourg to make the tips for our router bits.

MANUFACTURING

Turning, Milling and Cutting. Our biggest investment in recent years has been in upgrading production. Today, all machinery at CMT is fully automated. CNC machines run by specially trained operators who make sure that the shanks and bodies of our router bits and boring bits are accurate and perfectly balanced.

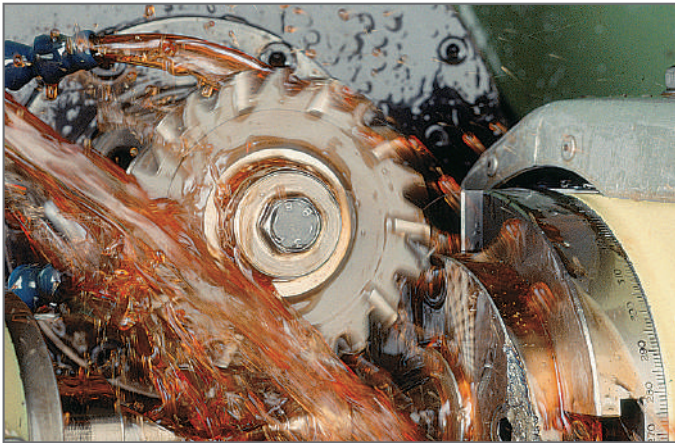

Heat Forged Steel Bodies for Large Diameter Bits. No router bits are exactly the same, sometimes not even in the way they are made. Certain bits require a few more steps than others, like heat forging the steel of larger diameter bits before turning it down into precise bit bodies. This extra step produces a radial grain orientation which gives large diameter bits extra strength and durability.

Brazing. We have pioneered the art of brazing. Not only does our unique custom-designed computerized brazing equipment help eliminate the inconsistencies found in old fashioned hand brazing, but our silver-copper-silver brazing 'sandwich' provides a tight bond between the steel and the carbide, with a shock absorbing effect to protect the carbide tips when cutting harder woods.

Specially Formulated Carbide for Specific Applications. You have to cut every kind material, so we make sure that our carbide tips can handle each individual job. This means specially formulating the carbide of each tool so that the compositions vary from being super hard (for tough cutting jobs like laminates) to being

less hard (to absorb the impact when cutting large profiles) and everything in between.

Grinding and Sharpening. The final step in the production process is no different from the rest: sharpening and grinding are done to extreme precision on multi-axis CNC machines. Each bevel and angle is ground or sharpened to the micron, to produce a cutting edge that is both razor sharp yet extremely durable.



680°C in seconds - and the brazing is complete.

QUALITY CONTROL

Even the simplest of tasks can include a margin for error. However at CMT, we take measures to prevent this. We always manually check the quality of our tools at each step of the manufacturing process, and we still make test cuts with rail & stile bits to make sure the cut fits. However, now we also use a fully automatic measuring process that evaluates every part of the tool without actually coming into contact with it, to make sure that the tool dimensions are accurate and that the profiles conform precisely to technical specification. We also use this system to gauge the wear and tear on the CNC machines.



CMT's fully automatic measuring system.

Solid Carbide Spiral Bits - LONG LIFE

Thanks to the spiral cutting edge which stays in continuous contact with the workpiece, these bits provide smoother, chatter-free cutting action, unlike conventional bits which have intermittent contact with the workpiece. Unsurpassed performance and cleaner cuts in ordinary or difficult materials, softwood, hardwood, plywood, composites etc. This new range of spiral bits with 6 - 8 - 12mm and 6,35 - 12,7mm shanks allow them to be used with a CNC router and hand-held routers. **Excellent quality-price ratio!**



190.41 UPCUT & DOWNCUT SPIRAL - DLCS Chrome Coating



D mm	I mm	I1 Pos. mm	L mm	Z		ORDER NO. S=Ø8mm	ORDER NO. S=Ø9,52mm	ORDER NO. S=Ø10mm	ORDER NO. S=Ø12mm	ORDER NO. S=Ø12,7mm
8	32	7	80	2+2	10	190.080.41				
9,52	28,6	7	76,2	2+2	10		190.504.41			
10	32	7	80	2+2	10			190.100.41		
10	42	7	90	2+2	10			190.101.41		
12	42	7	90	2+2	10				190.120.41	
12	52	7	100	2+2	10				190.121.41	
12,7	25,4	12	76,2	2+2	10					190.505.41
12,7	28,6	12	76,2	2+2	10					190.506.41
12,7	34,9	12	88,9	2+2	10					190.507.41
12,7	41,3	12	101,6	2+2	10					190.508.41

UP & DOWNCUT MORTISING BITS

9,52	22,2	4,8	76,2	2+2	10		190.513.41			
9,52	25,4	5,2	76,2	3+3	10		190.813.41			
12	25,4	5,2	83	3+3	10				190.320.41	
12,7	22,2	5,2	76,2	2+2	10					190.515.41
12,7	34,9	5,2	88,9	2+2	10					190.517.41
12,7	28,5	6	76,2	3+3	10					190.815.41



190 UPCUT & DOWNCUT SPIRAL



D mm	I mm	I1 Pos. mm	L mm	Z		ORDER NO. S=Ø6,35mm	ORDER NO. S=Ø8mm	ORDER NO. S=Ø9,52mm	ORDER NO. S=Ø10mm	ORDER NO. S=Ø12mm	ORDER NO. S=Ø12,7mm
6,35	22,2	7	63,5	2+2	10	190.008.11					
8	32	7	80	2+2	10		190.080.11				
9,52	28,6	7	76,2	2+2	10			190.504.11			
10	32	7	80	2+2	10				190.100.11		
10	42	7	90	2+2	10				190.101.11		
12	42	7	90	2+2	10					190.120.11	
12	52	7	100	2+2	10					190.121.11	
12,7	25,4	12	76,2	2+2	10						190.505.11
12,7	28,6	12	76,2	2+2	10						190.506.11
12,7	34,9	12	88,9	2+2	10						190.507.11
12,7	41,3	12	101,6	2+2	10						190.508.11

UP & DOWNCUT MORTISING BITS

9,52	22,2	4,8	76,2	2+2	10			190.513.11			
9,52	25,4	5,2	76,2	3+3	10			190.813.11			
12	25,4	5,2	83	3+3	10					190.320.11	
12,7	22,2	5,2	76,2	2+2	10						190.515.11
12,7	34,9	5,2	88,9	2+2	10						190.517.11
12,7	28,5	6	76,2	3+3	10						190.815.11

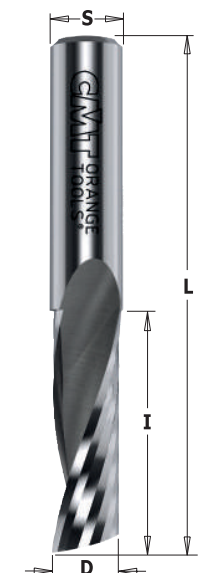

198 UPCUT



D mm	I mm	L mm		ORDER NO. S=Ø6mm	ORDER NO. S=Ø6,35mm	ORDER NO. S=Ø8mm	ORDER NO. S=Ø12mm
3,18	12,7	50,8	10		198.001.11		
4,76	15,87	50,8	10		198.005.11		
6	22	60	10	198.060.11			
6,35	19,05	50,8	10		198.007.11		
6,35	25,4	63,5	10		198.008.11		
8	22	70	10			198.080.11	
8	32	80	10			198.081.11	
12	32	83	10				198.120.11





191 UPCUT SPIRAL



D mm	I mm	L mm		ORDER NO. S=Ø6mm	ORDER NO. S=Ø6,35mm	ORDER NO. S=Ø8mm	ORDER NO. S=Ø12mm	ORDER NO. S=Ø12,7mm
3	12	60	10	191.630.11		191.830.11		
3,18	12,7	50,8	10		191.001.11			
3,5	12	60	10	191.635.11				
3,97	12,7	50,8	10		191.003.11			
4	15	60	10	191.640.11		191.840.11		
4,76	19,05	50,8	10		191.005.11			
5	17	60	10	191.650.11		191.850.11		
6	27	70	10	191.060.11		191.860.11		
6,35	19,05	50,8	10		191.007.11			
6,35	25,4	63,5	10		191.008.11			
7	32	80	10			191.870.11		
7,94	25,4	76,2	10					191.501.11
8	22	70	10			191.080.11		
8	32	80	10			191.081.11		
8	42	90	10			191.082.11		
9	32	83	10				191.890.11	
9,53	31,75	82,5	10					191.503.11
10	32	80	10			191.800.11		
10	32	83	10				191.900.11	
10	42	90	10				191.901.11	
12	35	83	10			191.820.11	191.120.11	
12	42	90	10				191.121.11	
12	52	100	10				191.122.11	
12,7	31,75	76,2	10					191.505.11
12,7	38,1	88,9	10					191.506.11
12,7	50,8	101,6	10					191.507.11



Excellent finish

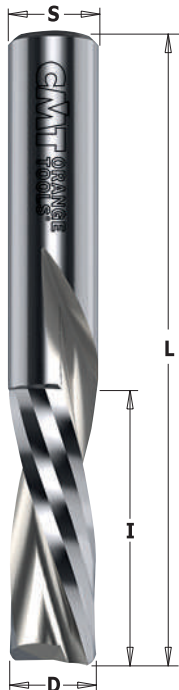

192 DOWNCUT SPIRAL



D mm	I mm	L mm		ORDER NO. S=Ø6mm	ORDER NO. S=Ø6,35mm	ORDER NO. S=Ø8mm	ORDER NO. S=Ø12mm	ORDER NO. S=Ø12,7mm
3	12	60	10	192.630.11		192.830.11		
3,18	12,7	50,8	10		192.001.11			
3,97	12,7	50,8	10		192.003.11			
4	15	60	10	192.640.11		192.840.11		
4,76	19,05	50,8	10		192.005.11			
5	17	60	10	192.650.11		192.850.11		
6	27	70	10	192.060.11		192.860.11		
6,35	19,05	50,8	10		192.007.11			
6,35	25,4	63,5	10		192.008.11			
7,94	25,4	76,2	10					192.501.11
8	22	70	10			192.080.11		
8	32	80	10			192.081.11		
8	42	90	10			192.082.11		
9,53	31,75	82,5	10					192.503.11
10	32	80	10			192.800.11		
10	32	83	10				192.900.11	
12	35	83	10			192.820.11	192.120.11	
12,7	31,75	76,2	10					192.505.11
12,7	38,1	88,9	10					192.506.11
12,7	50,8	101,6	10					192.507.11



Excellent finish



192.41 DLCS Chrome Coating (See page 295)





174 - 177 - 912

These industrial straight bits are made from stainless steel specifically created to withstand rigorous workloads on hand-held or CNC routers. The two lateral cutting edges allow you to execute any kind of plunge drilling and trimming jobs on solid, soft or hardwood, wood composite and plastic or laminated materials.

APPLICATION: - soft and hardwood and wood composite
- chipboard, MDF (laminated & melamine)
- plywood, veneer, ecc.

PLUNGE CENTRE TIP Z2+1

The special carbide-tipped cutting edge guarantees long-lasting performance compared to traditional bits.

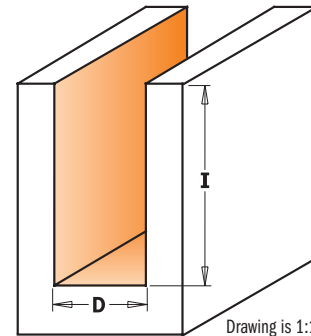

Drawing is 1:1 scale

177

D mm	I mm	L mm		ORDER NO. S=Ø12mm
10	35	90	10	177.100.11
12	35	90	10	177.120.11
12	50	100	10	177.121.11
14	35	90	10	177.140.11
16	35	90	10	177.160.11
16	60	110	10	177.161.11
18	35	90	10	177.180.11
18	60	110	10	177.181.11
20	35	90	10	177.200.11
22	35	90	10	177.220.11
24	35	90	10	177.240.11
25	35	90	10	177.250.11
26	35	90	10	177.260.11
28	35	90	10	177.280.11
30	35	90	10	177.300.11
35	35	90	10	177.350.11

912

D mm	I mm	L mm		ORDER NO. S=Ø12mm
12	70	110	10	912.623.11

Carefully make several shallow passes to prevent damaging the tool.
The warranty does not cover improper use of the tool.

PLUNGE CENTRE TIP Z2+1

The special carbide-tipped cutting edge guarantees long-lasting performance compared to traditional bits.



174

D mm	I mm	L mm		ORDER NO. S=Ø8mm
• 3	10	55	10	174.030.11
• 4	10	55	10	174.040.11
• 5	12	55	10	174.050.11
• 6	14	55	10	174.060.11
• 7	20	55	10	174.070.11
8	20	55	10	174.080.11
8	30	70	10	174.081.11
8	40	90	10	174.082.11
9	20	55	10	174.090.11
10	20	60	10	174.100.11
10	30	70	10	174.102.11
10	40	90	10	174.101.11
11	20	60	10	174.110.11
12	20	60	10	174.120.11
12	30	70	10	174.122.11
12	40	90	10	174.121.11
13	20	60	10	174.130.11
14	20	60	10	174.140.11
14	30	70	10	174.142.11
14	40	90	10	174.141.11
15	20	60	10	174.150.11
16	20	70	10	174.160.11
16	30	70	10	174.162.11
16	40	90	10	174.161.11
18	20	70	10	174.180.11
18	30	70	10	174.181.11
18	40	80	10	174.182.11
19	20	70	10	174.190.11
20	20	70	10	174.200.11
20	30	70	10	174.201.11
20	40	90	10	174.202.11
22	20	70	10	174.220.11
22	30	70	10	174.221.11
22	40	90	10	174.222.11
23,5	20	70	10	174.235.11
24	20	70	10	174.240.11
24	30	70	10	174.241.11
24	40	90	10	174.242.11
25	20	70	10	174.250.11
26	20	70	10	174.260.11
26	30	70	10	174.261.11
28	20	70	10	174.280.11
28	30	70	10	174.281.11
29	20	70	10	174.290.11
30	20	70	10	174.300.11
32	20	70	10	174.320.11

• HWM

Straight Bits, Long Series

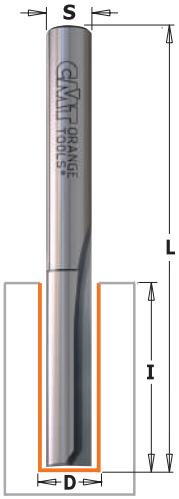

7/8/912

SAFETY PRECAUTIONS: never use damaged or worn bits. Always work at the recommended proper feed rate without forcing the bit. Pay particular attention when making the initial cut with a small diameter bit. For best results when working with small diameter bits, make the cut in more than one pass.

The sharpened cutting edge is perfect for short plunging operations



HWM HW Z2 Z3 RH

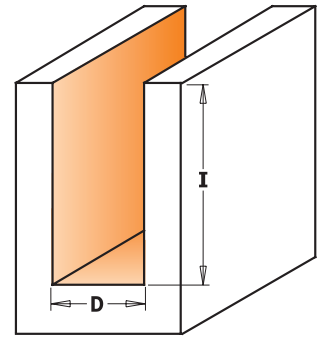

Z3 for Nesting

• HWM

D mm	I mm	L mm		ORDER NO. S=Ø6mm	ORDER NO. S=Ø6,35mm	ORDER NO. S=Ø8mm	ORDER NO. S=Ø10mm	ORDER NO. S=Ø12mm	ORDER NO. S=Ø12,7mm
• 3	11	60	10	712.030.11					
• 3,2	12,7	50,8	10		812.032.11				
• 4	12	60	10	712.040.11					
• 5	18	60	10	712.050.11					
• 6	25,4	60	10	712.060.11	812.060.11	912.060.11			
• 6,35	25,4	60	10		812.064.11				
• 8	31,7	60	10	712.080.11	812.080.11	912.080.11			
• 8	31,7	75	10					912.580.11	
9	31,7	75	10					912.590.11	
9,5	31,7	63,5	10		812.095.11				
9,5	31,7	73	10						812.595.11
10	31,7	60	10	712.100.11	812.100.11	912.100.11			
10	31,7	70	10						812.600.11
10	31,7	74	10					912.600.11	
11,1	31,7	82,5	10						812.611.11
12	31,7	60	10	712.120.11	812.120.11	912.120.11			
12	31,7	70	10						812.620.11
12	38,1	95	10					912.621.11	812.621.11
12	50,8	108	10					912.622.11	
12,7	31,7	70	10		812.127.11	912.127.11			
12,7	38,1	95	10						812.627.11
12,7	50,8	108	10						812.628.11
12,7	63,5	111	10						812.629.11
14	31,7	60	10	712.140.11	812.140.11	912.140.11			
14	31,7	70	10					912.640.11	
15	31,7	66	10	712.150.11	812.150.11	912.150.11			
15	31,7	70	10					912.650.11	
15,8	31,7	70	10		812.158.11				
16	31,7	66	10	712.160.11	812.160.11	912.160.11			
16	31,7	70	10					912.660.11	812.660.11
18	38,1	80	10					912.681.11	
19	38,1	82,5	10					912.690.11	812.690.11
19	50,8	92	10					912.691.11	812.691.11
20	38,1	80	10					912.701.11	
22	38,1	80	10					912.721.11	
BULK PACK 10 PCS.									
6,35	25,4	60			812.064.11-X10				
12,7	50,8	108							812.628.11-X10
FOR INDUSTRIAL NESTING APPLICATION [Z3] - DLCS CHROME LONG-LIFE COATING									
• 6	21	73	10					912.561.11	
• 6	26	73	10					912.560.11	
• 6,35	26	73	10						812.564.11
• 8	21	73	10					912.582.11	
• 8	28,7	76	10					912.581.11	812.581.11
• 8	32	76	10					912.583.11	
• 10	21	75	10				912.610.11		
• 10	32	75	10				912.611.11		

Straight Bits

HWM HW Z1 Z2 RH

7/8/911

If you are looking to get the most out of your time and money through more efficient production, but want nothing This double edged cutter is made of special FATIGUE-PROOF® steel and micrograin carbide to withstand even the heaviest of workloads. The surface is protected with our trademark orange non-stick P.T.F.E. coating to help keep the bit from collecting resin, pitch and other residue.

Every bit is subject to strict quality tests to guarantee perfect cutting tolerance, balance and concentricity. You can also count on exceptional swarf removal to allow cleaner and more constant cutting. CMT bits are perfect for industrial scale production using a variety of materials such as plywood, composites and natural woods.



The sharpened cutting edge is perfect for short plunging operations.

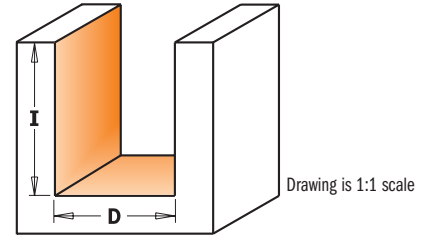

Drawing is 1:1 scale

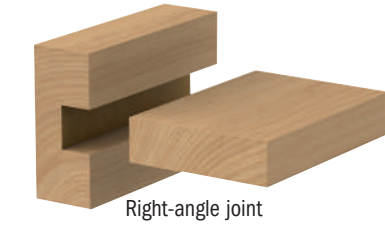

Right-angle joint



Biscuit joint
#7/8/911.040.11

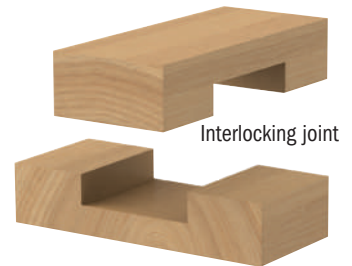

Interlocking joint

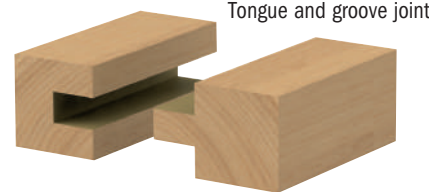

Tongue and groove joint

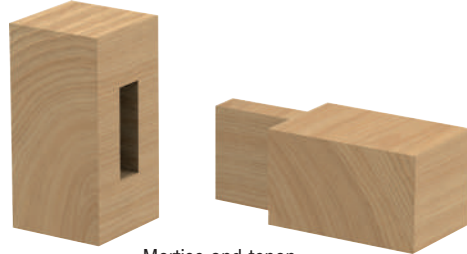

Mortise and tenon

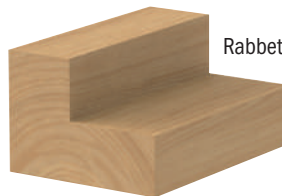

Rabbet

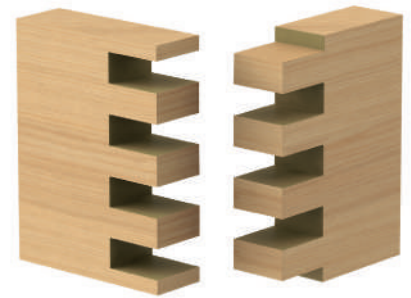

Finger joint

Plywood Groove Set

HWM HW Z2 RH

811

These groove bits are specifically designed to rout grooves and dados for joints in plywood. This means they match the true thickness of the material, producing tight, accurate joints. Use our 18.2mm bit for 19mm plywood, 12.3mm bit for 12.7mm plywood and our 6mm bit for 6.35mm plywood. No sloppy joints. No worries! These money-saving 3-bit sets are available with 12.7mm or 6.35mm shanks.

EXAMPLE SHOWN IN 12,7MM THICK PLYWOOD

This joint is made with the CMT 12,3mm straight bit for 12,7mm plywood. Notice the precise fit - no gaps.

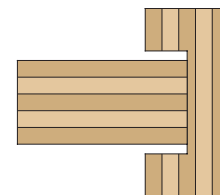
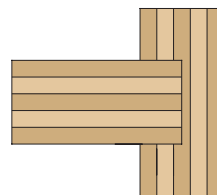

This joint is made with a regular 12,7mm straight bit for 12,7mm plywood. Notice the extra space and poor joint fit.



DESCRIPTION		ORDER NO. S=Ø6,35mm	ORDER NO. S=Ø12,7mm
Plywood Groove Set (Ø6 - Ø12,3 - Ø18,2mm)	5	811.001.11	811.501.11

Straight Bits - Short Series

D mm	I mm	L mm		ORDER NO. S=Ø6mm	ORDER NO. S=Ø6,35mm	ORDER NO. S=Ø8mm	ORDER NO. S=Ø12mm	ORDER NO. S=Ø12,7mm
• 2*	4	45	10	711.020.11	811.020.11			
• 3	8	45	10	711.030.11	811.030.11			
• 3	8	50	10			911.030.11		
• 3	8	58,3	10				911.530.11	
• 3,2	9,5	45	10		811.032.11			
• 4	10	58,3	10				911.540.11	
• 4	10	45	10	711.040.11	811.040.11			
• 4	10	50	10			911.040.11		
• 4,75	12,7	50,8	10		811.047.11			
• 5	12	50	10	711.050.11	811.050.11	911.050.11		
• 5	12	58,3	10				911.550.11	
• 6	16	50	10	711.060.11	811.060.11	911.060.11		
• 6	19	63,5	10				911.560.11	811.560.11
• 6,35	19	50,8	10		811.064.11			
• 6,35	19	57,2	10		811.065.11			
• 6,35	19	63,5	10					811.564.11
• 7	18	49	10	711.070.11	811.070.11	911.070.11		
• 7	18	63,5	10				911.570.11	
• 7,6	20	50	10			911.076.11		
• 8	20	50	10	711.080.11	811.080.11	911.080.11		
• 8	25,4	70	10		811.081.11			
• 8	25,4	70	10					811.581.11
9	20	48	10	711.090.11		911.090.11		
9,5	19	50,8	10		811.095.11			
9,5	25,4	63,5	10		811.096.11			
9,5	25,4	66,7	10					811.595.11
10	20	48	10	711.100.11	811.100.11	911.100.11		
10	25,4	63,5	10					811.600.11
11	20	48	10	711.110.11		911.110.11		
12	20	50	10	711.120.11	811.120.11	911.120.11		
12	25,4	63,5	10				911.620.11	811.620.11
12,3	25,4	57,2	10		811.123.11			
12,3	25,4	63,5	10					811.623.11
12,7	19	57,2	10		811.127.11			
12,7	25,4	66,7	10					811.627.11
12,7	31,7	76,2	10					811.628.11
13	20	57	10	711.130.11		911.130.11		
14	20	50	10	711.140.11	811.140.11	911.140.11		
14,2	14,2	57,2	10		811.142.11			
15	20	57,2	10	711.150.11	811.150.11	911.150.11		
15,8	19	66,7	10		811.158.11			
15,8	25,4	63,5	10					811.660.11
16	20	57,2	10	711.160.11	811.160.11	911.160.11		
16	25,4	63,5	10					811.661.11
17	20	50	10	711.170.11				
18	20	50	10	711.180.11	811.180.11	911.180.11		
18,2	25,4	57,2	10		811.182.11			
18,2	25,4	63,5	10					811.682.11
19	20	57,2	10	711.190.11	811.191.11	911.190.11		
19	25,4	63,5	10					811.690.11
19,85	25,4	59	10					811.700.11
20	20	50	10	711.200.11	811.200.11	911.200.11		
22	20	57,2	10	711.220.11	811.220.11	911.220.11		
24	20	50	10	711.240.11		911.240.11		
25	20	50	10	711.250.11		911.250.11		
25,4	19	50,8	10		811.254.11			
25,4	31,7	76,2	10					811.754.11
28,5	31,7	76,2	10					811.785.11

• HWM

* Z1

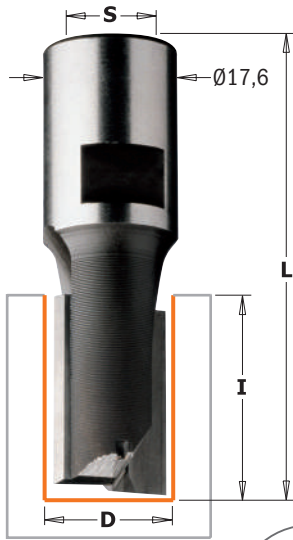

170 - 171 - 180 - 181



TECHNICAL DETAILS:

- Strength steel.
- 2 HW alternating precision ground cutting edges [Z2+1].

APPLICATION: ideal for groovework in solid wood, wood composites and laminates. Can be used on machining centres, CNC routers and hand-held routers equipped with chucks or adaptors.

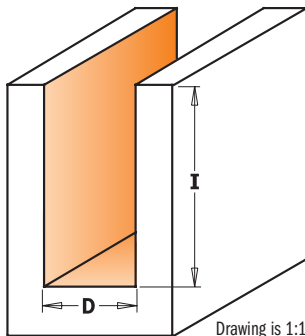

Drawing is 1:1 scale

D mm	I mm	L mm		ORDER NO. S=M12x1
6	18	60	1	170.060.11
8	23	60	1	170.080.11
10	23	60	1	170.100.11 ■
12	23	60	1	170.120.11
14	23	60	1	170.140.11
15	25	60	1	170.150.11
16	25	60	1	170.160.11
18	25	60	1	170.180.11
20	25	60	1	170.200.11
22	25	60	1	170.220.11
24	25	60	1	170.240.11
25	25	60	1	170.250.11
26	25	60	1	170.260.11
28	25	60	1	170.280.11
30	25	60	1	170.300.11
35	25	60	1	170.350.11
8	35	67	1	171.080.11
10	35	67	1	171.100.11
12	35	67	1	171.120.11
14	35	67	1	171.140.11
16	35	67	1	171.160.11
18	35	67	1	171.180.11
20	35	67	1	171.200.11
22	35	67	1	171.220.11
12	45	77	1	180.120.11
16	45	77	1	180.160.11
18	45	77	1	180.180.11
20	45	77	1	180.200.11
16	60	92	1	181.160.11
20	60	92	1	181.200.11

■ Until stock last

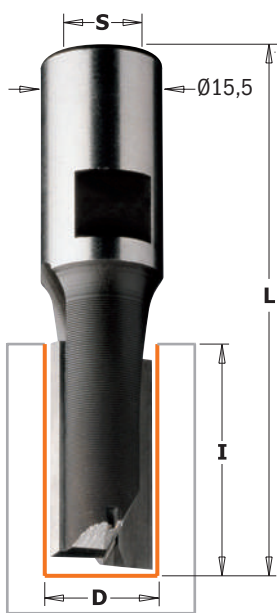

173 - 182



TECHNICAL DETAILS:

- Strength steel.
- 2 HW alternating precision ground cutting edges [Z2+1].

D mm	I mm	L mm		ORDER NO. S=M10x1,5
6	14	50	1	173.060.11
8	20	52	1	173.080.11
10	22	52	1	173.100.11
12	22	52	1	173.120.11
14	25	52	1	173.140.11
15	25	52	1	173.150.11
16	25	52	1	173.160.11
18	25	52	1	173.180.11
20	25	52	1	173.200.11
22	25	52	1	173.220.11
25	25	52	1	173.250.11
30	25	52	1	173.300.11
8	35	67	1	182.080.11
10	35	67	1	182.100.11
12	35	67	1	182.120.11
14	35	67	1	182.140.11
16	45	77	1	182.160.11
18	45	77	1	182.180.11
20	45	77	1	182.200.11

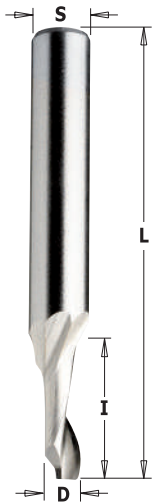

188

HSS Z1 RH

D mm	I mm	L mm		ORDER NO. S=Ø8mm
3	12	60	50	188.030.51
4	12	60	50	188.040.51
4	40	100	1	188.041.51
5	14	60	50	188.050.51
5	40	100	1	188.051.51
6	14	60	50	188.060.51
6	40	100	1	188.061.51
7	14	60	50	188.070.51
8	14	80	50	188.080.51
8	40	100	1	188.081.51
9	14	80	50	188.090.51
10	14	80	50	188.100.51
12	14	80	50	188.120.51

Suggested MAX RPM 12.000

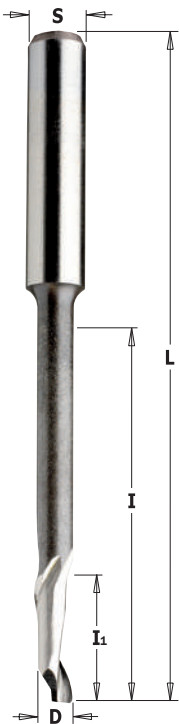

189 5% CO HSS SPIRAL BITS FOR HIGH CUTTING DEPTH

HSS Z1 RH

D mm	I mm	I1 mm	L mm	S mm		ORDER NO.
4	46	16	90	8	1	189.040.51
5	35	18	80	8	50	189.050.51
5	35	14	120	8	1	189.051.51
5	55	16	90	8	1	189.052.51
6	45	16	90	8	1	189.060.51
8	68	14	100	8	1	189.080.51
8	55	14	80	8	50	189.081.51
10	95	14	120	10	1	189.100.51
10	70	30	100	10	1	189.101.51

Suggested MAX RPM 12.000

TECHNICAL DETAILS:

- 5% Co premium solid HSS.
- 1 upcut spiral cutting edge.
- Upward chip ejection.

APPLICATION: for plunging, routing and trimming aluminium profiles, plastics with superb efficiency and high feed speed. Can be used on machining centres, aluminium copy routers, CNC and hand-held routers equipped with chucks or adaptors.



Solid Carbide Upcut Spiral Bits for Aluminium and PVC

186

MIRROR FINISH HWM Z2 RH

D mm	I mm	L mm	S mm		ORDER NO. Right-hand rotation
4	10	60	6	10	186.640.11
5	12	60	6	10	186.650.11
6	15	60	6	10	186.060.11
8	20	60	8	10	186.080.11
10	22	72	10	10	186.100.11
12	25	83	12	10	186.120.11
14	25	82	14	10	186.140.11
16	25	82	16	10	186.160.11

* with seat for seeger retention ring

TECHNICAL DETAILS:

- Premium quality HWM.
- 2 spiral cutting edges [Z2].
- Extra-fine finish.
- Upward chip ejection.

APPLICATION: used for plunging, routing and trimming on plastic and aluminum at high feed speed. Can be used on machining centers, point to point machines, CNC routers and hand held routers equipped with chucks

Straight Router Bits with Insert Knives

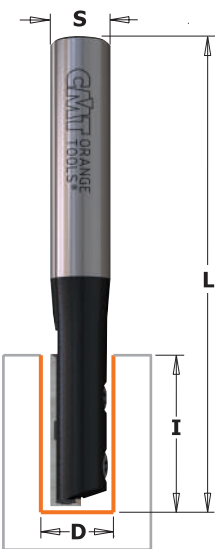

651 - 652

Straight router bit with one replaceable mini knife and fixing wedge. Radial and axial groove for better and safe knife insertion. For finishing, routing and grooving in board materials (DTD laminated, MDF and hardwood). For use on portable routers or CNC machining centres.



Drawing is 1:1 scale

SAFETY TIPS

The **TW-006** Torque Screwdriver is recommended for the proper fastening of screws (see page 413).

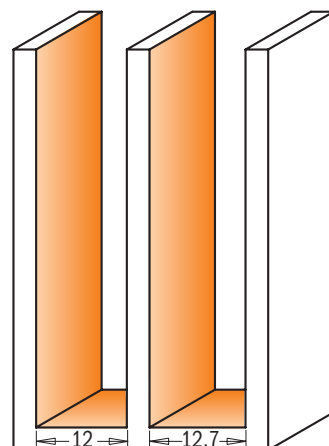
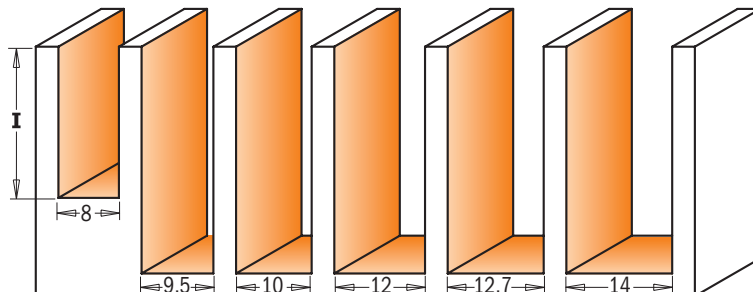

D mm	I mm	L mm	Box	ORDER NO. S=Ø6,35mm	ORDER NO. S=Ø8mm	ORDER NO. S=Ø12mm	ORDER NO. S=Ø12,7mm
8	20	60	10	651.079.11			
8	20	60	10		651.080.11		
8	20	67	10			651.081.11	651.681.11
9,5	30	80	10				651.695.11
10	30	70	10		651.100.11		
10	30	80	10			651.101.11	651.701.11
12	30	70	10		651.120.11		
12	30	80	10			651.121.11	651.721.11
12	50	103	10			652.121.11	652.621.11
12,7	30	70	10	651.127.11			
12,7	30	80	10				651.727.11
12,7	50	103	10				652.628.11
14	30	73	10		651.140.11		

Spare parts

Part	Part	Part	Part
790.200.01	651.999.01	990.070.00	991.063.00
790.200.01	651.999.01	990.070.00	991.063.00
790.200.01	651.999.01	990.070.00	991.063.00
790.300.01	651.999.02	990.071.00	991.063.00
790.300.01	651.999.02	990.071.00	991.063.00
790.300.01	651.999.02	990.071.00	991.063.00
790.300.01	651.999.02	990.071.00	991.063.00
790.300.01	651.999.02	990.071.00	991.063.00
790.500.01	651.999.03	990.016.00	991.060.00
790.300.01	651.999.02	990.071.00	991.063.00
790.300.01	651.999.02	990.071.00	991.063.00
790.500.01	651.999.03	990.016.00	991.060.00
790.300.01	651.999.02	990.071.00	991.063.00

Straight Router Bits with Insert Knives for Laminates

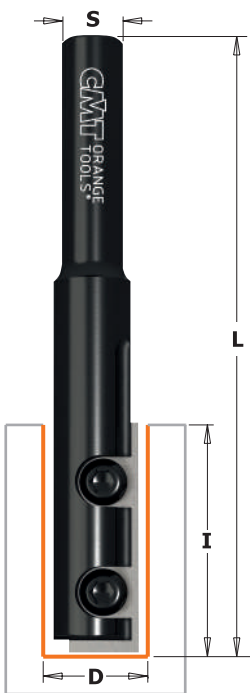

652

Straight trimmer bits with one replaceable knife fixed by a TORX® screw. A smart economical solution best suited for specialized applications requiring low downtime. The 29.5x9x1.5mm knives provide a 40mm cutting length by making multiple passes. For routing trimming and grooving on board materials (laminated chipboard, worktop panels and MDF). For use on portable routers.



SAFETY TIPS

The **TW-006** Torque Screwdriver is recommended for the proper fastening of screws (see page 413).

CORRECT KNIFE POSITIONING

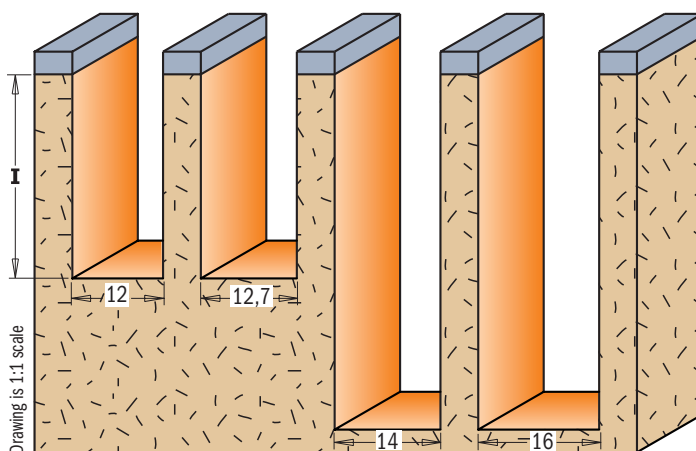
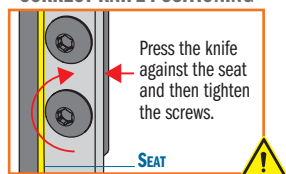

D mm	I mm	L mm	Box	ORDER NO. S=Ø8mm	ORDER NO. S=Ø12mm	ORDER NO. S=Ø12,7mm
12	29,5	79	10	652.120.11		
12	39,5	90	10	652.122.11		
12,7	29,5	89	10			652.627.11
14	50	96	10		652.141.11	
16	50	96	10		652.161.11	

Spare parts

Part	Part	Part
790.295.09	990.072.00	991.061.00
790.395.09	990.072.00	991.061.00
790.295.09	990.072.00	991.061.00
790.500.09	990.072.00	991.061.00
790.500.09	990.072.00	991.061.00

Straight Router Bits with Insert Knives



653

Straight router bits with a replaceable plunging knife and side knife fixed by a special TORX® screw. The tool bodies are precisely balanced. For finishing, routing, plunging and grooving on board materials (laminated chipboards and MDF) and hardwood. For use on portable routers or CNC machining centres.

SAFETY TIPS



The **TW-006** Torque Screwdriver is recommended for the proper fastening of screws (see page 413).



CORRECT KNIFE POSITIONING

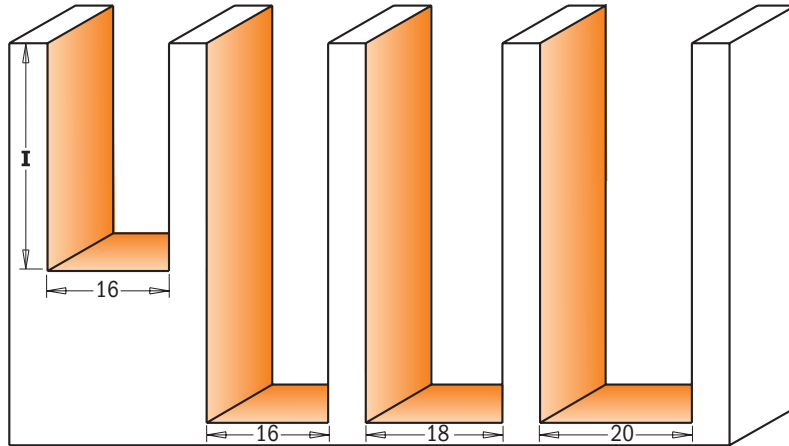
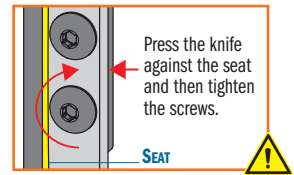

Drawing is 1:1 scale

D mm	I mm	L mm		ORDER NO. S=Ø8mm	ORDER NO. S=Ø12mm	ORDER NO. S=Ø12,7mm	ORDER NO. S=Ø20mm
15,8	28,3	92	10			653.158.11	
16	28,3	82	10	653.160.11			
16	28,3	92	10		653.161.11		653.661.11
16	48,3	111,5	10		653.162.11		653.662.11
18	48,3	111,5	10				653.681.11
20	48,3	111,5	10				653.701.11

Spare parts

790.283.12	990.074.00	990.075.00	790.075.00	990.072.00	991.061.00
790.283.12	990.074.00	990.075.00	790.075.00	990.072.00	991.061.00
790.283.12	990.074.00	990.075.00	790.075.00	990.072.00	991.061.00
790.483.12	990.074.00	990.075.00	790.075.00	990.072.00	991.061.00
790.483.12	990.074.00	990.075.00	790.075.00	990.072.00	991.061.00
790.483.12	990.074.00	990.075.00	790.096.00	990.072.00	991.061.00

Straight Router Bits with Insert Knives

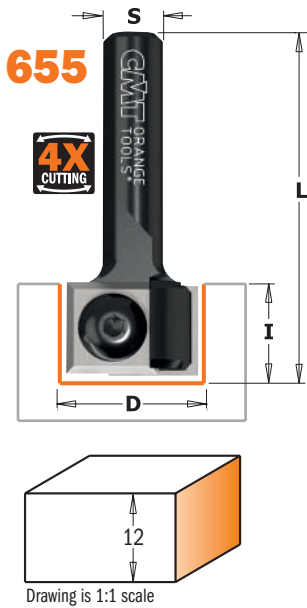

655



654



For finishing, routing, plunging and grooving on board materials (laminated chipboards and MDF) and hardwood. For use on portable routers, **point to point**, or CNC centres.



CORRECT KNIFE POSITIONING

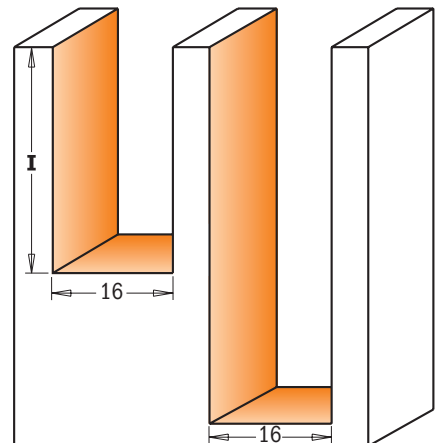
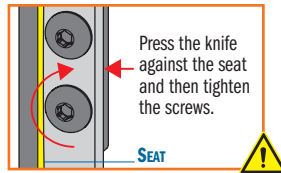

Drawing is 1:1 scale

SAFETY TIPS



The **TW-006** Torque Screwdriver is recommended for the proper fastening of screws (see page 413).

D mm	I mm	L mm		ORDER NO. S=Ø8mm	ORDER NO. S=Ø12mm	ORDER NO. S=Ø12,7mm	ORDER NO. S=Ø20mm
16	28,3	76	10	654.160.11			
16	28,3	87	10		654.161.11	654.661.11	
16	48,3	105	10		654.162.11		654.662.11
19	12	45	10	655.190.11			

Spare parts

790.283.12	990.073.00	991.061.00
790.283.12	990.073.00	991.061.00
790.483.12	990.073.00	991.061.00
790.120.00	990.075.00	991.061.00

Mortising Bits

7/8/901B



Perfectly mortised hinges are the sign of a true artisan. These bits equipped with thick Tungsten carbide tips and negative shear angle design, guarantee flawless performance. Mortise perfect hinges with no splintered edges or rough bottoms. Mortising is a breeze on both natural wood and wood composites. Compatible with most mortising jigs. Complete with a top bearing guide, these bits are the perfect tool for sign making and template work.

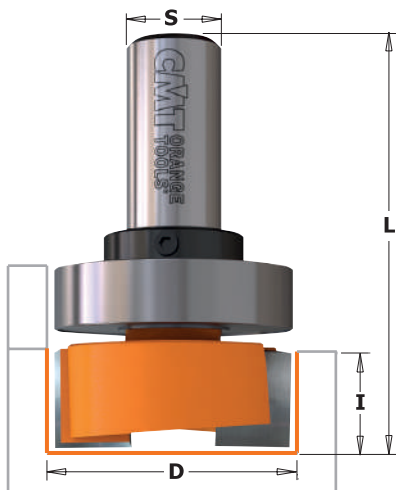

The CMT mortising bit is an essential tool for traditional hinge installation.

7/8/901

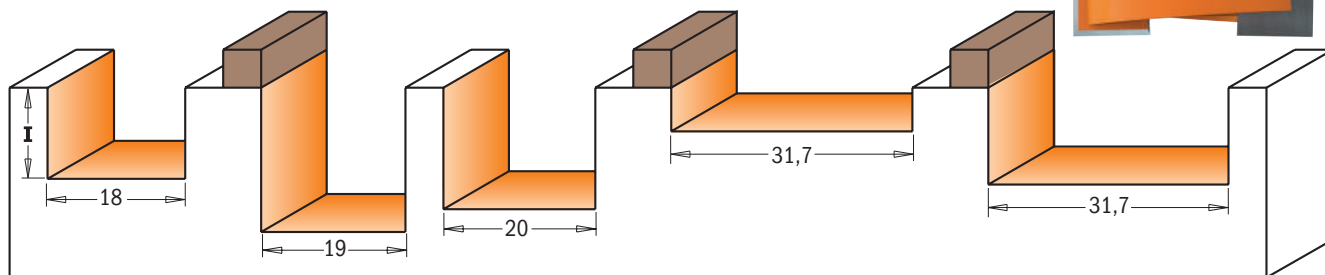
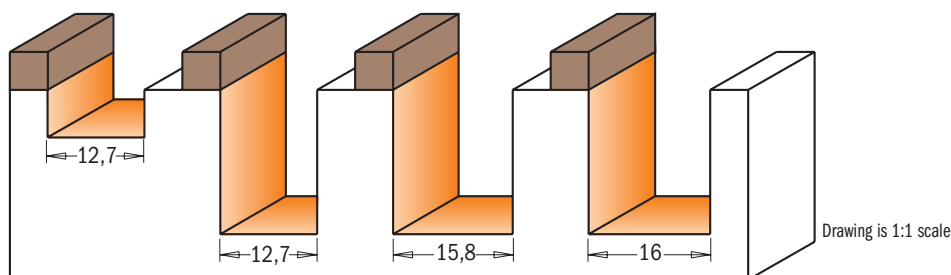

D mm	I mm	L mm		ORDER NO. S=Ø6mm	ORDER NO. S=Ø6,35mm	ORDER NO. S=Ø8mm	ORDER NO. S=Ø12mm	ORDER NO. S=Ø12,7mm
12,7	6,35	41	10		801.128.11			
12,7	19	54	10	701.127.11	801.127.11	901.127.11		
12,7	19	60	10				901.627.11	801.627.11
15,8	19	57	10		801.158.11			
16	19	54	10	701.160.11		901.160.11		
18	16	48	10	701.180.11		901.180.11		
19	19	54	10	701.190.11	801.190.11	901.190.11		
19	19	57	10					801.690.11
20	16	48	10	701.200.11		901.200.11		
31,7	5,7	63	10					801.818.11
31,7	12,7	48	10		801.317.11			
31,7	12,7	54	10				901.817.11	801.817.11
WITH TOP BEARING								
12,7	6,35	41	10		801.128.11B			
12,7	19	54	10		801.127.11B			
15,8	19	57	10		801.158.11B			
16	19	54	10			901.160.11B		
19	19	54	10	701.190.11B				
19	19	54	10		801.190.11B			
31,7	5,7	63	10					801.818.11B
31,7	12,7	54	10					801.817.11B

Spare parts		
791.010.00	541.001.00	991.056.00
791.010.00	541.001.00	991.056.00
791.009.00	541.001.00	991.056.00
791.025.00	541.004.00	991.056.00
791.007.00	541.003.00	991.056.00
791.004.00	541.001.00	991.056.00
791.015.00	541.002.00	991.056.00
791.015.00	541.002.00	991.056.00

Hinge Recesser Bits

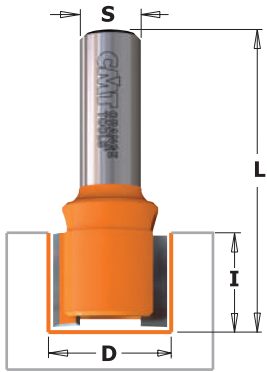

7/902



CMT hinge recesser bits are ideal for shallow lateral routing cuts such as recessing hinges.

SHOP TIPS: corners will require final square with a hand or a corner chisel.

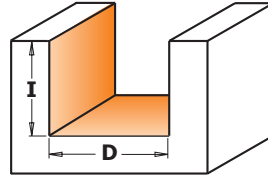

Drawing is 1:1 scale



IDEAL FOR HINGE RECESSING

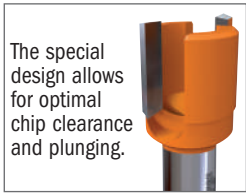

The special design allows for optimal chip clearance and plunging.

D mm	I mm	L mm		ORDER NO. S=Ø6mm	ORDER NO. S=Ø8mm
12	12	38	10	702.120.11	902.120.11
13	12	38	10	702.130.11	902.130.11
14	12	38	10	702.140.11	902.140.11
15	12	38	10	702.150.11	902.150.11
16	12	38	10	702.160.11	902.160.11
18	12	38	10	702.180.11	902.180.11
20	11	38	10	702.200.11	902.200.11
22	11	38	10	702.220.11	902.220.11
23	11	38	10	702.230.11	902.230.11
24	11	38	10	702.240.11	902.240.11
25	11	38	10	702.250.11	902.250.11

Dado & Planer Bits

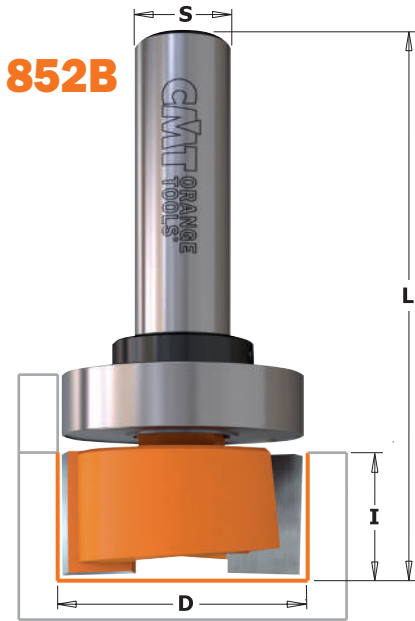

852B

This bit is perfect for smoothing baseboard and rough surfaces. Tungsten carbide tips and downward shear angle provide exceptional performance and quality. This bit can be used to remove paint and enamel residues. Also available with bearing for projects requiring high precision.

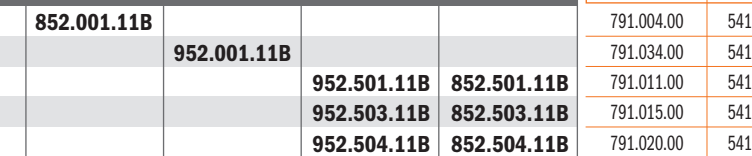
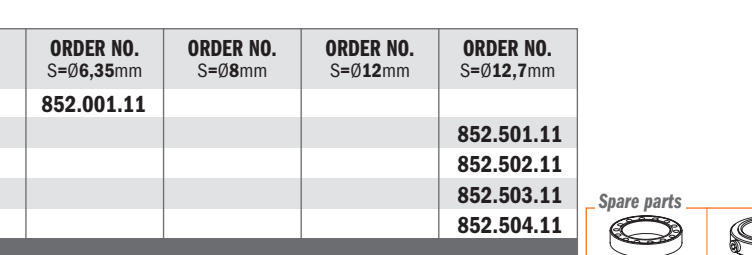
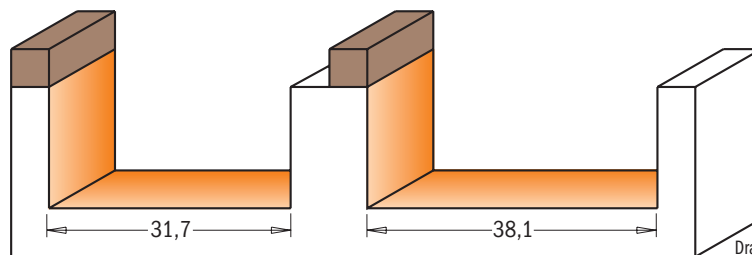
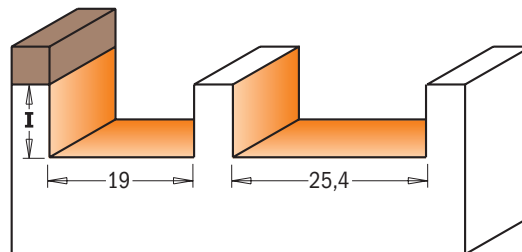

852



Drawing is 1:1 scale

D mm	I mm	L mm		ORDER NO. S=Ø6,35mm	ORDER NO. S=Ø8mm	ORDER NO. S=Ø12mm	ORDER NO. S=Ø12,7mm
19	9,5	57	10	852.001.11			
19	9,5	63,5	10				852.501.11
25,4	9,5	57	10				852.502.11
31,7	15,8	70	10				852.503.11
38,1	15,8	70	10				852.504.11
WITH TOP BEARING							
19	9,5	57	10	852.001.11B			
19	9,5	57	10		952.001.11B		
19	9,5	63,5	10			952.501.11B	852.501.11B
31,7	15,8	70	10			952.503.11B	852.503.11B
38,1	15,8	70	10			952.504.11B	852.504.11B

Spare parts

791.004.00	541.001.00	991.056.00
791.034.00	541.004.00	991.056.00
791.011.00	541.002.00	991.056.00
791.015.00	541.002.00	991.056.00
791.020.00	541.002.00	991.056.00



7/8/911B

These double-fluted bits paired with the template of your choice will produce distinctive cabinets, furniture pieces, signs, toys and personalize a variety of creative projects.

SAFETY TIPS: make sure your router is in top condition. The template must be securely fastened to the workpiece. When choosing a bit, carefully consider the thickness of the template and all the implications of the cut. Opt for the shortest bit possible for the project you are working on.

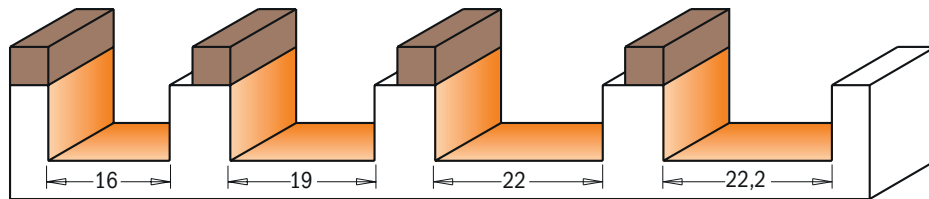
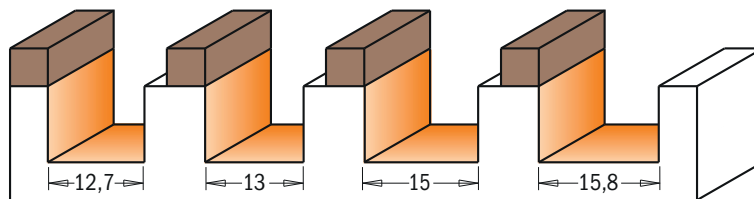
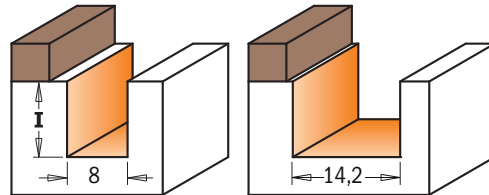
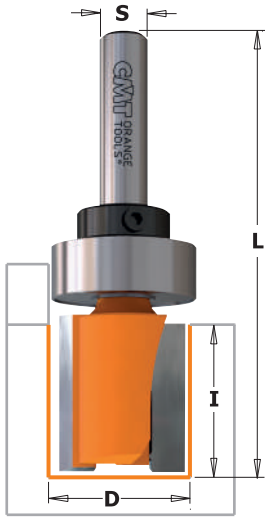

Drawing is 1:1 scale

7/8/912B



D mm	I mm	L mm		ORDER NO. S=Ø6mm	ORDER NO. S=Ø6,35mm	ORDER NO. S=Ø8mm	ORDER NO. S=Ø12mm	ORDER NO. S=Ø12,7mm
8	25,4	70	10		•811.081.11B			
12,7	19	57,2	10		811.127.11B			
13	20	57	10	711.130.11B				
14,2	14,2	57,2	10		811.142.11B			
15	20	57	10	711.150.11B				
15,8	12,7	58	10		811.159.11B			
15,8	19	66,5	10		811.158.11B			
16	20	57	10			911.160.11B		
19	20	57	10	711.190.11B				
19	20	57,2	10		811.191.11B			
19	25,4	63,5	10					811.690.11B
22	20	57	10			911.220.11B		
22,2	25,4	66,5	10					811.222.11B*
LONG SERIES								
12,7	31,7	70	10		812.127.11B			
15	31,7	66,5	10	712.150.11B				
15,8	31,7	70	10		812.158.11B			
16	31,7	66,5	10			912.160.11B		
19	38,1	82,5	10				912.690.11B	
19	38,1	82,5	10					812.690.11B
19	50,8	92	10				912.691.11B	
19	50,8	92	10					812.691.11B

Spare parts

791.010.00	541.001.00	991.056.00
791.010.00	541.001.00	991.056.00
791.023.00	541.003.00	991.056.00
791.009.00	541.001.00	991.056.00
791.024.00	541.003.00	991.056.00
791.009.00	541.001.00	991.056.00
791.009.00	541.001.00	991.056.00
791.009.00	541.001.00	991.056.00
791.025.00	541.004.00	991.056.00
791.007.00	541.003.00	991.056.00
791.004.00	541.001.00	991.056.00
791.011.00	541.002.00	991.056.00
791.005.00	541.004.00	991.056.00
791.021.00	541.006.00	991.056.00
791.010.00	541.001.00	991.056.00
791.024.00	541.003.00	991.056.00
791.009.00	541.001.00	991.056.00
791.025.00	541.004.00	991.056.00
791.011.00	541.005.00	991.056.00
791.011.00	541.002.00	991.056.00
791.011.00	541.005.00	991.056.00
791.011.00	541.002.00	991.056.00

•HWM

■ Item with larger diameter bearing

*Ø9,5mm shanks with Ø9,5/12,7mm bushings (799.001.00)

Pattern Router Bits with Insert Knives

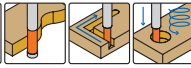
INSERT CARBIDE Z1 Z2 RH  2X CUTTING



652B

Straight router bits with a replaceable knife fixed by a TORX® screw. An economical solution for specialized applications requiring low downtime. Cut up to 40mm in depth by carrying out several passes. Equipped with top bearing for template use. For routing, trimming and grooving in board materials (laminated chipboards, MDF) and hardwood. For use on portable routers.

CORRECT KNIFE POSITIONING

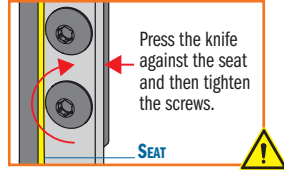





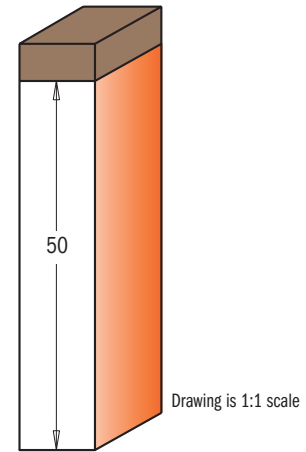

SAFETY TIPS

The **TW-006** Torque Screwdriver is recommended for the proper fastening of screws (see page 413).

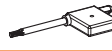

D mm	I mm	L mm	Z		ORDER NO. S=Ø12mm	ORDER NO. S=Ø12,7mm
19	49,5	100	1	10	652.690.11B	652.691.11B
28	50	100	2	10	652.786.11B	
28,6	50	100	2	10		652.787.11B

Spare parts

					
790.495.09	990.072.00	991.061.00	791.011.00	541.002.00	991.056.00
790.503.00*	990.076.00	991.061.00	791.026.00	541.005.00	991.056.00
790.503.00*	990.076.00	991.061.00	791.027.00	541.002.00	991.056.00

* 3 bore

Pattern Router Bits with Insert Knives for Laminates



656

Straight router bits with a replaceable knife fixed by a TORX® screw. The top knife features a 3° sharpened angle for plunge and high precision cuts. Equipped with top bearing for template use. For finishing, routing and grooving in board materials (laminated chipboards, MDF) and hardwood. For use on portable routers.

CORRECT KNIFE POSITIONING

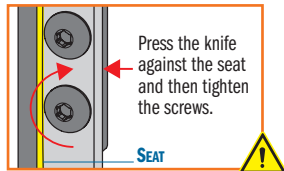

SAFETY TIPS



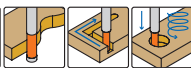

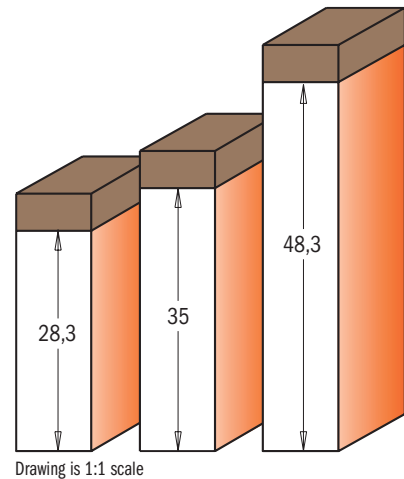

The **TW-006** Torque Screwdriver is recommended for the proper fastening of screws (see page 413).

INSERT CARBIDE Z2 RH  2X CUTTING

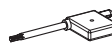

D mm	I mm	L mm		ORDER NO. S=Ø8mm	ORDER NO. S=Ø12mm	ORDER NO. S=Ø12,7mm
16	35	80	10	656.160.11		
19	28,3	69	10	656.190.11		
19	28,3	79	10			656.691.11
19	48,3	100	10		656.692.11	656.693.11

Spare parts

					
790.283.12	990.076.00	991.061.00	791.025.00	541.004.00	991.056.00
790.283.12	990.075.00	991.061.00	791.034.00	541.004.00	991.056.00
790.283.12	990.075.00	991.061.00	791.011.00	541.002.00	991.056.00
790.483.12	990.075.00	991.061.00	791.011.00	541.002.00	991.056.00

Weatherseal Bits

HWM Z2 RH



Make your house more energy efficient by insulating old doors and windows. The CMT Weatherseal bit is the perfect bit to re-groove door and window frames to accommodate wind blocking inserts. Made of solid tungsten carbide for strength and endurance, these bits reach up to 12mm in depth without the risk of breakage.

Special double-sided design lets you save money by offering two tips in one bit; with the same features as the one-sided weatherseal bit. Only available with a 3mm (1/8") cutting diameter.

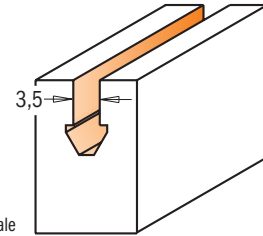
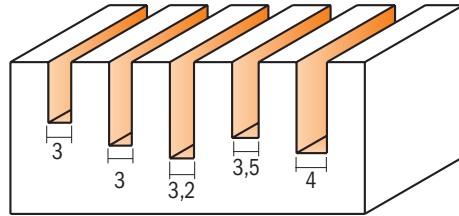

Drawing is 1:1 scale

712.030
712.040
812.032

711.031

D mm	I mm	L mm		ORDER NO. S=Ø6mm	ORDER NO. S=Ø6,35mm
3	8	76	10	711.031.11	
3	11	60	10	712.030.11	
3,2	12,7	50,8	10		812.032.11
3,5	12	60	10	191.635.11	
4	12	60	10	712.040.11	
3,5	8	76	10	713.001.11	
3,5	8	63,5	10		813.001.11



7/813.001

Combination Trimmer Bits

HW Z2 α RH

7/8/921

Work to your highest standards with the CMT combination trimmer bits. Now you can cut, trim and bevel all laminates without having to change the bit. Achieve great results when making straight or angled cuts on both soft and hardwood. Three popular sizes, each with carbide-tipped cutting edges for efficient bevel and straight trimming.

NOTICE: to be used with an edge, separate guide or fence.

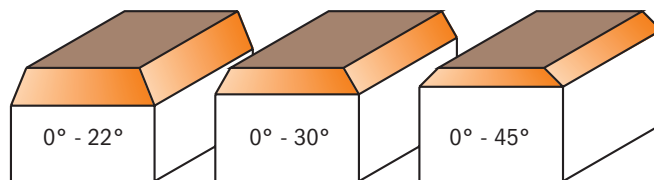
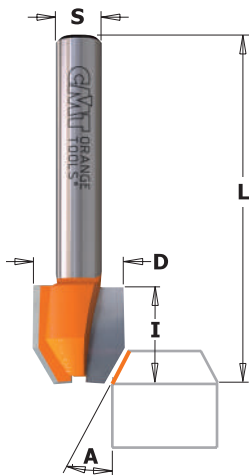

Drawing is 1:1 scale

A	D mm	I mm	L mm		ORDER NO. S=Ø6mm	ORDER NO. S=Ø6,35mm	ORDER NO. S=Ø8mm
0° - 22°	12	12,7	44,5	10	721.022.11	821.022.11	
0° - 30°	12	12,7	44,5	10	721.030.11	821.030.11	921.030.11
0° - 45°	12	12,7	44,5	10	721.045.11	821.045.11	

Combination Trimmer Bits

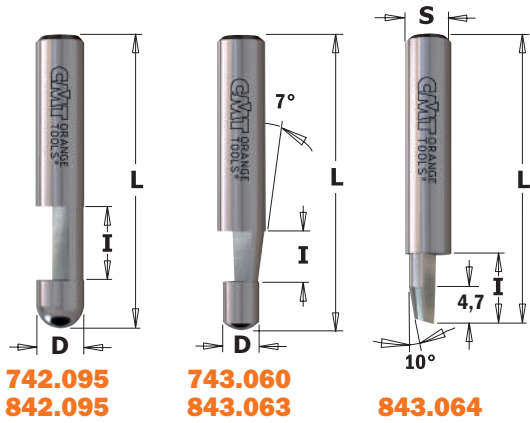

7/842 - 7/843



Work to your highest standards with CMT combination trimmer bits. Now you can cut, trim and bevel all laminates without having to change the bit. Achieve great results when making straight or angled cuts on both soft and hardwood. Three popular sizes, each with carbide-tipped edges, guarantee efficient bevels and straight trimming (7° or combined 0°-10°).

NOTICE: to be used with an edge, separate guide or fence.

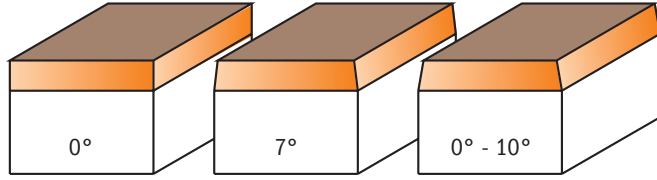

Drawing is 1:1 scale

A	D mm	I mm	L mm		ORDER NO. S=Ø6mm	ORDER NO. S=Ø6,35mm
0°	6	9,5	38	10	742.095.11	
0°	6,35	9,5	38	10		842.095.11
7°	4,5 - 6	6	38	10	743.060.11	
7°	4,76 - 6,35	6,35	38	10		843.063.11
0° - 10°	6,35	9,5	38	10		843.064.11
BULK PACK 50 PCS.						
0°	6,35	9,5	38			842.095.11-X50
7°	4,76 - 6,35	6,35	38			843.063.11-X50



BULK PACK 50 PCS.

Combination Trimmer Bits

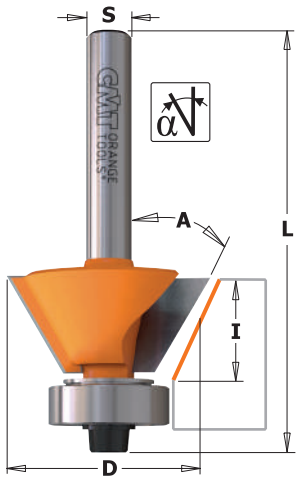

7/907 - 7/8/909 - 7/910

CMT's combination flush and bevel trim bits are perfect for executing a variety of superb precision finishing on laminates with ease without even changing the bit. Simply lower the bit cutting depth for precise right angle cuts or raise to 25° to create rounded edges. Suitable for both soft and hardwood. They feature two flutes for executing smoother cuts and for rounding off table legs and other soft areas on furniture susceptible to damage.

SHOP TIPS: after resharpening, replace bearing 791.002.11 (Ø9,5mm) with undersized bearing 791.062.00 (Ø9,3mm)

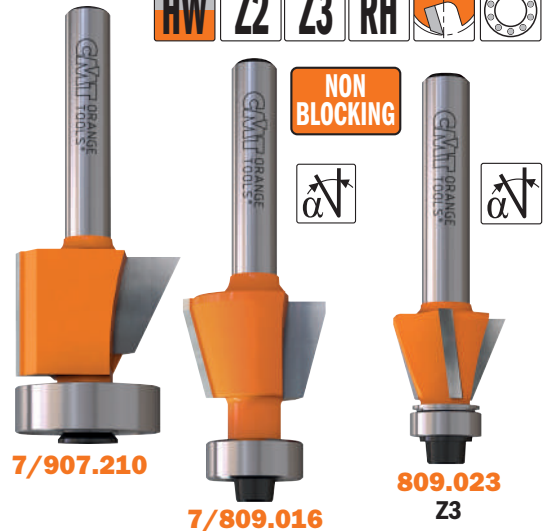

809.022
809.025
7/909.260
7/910.260

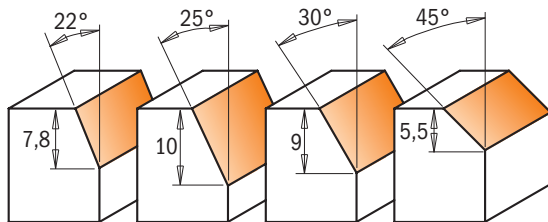

Drawing is 1:1 scale

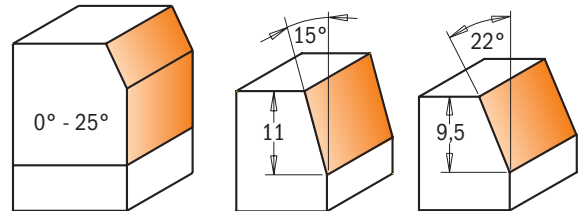

A	D mm	I mm	L mm	Z		ORDER NO. S=Ø6mm	ORDER NO. S=Ø6,35mm	ORDER NO. S=Ø8mm
0° - 25°	19 - 24,5	16 (10+6)	56,5	2	10	707.210.11		907.210.11
15°	18,6	11	57	2	10	709.016.11	809.016.11	
22°	12,7	7,8	47,6	2	10		809.022.11	
22°	17,5	9,5	51	3	10		809.023.11	
25°	19,05	10	52,4	2	10		809.025.11	
30°	27	9	55	2	10	709.260.11		909.260.11
45°	27	5,5	51,5	2	10	710.260.11		910.260.11

Spare parts

	791.007.00	990.004.00	991.062.00
990.422.00	791.044.00	990.058.00	991.057.00
	791.035.00	990.062.00	991.060.00
990.422.00	791.002.00	990.058.00	991.057.00
990.422.00	791.002.00	990.058.00	991.057.00
990.423.00	791.018.00	990.058.00	991.057.00
990.423.00	791.018.00	990.058.00	991.057.00

Flush Trim Bits

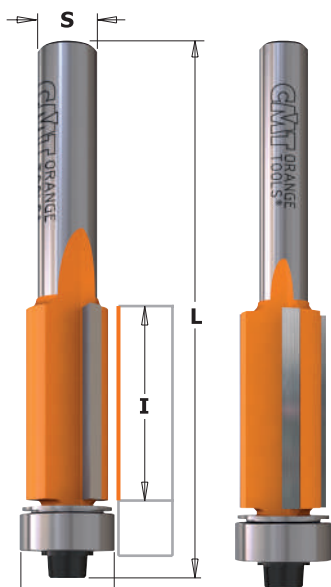

7/8/906

These truly indispensable bits were designed in a wide range of sizes for your woodworking needs as well as your most difficult projects. For precision work on laminates or quick template work with excellent finishing.

SHOP TIPS: these bits are excellent for making clean through-mortises. Use a straight bit Ø13mm (711.130.11) to produce a 5mm groove in the area you want to produce the through-mortise. With a drill bit Ø13mm (517.130.31) bore a hole through the wood at one end of the groove. Turn the workpiece over to finish the mortise. Use a flush trim bit Ø12mm with a cutting length slightly longer than the fillet, following the groove made on the opposite side of the workpiece with the ball bearing guide.

SAFETY TIPS: dust and chips from laminate materials are hazardous to your health and safety. Always wear a dust mask and eye protection when routing.

8/906.227.11
○ Z3

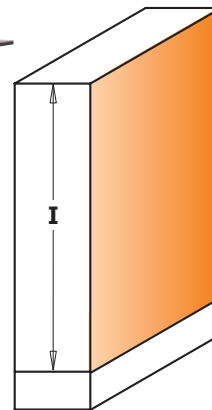

Drawing is 1:1 scale



* **WARNING!** Long cutting edges! Carefully make several shallow passes to prevent damaging the tool. The CMT warranty does not cover improper use of the tool.

BULK PACK 10 PCS.

• **HWM**

I mm	D mm	L mm	α		ORDER NO. S=Ø6mm	ORDER NO. S=Ø6,35mm	ORDER NO. S=Ø8mm	ORDER NO. S=Ø12mm	ORDER NO. S=Ø12,7mm
•25,4	6,35	63,5	0°	10	706.064.11	806.064.11			
12,7	9,5	55,5	0°	10	706.096.11	806.096.11	906.096.11		
12,7	12,7	57,8	-5°	10	706.128.11	806.128.11	906.128.11		
12,7	12,7	70,6	-5°	10				906.628.11	806.628.11
16	19	57,1	-5°	10	706.190.11		906.190.11		
25,4	9,5	68,2	0°	10	706.095.11	806.095.11	906.095.11		
25,4	12,7	70,7	-3°	10	706.127.11	806.127.11	906.127.11		
25,4	12,7	71	0°	10		806.227.11	906.227.11		
25,4	12,7	86,6	-3°	10				906.627.11	806.627.11
25,4	19	74,5	-5°	10	706.191.11	806.191.11	906.191.11		
25,4	19	87	-5°	10				906.691.11	806.691.11
38,1	12,7	94	0°	10				906.629.11	806.629.11
38,1	19	93,5	-3°	10				906.692.11	806.692.11
40	12,7	84	0°	10			906.129.11		
50,8	12,7	104	0°	10				906.630.11	806.630.11
50,8	19	110	-3°	10				906.690.11	806.690.11
*70	19	119	-3°	10				906.693.11	
BULK PACK 10 PCS.									
25,4	9,5	68,2	0°			806.095.11-X10			
25,4	12,7	70,7	-3°			806.127.11-X10			806.627.11-X10

Spare parts

	791.035.00	541.009.00	990.113.00
990.422.00	791.002.00		990.058.00
990.423.00	791.003.00		990.058.00
990.423.00	791.003.00		990.058.00
	791.007.00		990.004.00
990.422.00	791.002.00		990.058.00
990.423.00	791.003.00		990.058.00
990.423.00	791.003.00		990.058.00
990.423.00	791.003.00		990.058.00
990.425.00	791.004.00	541.550.00	990.058.00
990.425.00	791.004.00	541.550.00	990.058.00
990.423.00	791.003.00		990.058.00
990.425.00	791.004.00	541.550.00	990.058.00
990.423.00	791.003.00		990.058.00
990.423.00	791.003.00		990.058.00
990.425.00	791.004.00	541.550.00	990.058.00
990.425.00	791.004.00	541.550.00	990.058.00

Spare parts: 991.055.00 0,9mm hex key for screw M2 (990.113.00)
 991.057.00 3/32" hex key for screw (990.058.00)
 991.062.00 2,5mm hex key for screw (990.004.00)

SHOP TIPS: after resharpening, replace bearing as follow:
 791.002.00 (Ø9,5mm) with undersized bearing 791.062.00 (Ø9,3mm)
 791.003.00 (Ø12,7mm) with undersized bearing 791.063.00 (Ø12,5mm)

Flush Trim Bit Set



806

Indispensable in any shop, the new 3 piece flush trim bit set gives you the option to trim laminates or do template work conveniently using just one instrument.

- Set contains:
 806.095.11 (Ø9,5x25,4mm)
 806.096.11 (Ø9,5x12,7mm)
 806.191.11 (Ø19x25,4mm)

DESCRIPTION		ORDER NO. S=Ø6,35mm
Flush Trim Bit Set	5	806.001.11



Super-duty Flush Trim Bit - XTREME Series

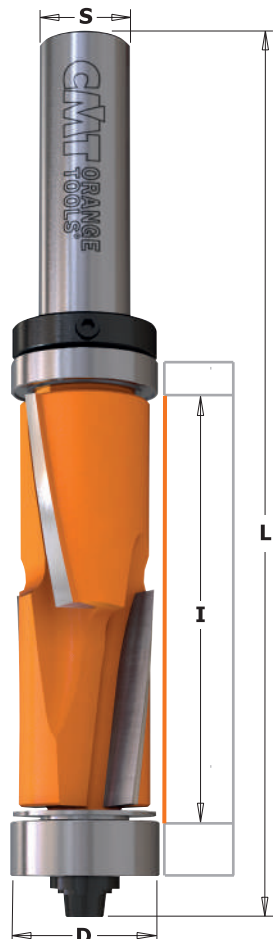

8/906B XTREME



These new **XTREME** flush trim bits guarantee the best possible finish along with extra-long life thanks to one-of-a-kind spiral technology. 4 cutting edges in high quality carbide are crafted using special brazing techniques as well as unique positive and negative design thus eliminating splintering on the upper and lower sides of the material you're working with. Ideal for projects involving precious wood, melamine and delicate engineered veneers.

NOTA: use of variable speed routing machines is required.
19mm bits Max RPM 18.000
35mm bits Max RPM 16.000

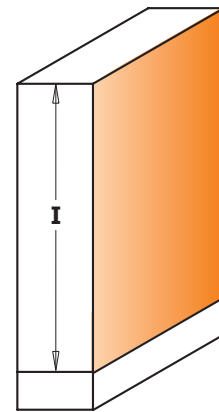
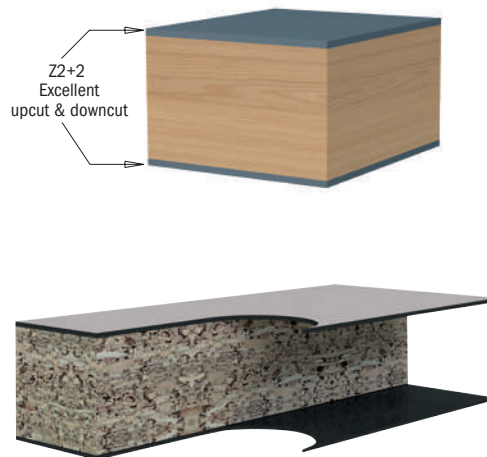

Drawing is 1:1 scale

I mm	D mm	L mm		ORDER NO. S=Ø6mm	ORDER NO. S=Ø6,35mm	ORDER NO. S=Ø8mm
25,4	12,7	80	10	706.127.41B		
25,4	12,7	80	10		806.127.41B	
25,4	19	86	10		806.191.41B	
25,4	19	86	10			906.191.41B

Spare parts

990.423.00	791.003.00		990.058.00	791.010.00	541.003.00
990.423.00	791.003.00		990.058.00	791.010.00	541.001.00
990.425.00	791.004.00	541.550.00	990.058.00	791.004.00	541.001.00
990.425.00	791.004.00	541.550.00	990.058.00	791.034.00	541.004.00

I mm	D mm	L mm		ORDER NO. S=Ø12mm	ORDER NO. S=Ø12,7mm
50,8	19,05	113	10	906.690.41B	806.690.41B
50,8	34,9	123	10	906.880.41B	806.880.41B

Spare parts

990.425.00	791.004.00	541.550.00	990.058.00	791.011.00	541.002.00
990.426.00	791.029.00	541.552.00	990.058.00	791.029.00	541.002.00

Spare parts: **991.056.00** 1,5mm hex key for screw (M3)
991.057.00 3/32" hex key for screw (990.058.00)

DP - Flush Trim Bits for Laminates - LONG LIFE

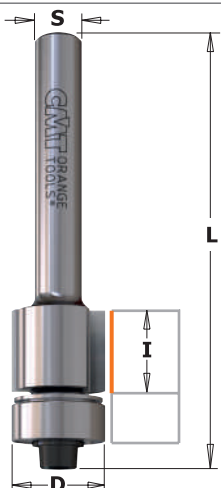

7/8/906 XTREME



These new super duty DP (polycrystalline diamond) bits represent the ultimate in the extensive line of CMT flush trim bits. Investing in CMT DP flush trim bits means saving time and money, as they last 40 times longer than conventional carbide-tipped flush trim bits.

SHOP TIPS: after resharpener, replace bearing 791.003.11 (Ø12,7mm) with undersized bearing **791.063.00** (Ø12,5mm)

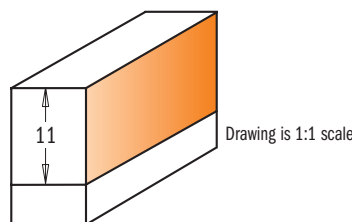

Drawing is 1:1 scale



I mm	D mm	L mm		ORDER NO. S=Ø6mm	ORDER NO. S=Ø6,35mm	ORDER NO. S=Ø8mm
11	12,7	58,1	10	706.128.61	806.128.61	906.128.61

Spare parts

990.423.00	791.003.00	990.058.00	991.057.00

Double-Bearing Spiral Flush Trim Bits

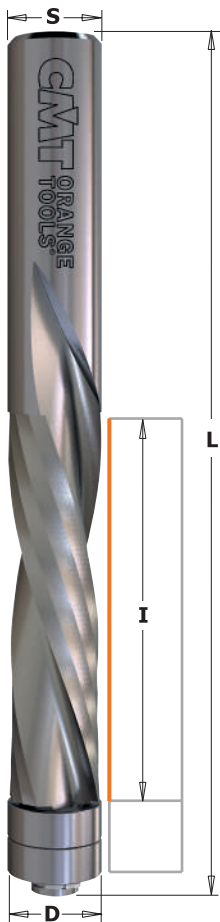

190B - 191B - 192B

CMT solid carbide spiral flush trim bits are composed of a special super-micrograin formulation increasing hardness with a higher transverse rupture point. Combined with a spiral cutting angle, CMT solid carbide spiral flush trim bits equipped with a double bearing, allow cabinet makers to shear wood and wood products cleanly, providing more efficient chip ejection than standard flush trim bits. In production settings, this means these bits will run cooler, stay sharper, last longer and increase shop productivity.

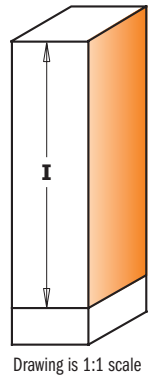
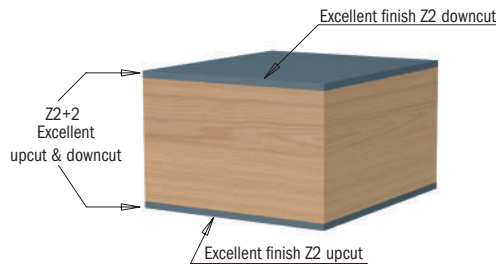

Drawing is 1:1 scale

I mm	D mm	L mm		ORDER NO. S=Ø6mm	ORDER NO. S=Ø6,35mm	ORDER NO. S=Ø12mm	ORDER NO. S=Ø12,7mm	Spare parts		
Z2+2 UPCUT & DOWNCUT										
47,6	12,7	114	10			190.127.11B	190.508.11B	791.010.00		541.301.00
Z2 UPCUT										
25,4	6,35	76,2	10	191.064.11B	191.008.11B			791.035.00	541.009.00	
31,7	12,7	89	10				191.505.11B	791.010.00		541.301.00
50,8	12,7	114	10			191.127.11B	191.507.11B	791.010.00		541.301.00
Z2 DOWNCUT										
25,4	6,35	76,2	10		192.008.11B			791.035.00	541.009.00	
31,7	12,7	89	10				192.505.11B	791.010.00		541.301.00
50,8	12,7	114	10			192.127.11B	192.507.11B	791.010.00		541.301.00

3-in-1 Flush Trim Bits for MDF/Laminate

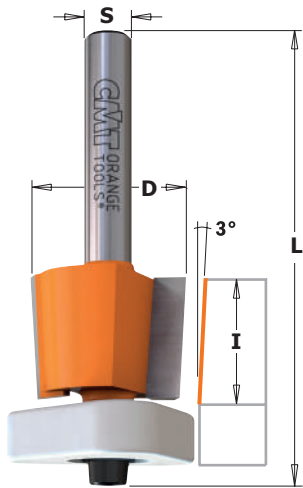

7/8/907

3 in 1 new flush trim bits with DELRIN® Triangular bearings are your best partner for laminate trimming. In fact, it solves three of the most common problems that occur when flush trimming:

- 1) The anti-stick properties of the DELRIN® bearing greatly reduces the likelihood of freezing of the bearing from glue.
- 2) The extended guide surface of the new DELRIN® bearing will perfectly match the work surface without scratching like a steel bearing would. The DELRIN® bearing also guarantees maximum stability.
- 3) The shear angle cutting edge reduces the need for filing. 3-in-1 bits are ideal on plastic laminates as well as aluminium laminates!

3-in-1 bits are ideal on plastic laminates as well as aluminium laminates!

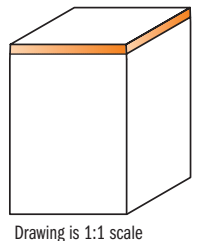

Drawing is 1:1 scale



Patent No. D628,218

- Extended guide surface
- Non-freezing
- Non-scratch surface



PERFECT TRIMMING WITH CONICAL EDGES!

Thanks to the innovative conical edges of this bit, you will always get perfect cuts even after re-sharpening. In fact, the most common problem you have with standard flush trim bits is the undersized diameter after re-sharpening which leaves a mark on the material; with the new CMT construction you could re-sharpen up to six times without any problem. Just remember to adjust your bit up or down as per the illustration.

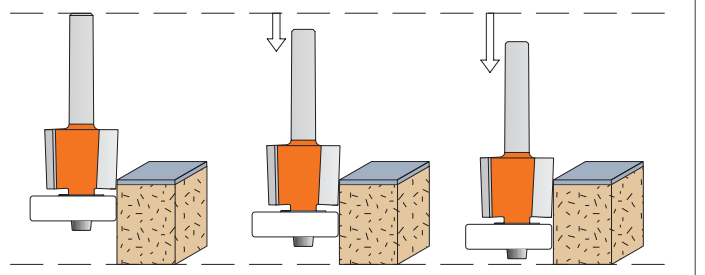

I mm	D mm	L mm		ORDER NO. S=Ø6mm	ORDER NO. S=Ø6,35mm	ORDER NO. S=Ø8mm	ORDER NO. S=Ø12,7mm	Spare parts			
12,7	12,7	54,2	10	707.128.11	807.128.11	907.128.11					
15,87	19	59,3	10	707.190.11	807.190.11	907.190.11		990.422.00	791.042.00	990.058.00	991.057.00
15,87	19	65,7	10				807.690.11	990.423.00	791.043.00	990.058.00	991.057.00
								990.423.00	791.043.00	990.058.00	991.057.00



657.9

Specially designed to perform difficult trimming operations, these bits are both indispensable and economical. Flush trim bits with two replaceable knives fixed by special TORX® screws. The 2-sided blades can create extra new edges. Guided flush trim bits type **657.1** are equipped with ball bearing guides.



SAFETY TIPS



The **TW-006** Torque Screwdriver is recommended for the proper fastening of screws (see page 413).

CORRECT KNIFE POSITIONING

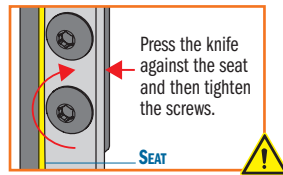

Press the knife against the seat and then tighten the screws.

SEAT

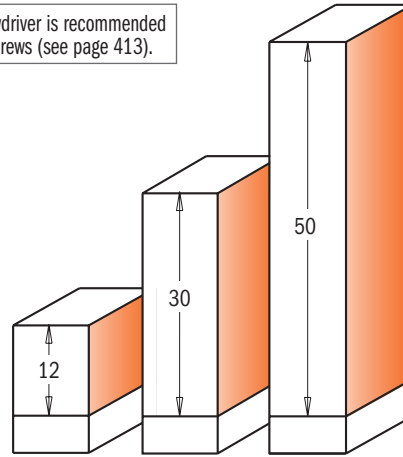

Drawing is 1:1 scale

657.1



I mm	D mm	L mm		ORDER NO. S=Ø6mm	ORDER NO. S=Ø6,35mm	ORDER NO. S=Ø8mm	ORDER NO. S=Ø12mm	ORDER NO. S=Ø12,7mm
12	19	57	10	657.194.11	657.192.11	657.190.11		
30	16	75	10			657.161.11		
30	19	76	10	657.195.11				
30	19	77	10			657.191.11		
30	19	87	10					657.692.11
50	19	112	10				657.991.11	657.992.11

Spare parts

790.120.00	990.075.00	991.061.00	791.007.00
790.295.09	990.115.00	991.061.00	791.006.00
790.300.00	990.075.00	991.061.00	791.007.00
790.300.00	990.075.00	991.061.00	791.007.00
790.300.00	990.075.00	991.061.00	791.007.00
790.500.00	990.075.00	991.061.00	791.007.00

Spare parts: **990.400.00** Ø3.2/Ø7mm shield for M3 screw
990.410.00 Ø4.2/Ø9mm shield for M4 screws
990.051.00 M3x6mm TCEI screws

990.052.00 M4x6mm TCEI screws
991.067.00 3mm hex key
541.514.00 Ø6,4mm shield

FILE-FREE Flush Trim Bits for Laminate

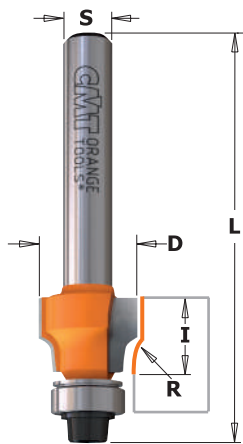

8/907



This bit is perfect for ensuring smooth flawless results on your laminate surfaces after flush trimming. Sharp edges are easily trimmed away, leaving your surfaces nice and smooth to the touch. No further filing is needed!

SHOP TIPS: after resharpening, replace bearing 791.002.00 (Ø9,5mm) with undersized bearing **791.062.00** (Ø9,3mm)

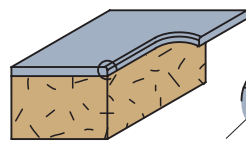

Drawing is 1:1 scale

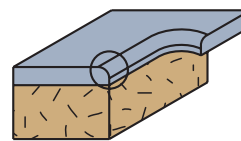

R 1,6

D mm	I mm	R mm	L mm		ORDER NO. S=Ø6,35mm	ORDER NO. S=Ø8mm
12,7	9,5	0,4	52	10	807.004.11	907.004.11
12,7	9,5	1,6	52	10	807.015.11	907.015.11

Spare parts

990.422.00	791.002.00	990.058.00	991.057.00
990.422.00	791.002.00	990.058.00	991.057.00

Pattern/Flush Trim Bits with Insert Knives



657B

These bits complete the wide range of CMT Flush Trim bits equipped with a bearing. A larger 19mm diameter and double bearing distinguishes this bit from the others given its increased stability throughout flush and trimming operations. This means completing difficult projects safely, especially when you require a significant amount of swarf removal and an optimal precision finish.



CORRECT KNIFE POSITIONING

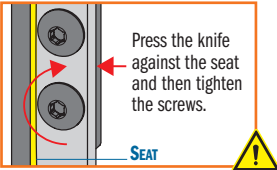

SAFETY TIPS



The **TW-006** Torque Screwdriver is recommended for the proper fastening of screws (see page 413).

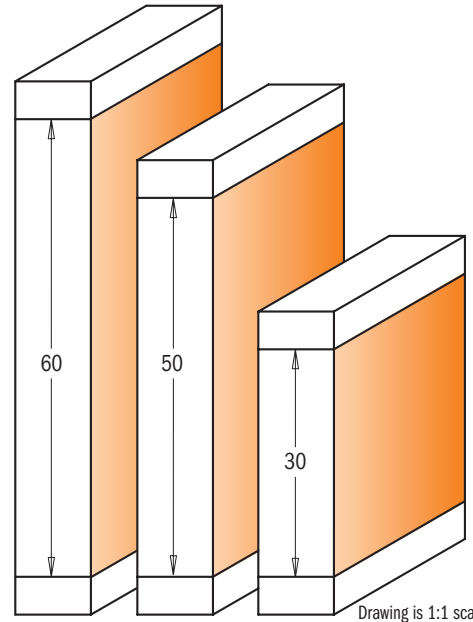

Drawing is 1:1 scale

I mm	D mm	L mm		ORDER NO. S=Ø8mm	ORDER NO. S=Ø12mm	ORDER NO. S=Ø12,7mm
30	19	90	10	657.191.11B		657.692.11B
30	19	90	10			657.692.11B
50	19	110	10		657.993.11B	657.994.11B
60	19	120	10		657.995.11B	657.996.11B

Spare parts

790.300.00	990.075.00	791.007.00	990.052.00	791.034.00	541.004.00
790.300.00	990.075.00	791.007.00	990.052.00	791.011.00	541.002.00
790.500.00	990.075.00	791.007.00	990.052.00	791.011.00	541.002.00
790.600.00	990.075.00	791.007.00	990.052.00	791.011.00	541.002.00

Spare parts: **990.410.00** Ø4,2/Ø9mm shield for M4 screws
991.067.00 3mm hex key

991.061.00 T15 TORX® key
991.056.00 1,5mm hex key

Flush Trim Router Bits with Double Bearing

806/906B



The innovative two-flute router bits are equipped with a double bearing and feature a down shear design allowing cleaner, smoother cuts on a variety of materials.

Now its no longer necessary to flip or move your tool during routing operations. This tool is particularly effective when routing curved elements along or against the grain.

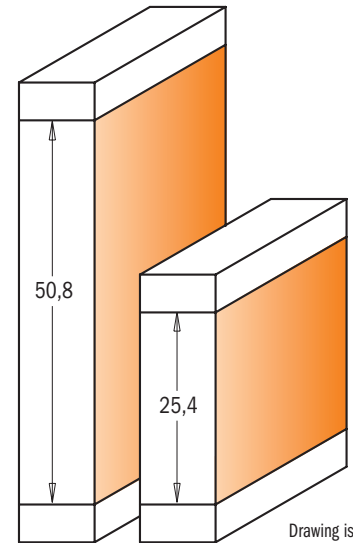

Drawing is 1:1 scale

I mm	D mm	L mm	α		ORDER NO. S=Ø12mm	ORDER NO. S=Ø12,7mm
25,4	19	86,5	-5°	10	906.691.11B	
25,4	19	86,5	-5°	10		806.691.11B
50,8	19	109,5	-3°	10	906.690.11B	
50,8	19	109,5	-3°	10		806.690.11B

Spare parts

990.425.00	791.004.00	541.550.00	990.058.00	791.011.00	541.005.00
990.425.00	791.004.00	541.550.00	990.058.00	791.011.00	541.002.00
990.425.00	791.004.00	541.550.00	990.058.00	791.011.00	541.005.00
990.425.00	791.004.00	541.550.00	990.058.00	791.011.00	541.002.00

Spare parts: **991.057.00** 3/32" hex key

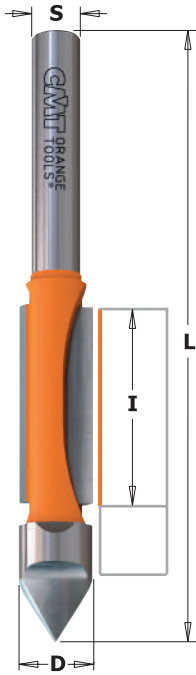

7/8/916

How much time do you end up spending making openings in paneling, drywall, siding, doors or windows? With the CMT panel pilot bit, the job just got quicker. The point of this bit as well as the **716.061**, plunge smoothly and easily and the carbide edges cut clean and fast. All of this adds up to accurate cuts in less time and with less effort - great for trimming veneer as well as a variety of laminates.

SAFETY TIPS: always use extra caution when working near electrical outlets and boxes - always shut off the power. Make sure the bit does not go so deep as to touch or cut the wires.

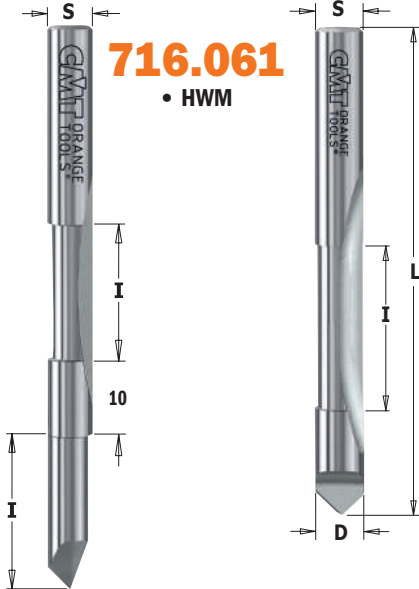

716.061
• HWM

716.060
816.064
• HWM



D mm	I mm	L mm	Z		ORDER NO. S=Ø6mm	ORDER NO. S=Ø6,35mm	ORDER NO. S=Ø8mm	ORDER NO. S=Ø12mm	ORDER NO. S=Ø12,7mm
•6	19	60	1	10	716.060.11				
•6	18+18	70	1+1	10	716.061.11				
•6,35	19	64	1	10		816.064.11			
8	19	64	1	10			916.080.11		
9,53	25,4	78	2	10		816.095.11			
12	31,7	102	2	10				916.627.11	
12,7	31,7	102	2	10					816.627.11
BULK PACK 10 PCS.									
•6,35	19	64	1			816.064.11-X10			
12,7	31,7	102	2						816.627.11-X10

• HWM

Panel Pilot Bits with Guide

7/8/953



An absolutely indispensable bit for making cabinets. CMT Flush and V-Groove bits allow you to make cabinet front frames in 25mm stock that fit perfectly with the sides. The added V-cutter feature makes a decorative groove along the hinge joint to hide the seam.

SHOP TIPS: For best results, leave less than 3mm overhang on cabinet front frames for easier routing.

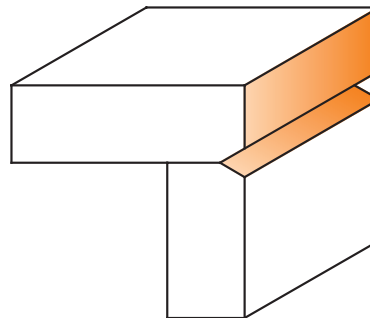
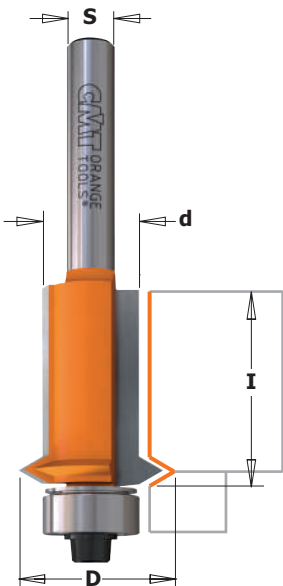

Drawing is 1:1 scale

d mm	D mm	I mm		ORDER NO. S=Ø6mm	ORDER NO. S=Ø6,35mm	ORDER NO. S=Ø8mm	ORDER NO. S=Ø12mm	ORDER NO. S=Ø12,7mm	Spare parts							
12,7	19	25,4	10	753.001.11	853.001.11	953.001.11	953.501.11	853.501.11					990.423.00	791.003.00	990.058.00	991.057.00

The CMT Grand Rabbet Set



8/935.503

"The Grand Rabbet" by CMT is an investment that shows your commitment to quality. This CMT product will deliver years of reliable service under normal use. For safe and trouble-free results please observe the following instructions and safety precautions. The complete kit (item code **835-935.503.11**), will enable you to produce 17 different rabbet sizes including rabbets for under-sized plywood applications. For rabbet sizes over 12,7mm (1/2"), make the cuts in several shallow passes until the desired depth is achieved.

Available in 12mm and 12,7mm shanks.

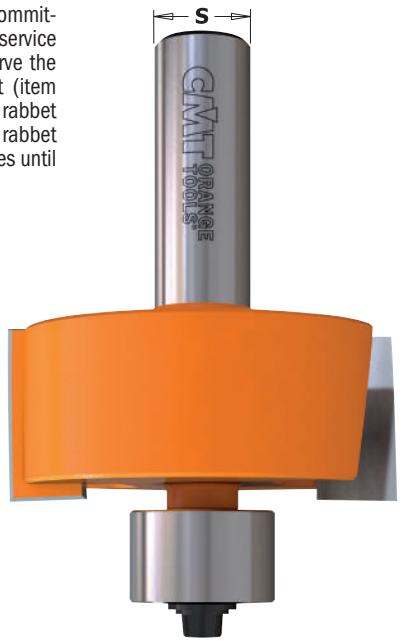

8/935.990



Collar order no.
799.517.00

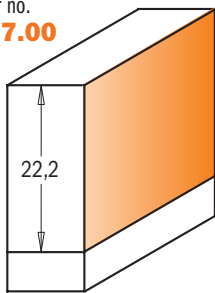

Order no. **791.705.00**

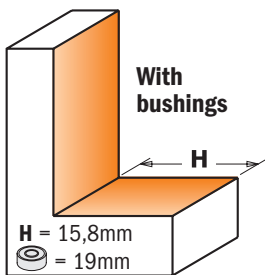
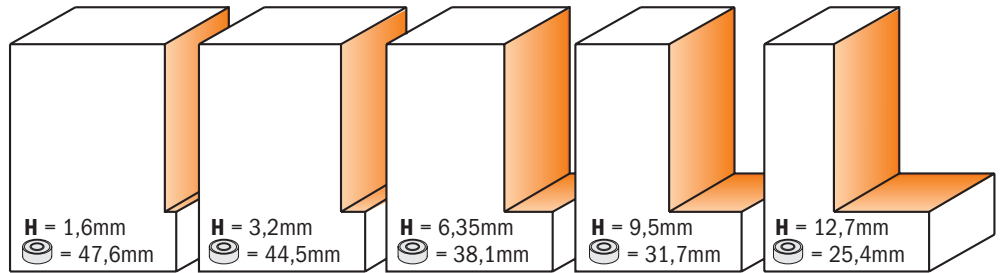

Order no. **791.706.00**

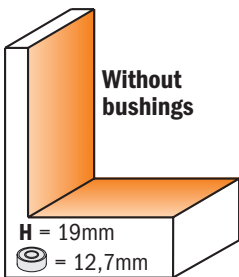
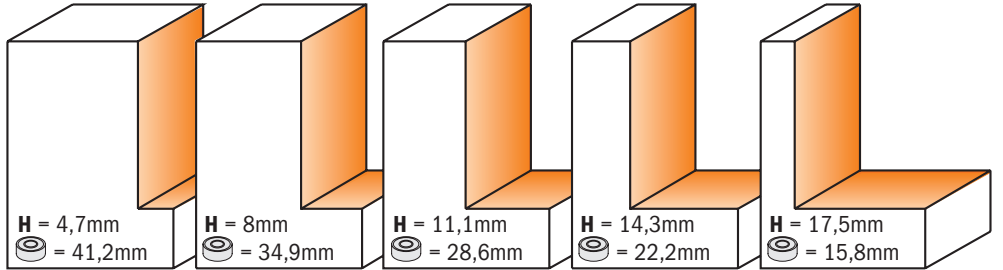

Order no. **791.707.00**

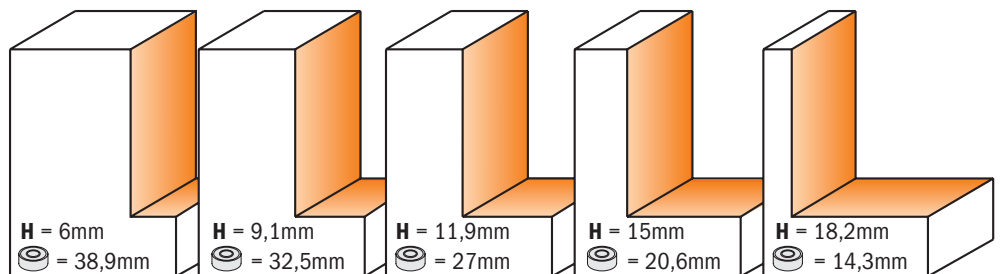

Drawing is 1:1 scale

DESCRIPTION	Box Icon	ORDER NO. S=Ø12mm	ORDER NO. S=Ø12,7mm
The CMT Grand Rabbet Set (Ø50,8x22,2mm)	1	935.503.11	835.503.11

Set contains: The Grand Rabbet (bit only) with bushing Ø19mm
 5 pcs. Bushing kits for bearing (H=1,6 - 3,2 - 6,35 - 9,5 - 12,7mm rabbets)
 5 pcs. Bushing kits for bearing (H=4,7 - 8 - 11,1 - 14,3 - 17,5mm rabbets)
 5 pcs. Bushing kits for bearing (H=6 - 9,1 - 11,9 - 15 - 18,2mm rabbets)
 Bushing Ø50,8mm
 Kit with screw, shields and keys

935.990.11 **835.990.11**
791.705.00
791.706.00
791.707.00
799.517.00
990.452.00

Grand Rabbeting Bits with Insert Knives



660.9



"The Grand Rabbet" by CMT is an investment that shows your commitment to quality. This CMT product will enable you to produce 17 different rabbet sizes including rabbets for under-sized plywood applications. For rabbet sizes over 12,7mm (1/2"), make the cuts in several shallow passes until the desired depth is achieved. Available in 12mm and 12,7mm shanks.

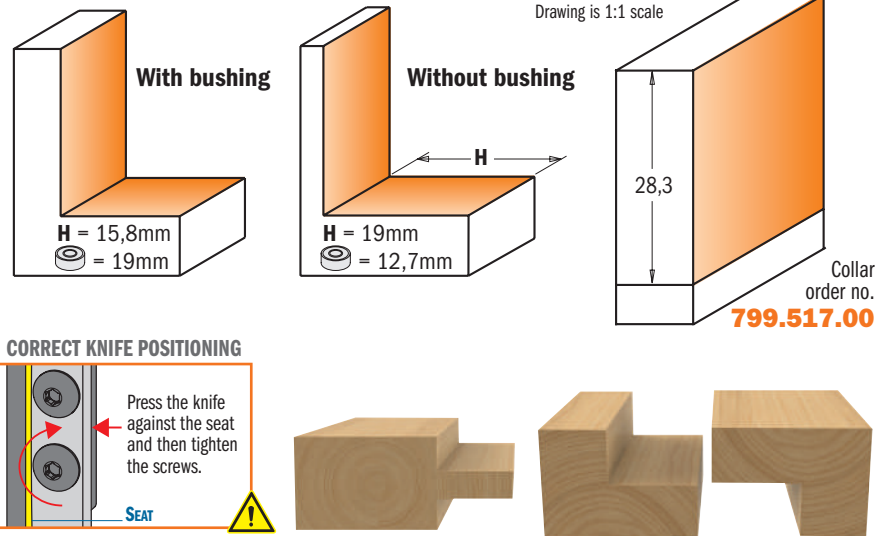

SAFETY TIPS

The **TW-006** Torque Screwdriver is recommended for the proper fastening of screws (see page 413).

H mm	D mm	I mm	L mm		ORDER NO. S=Ø12mm	ORDER NO. S=Ø12,7mm	Spare parts							
16	50,8	28,3	86	10	660.990.11	660.991.11					790.283.12	990.075.00	991.061.00	791.010.00

- Spare parts:** 541.514.00 Ø6,4mm stop collar
 799.503.00 Ø19,05mm bushings
 990.410.00 Ø4.2/Ø9mm shield for M4 screw
 990.052.00 M4x6mm TCEI screw
 991.067.00 3mm hex key
 990.469.00 Kit screw, shield and key
- Optional:** 799.517.00 Bushing for flush trim Ø50,8mm
 791.705.00 5 pcs. bushing set (H=1,6-3,2-6,35-9,5-12,7mm rabbets)
 791.706.00 5 pcs. bushing set (H=4,7-8-11,1-14,3-17,5mm rabbets)
 791.707.00 5 pcs. bushing set (H=6-9,1-11,9-15-18,2mm rabbets)

Rabbeting Bits

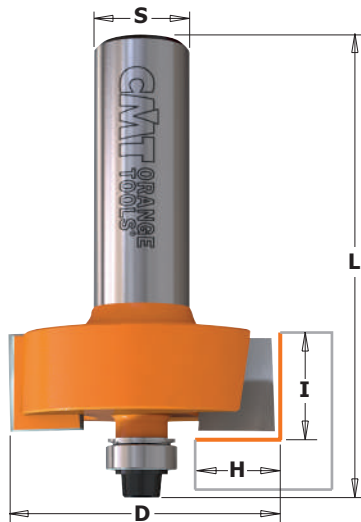

7/8/935



CMT carbide-faced rabbeting bits are fast and accurate - you can quickly produce inset doors and drawer fronts, make strong rabbet joints, mill perfect tongue and groove joints or any number of other jobs usually time consuming and difficult. Other possibilities for these tungsten carbide bits are illustrated below and on the following pages.

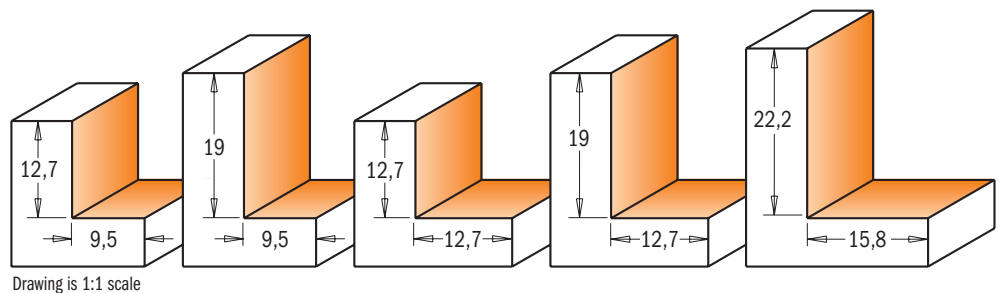

H mm	D mm	I mm	L mm		ORDER NO. S=Ø6mm	ORDER NO. S=Ø6,35mm	ORDER NO. S=Ø8mm	ORDER NO. S=Ø12mm	ORDER NO. S=Ø12,7mm	Spare parts					
9,5	31,7	12,7	58,4	10	735.317.11	835.317.11	935.317.11						990.423.00	791.003.00	990.058.00
9,5	31,7	12,7	61,2	10				935.817.11	835.817.11				990.423.00	791.003.00	990.058.00
9,5	31,7	19	64,8	10	735.318.11		935.318.11						990.423.00	791.003.00	990.058.00
12,7	34,9	12,7	59,4	10	735.350.11	835.350.11	935.350.11	935.850.11	835.850.11				990.422.00	791.002.00	990.058.00
12,7	34,9	19	65,8	10				935.851.11	835.851.11				990.422.00	791.002.00	990.058.00
15,8	50,8	22,2	77,8	10				935.990.11	835.990.11				990.408.00	791.010.00	990.058.00

- Spare parts:** 541.514.00 2mm spacer (8/935.990.11)
 799.503.00 19,05mm bushings
 991.057.00 3/32" hex key

Rabbeting Bits with Insert Knives

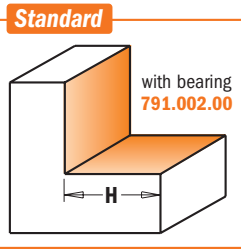

Drawing is 1:1 scale

CORRECT KNIFE POSITIONING

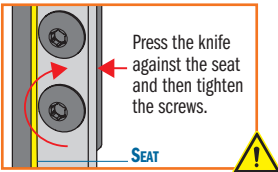

660

INSERT CARBIDE **Z2 Z4 RH** **4X CUTTING**

Rabbeting bits for creating cabinet doors, backsides and drawer fronts. Every bit is equipped with a standard bearing (791.002.00), but other bearings are also available in order to craft a variety of rabbeting widths. For use on chipboard, wood or MDF.

SAFETY TIPS

The **TW-006** Torque Screwdriver is recommended for the proper fastening of screws (see page 413).

791.703.00 Optional



With this kit **791.703.00** you can carry out all cutting depths below.

Drawing is 1:1 scale

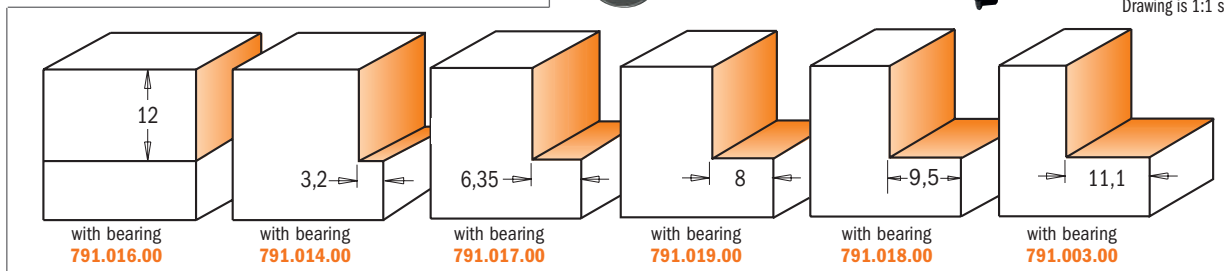

H mm	D mm	Z	I mm	L mm	Box	ORDER NO. S=Ø6,35mm	ORDER NO. S=Ø8mm	ORDER NO. S=Ø12mm	ORDER NO. S=Ø12,7mm
12,7	34,9	2	12	55	10	660.351.11	660.350.11		660.851.11
12,7	34,9	2	12	65	10				
22,2	57	4	12	66	5			660.570.11	

Spare parts

Part	Part	Part
790.120.00	990.422.00	791.002.00
790.120.00	990.422.00	791.002.00
790.120.03	990.423.00	791.003.00

Spare parts: **990.075.00** M4x6mm TORX® screw **991.061.00** T15 TORX® key **990.058.00** 1/8"x3/8"x1/2" TCEI screw **991.057.00** 3/32" hex key

Rabbeting Sets

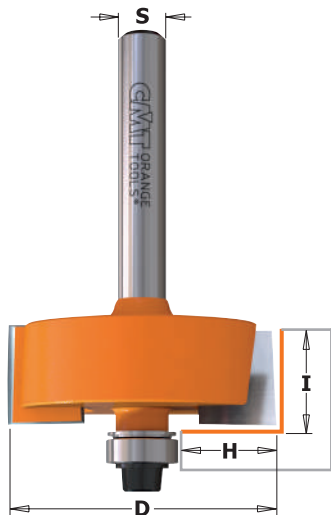

7/8/935.001_501

HW **Z2 RH**

CMT rabbeting sets include one rabbeting bit, 6 interchangeable ball bearing guides, fastening screws, shields and an hex key. In order to change cutting depth, substitute the bearing.

791.703.00 Standard



BE SURE to keep the black bearing washer right side up to correspond with the bearing rotation when re-assembling the bearing. Improper re-assembly can cause the screw to come loose.

Drawing is 1:1 scale

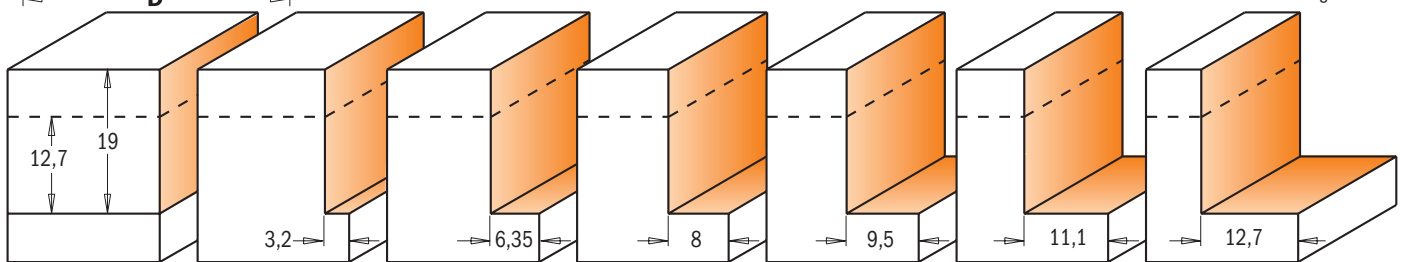

H mm	D mm	I mm	Box	ORDER NO. S=Ø6mm	ORDER NO. S=Ø6,35mm	ORDER NO. S=Ø8mm	ORDER NO. S=Ø12mm	ORDER NO. S=Ø12,7mm
0-12,7	34,9	12,7	5	735.001.11	835.001.11	935.001.11	935.501.11	835.501.11
0-12,7	34,9	19	5				935.502.11	835.502.11

Spare parts: **791.002.00** Ø4,76/Ø9,5mm bearing **990.058.00** 1/8"x3/8"x1/2" TCEI screw **990.422.00** Ø4,76/Ø9,5mm shield **991.057.00** 3/32" hex key

Keyhole Bits

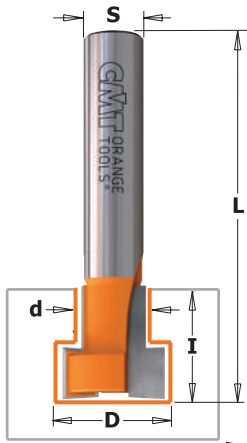

7/8/950.0_5

With the CMT keyhole bit you can make holes that keep your frames, plaques or any wall hanging perfectly straight and attached to the wall. The perfect way to securely mount wall hangings on screws and nails. Three new bits available to create slots for M5, M6, M8, M10, M12 hexagonal head bolt for removable joints.

SAFETY TIPS: Be sure the workpiece is securely fastened to the router table or work bench.

SHOP TIPS: Recommended for use with a plunge router.



850.501.21

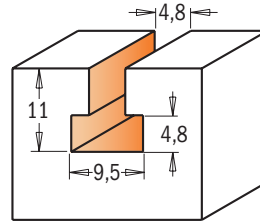

Drawing is 1:1 scale

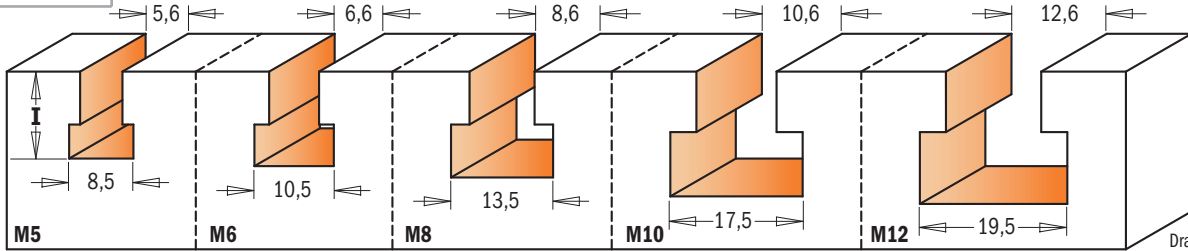
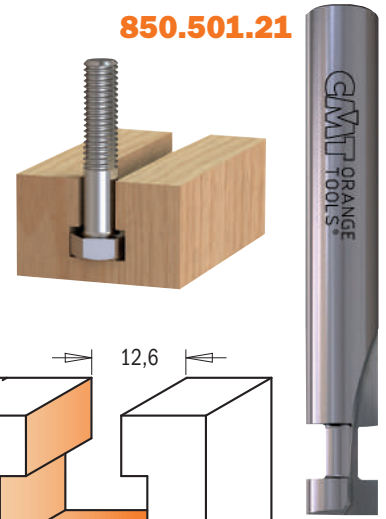

Drawing is 1:1 scale

D mm	d mm	I mm	L mm	Z		ORDER NO. S=Ø6mm	ORDER NO. S=Ø6,35mm	ORDER NO. S=Ø8mm	ORDER NO. S=Ø9,5mm	ORDER NO. S=Ø12mm	ORDER NO. S=Ø12,7mm
9,5	4,8	11	54	1		10	750.001.11	850.001.11	950.001.11	950.501.11	850.501.11
•9,5	4,76	11	65	2		10			850.501.21		
8,5	5,6	11,5	48	1	M5	10		950.002.11			
10,5	6,6	12,5	48	1	M6	10		950.003.11			
13,5	8,6	14	48	2	M8	10		950.004.11			
17,5	10,6	16,5	48	2	M10	10		950.005.11			
19,5	12,6	17,5	48	2	M12	10		950.006.11			

• HWM

T-Slot Bits

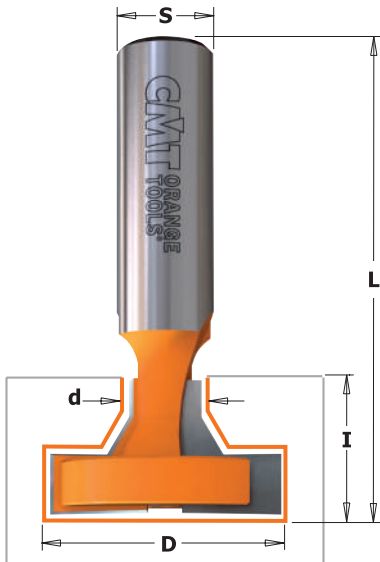

8/950.1_6

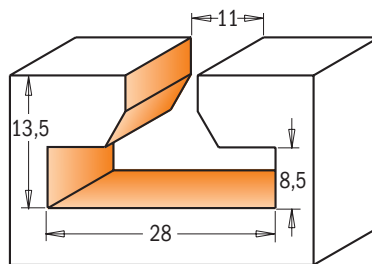

8/950.103 - 603

Drawing is 1:1 scale

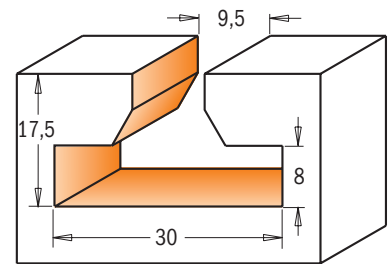

8/950.101 - 601

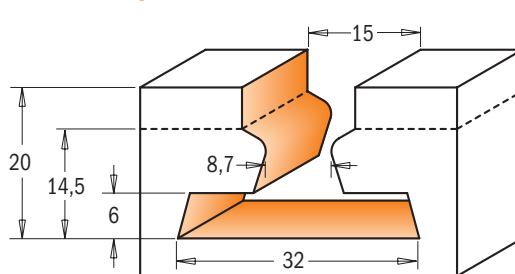

950.604

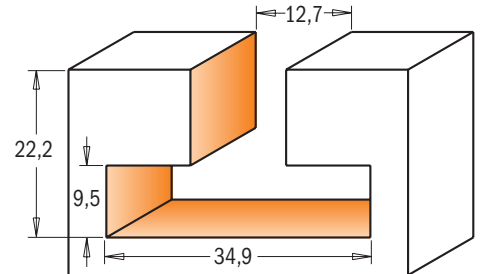

8/950.602

D mm	d mm	I mm	L mm	Z		ORDER NO. S=Ø8mm	ORDER NO. S=Ø12mm	ORDER NO. S=Ø12,7mm
28	11	13,5	47,6	2	10	950.103.11		
28	11	13,5	56,3	2	10		950.603.11	850.603.11
30	9,5	17,5	50,8	2	10	950.101.11		
30	9,5	17,5	60,3	2	10		950.601.11	850.601.11
32	8,7-15	20	66	1+1	10		950.604.11	
34,9	12,7	22,2	63,5	2	10		950.602.11	850.602.11

Screw Slot Bits

HW Z2 RH

8/913

Any large panel or table top should be secured in a way that allows it to expand or contract without splitting. These screw-slot bits let you create screw slots so that panels can be held in place but are able to slide back and forth without splitting the wood or breaking the screw securing them.

Bits available in 8 and 12,7mm shank; art. **913.201.11** and art. **813.701.11** correspond to countersink screws and art. **913.101.11** and art. **813.601.11** correspond to flat-head screws.

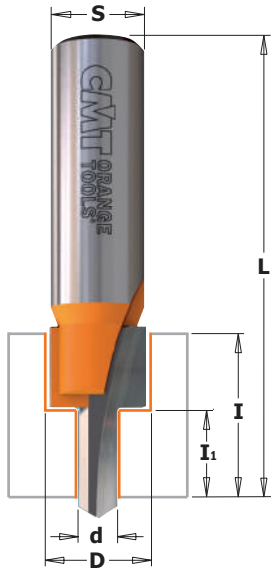

913.101.11
813.601.11

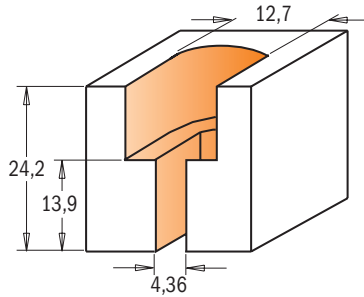

Drawing is 1:1 scale

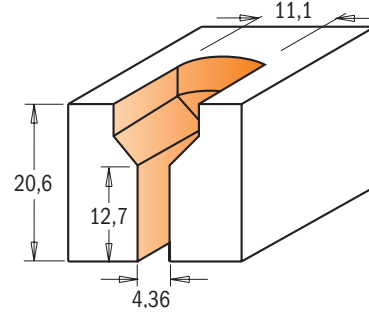

913.201.11
813.701.11

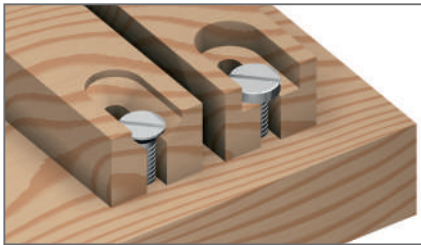

D mm	d mm	I ₁ mm	I mm	L mm		ORDER NO. S=Ø8mm	ORDER NO. S=Ø12,7mm
11,1	4,36	12,7	20,6	63,5	10	913.201.11	813.701.11
12,7	4,36	13,9	24,2	63,5	10	913.101.11	813.601.11

Flooring Router Bits

HW Z2 RH

822.023B - 822.024B

CMT now offers you these industrial quality carbide-tipped router bits for flooring and inlay applications. They easily and smoothly run through solid and timber wood while cutting edges and remain sharp even after several passes **822.024.11B** item number also features rounded edges to produce 3,2mm (1/8") radius inlays. These bits are equipped with a stop collar and a bearing.

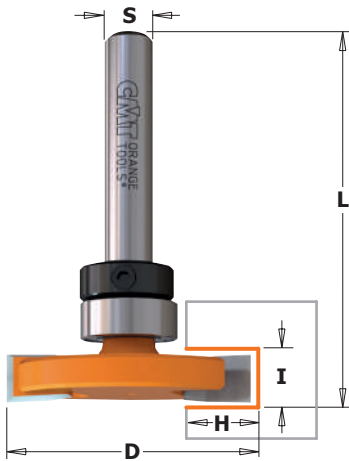

822.023.11B

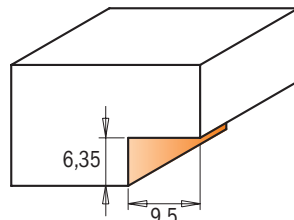
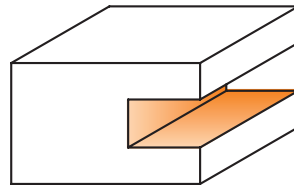

Drawing is 1:1 scale

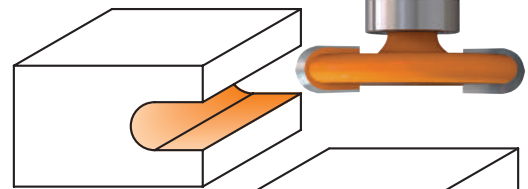

822.024.11B

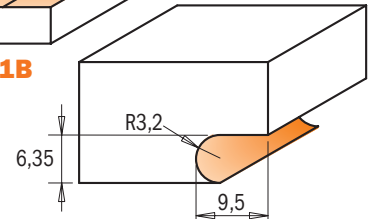

D mm	I mm	H mm	R mm	L mm		ORDER NO. S=Ø6,35mm
31,75	6,35	9,5		47,6	10	822.023.11B
31,75	6,35	9,5	3,2	47,6	10	822.024.11B

Spare parts

791.010.00	541.001.00	990.005.00	991.056.00
791.010.00	541.001.00	990.005.00	991.056.00

3-Wing Slot Cutter

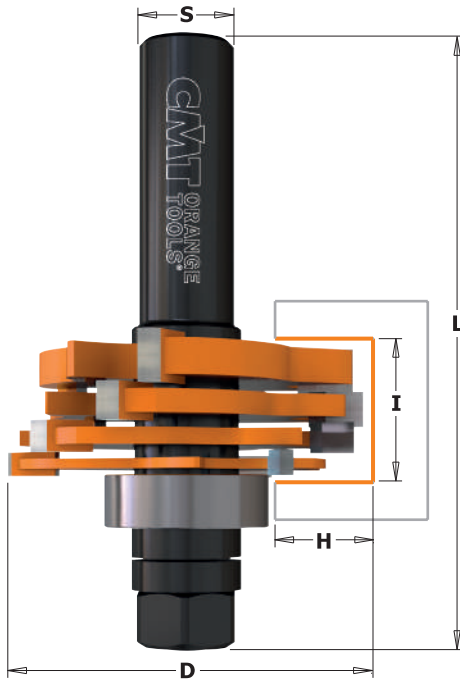

8/900.506

Create slots, grooves and rabbets in materials from 3,2mm to 18mm in depth by using the adjustable CMT 3-Wing slot cutter set. See chart below for details on spacing and correct cutter combinations. Ideal for biscuit joints and milling perfect tongue and groove joints. This set includes:

- 4 carbide tipped cutters 3,2mm, 4mm, 4,8mm, 6,4mm
- 1 arbor 12mm or 12,7mm
- 1 ball bearing (22mm) for 12,7mm cut
- 17 shims: (8x0,1mm - 4x0,5mm - 3x1mm and 2x4mm)

SAFETY TIPS: never use the slot cutter set without shims between the cutters. The distance between the cutters can vary from 1mm to 1,7mm. A shim must also be positioned between the ball bearing and the cutters.

SHOP TIPS: the bearings kit **791.711.00** makes 6,35mm and 9,5mm cutting depths.

NOTE: the carbide edges of the cutters must never touch; arrange the shims as illustrated below. Use only thicknesses provided in the set. Be sure all cutters are assembled in the correct rotational direction. Looking downwards on the arbor, the cutters will turn clockwise.

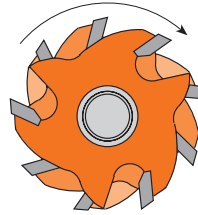

CUTTER COMBINATIONS	CUTTER HEIGHT	
	mm	mm
A	3,2	
B	4	
C	4,8	
D	6,4	
A + B	6,4	a 7,1
A + C	7,2	a 7,9
A + D	8,8	a 9,5
B + C	8	a 8,7
B + D	9,6	a 10,3
C + D	10,4	a 11,1
A + B + C	10,4	a 11,8
A + B + D	11,9	a 13,3
A + C + D	12,7	a 14,1
B + C + D	13,5	a 14,9
A + B + C + D	15,9	a 18

Use shims to adjust cut width: MIN 1,1mm - MAX 1,7mm

I mm	D mm	H mm	L mm		ORDER NO. S=Ø12mm	ORDER NO. S=Ø12,7mm
3,2-18	47,6	12,8	81	10	900.506.11	
3,2-18	47,6	12,8	81	10		800.506.11

Spare parts: **541.515.00** 0,1mm spacer
541.517.00 0,5mm spacer
541.518.00 1mm spacer
541.501.00 4mm spacer

Spare parts

924.128.00	791.005.00	990.020.00
824.128.00	791.005.00	990.020.00

Optional: 791.711.00 2 pcs bearing set for depth variations 28,5mm and 34,9mm

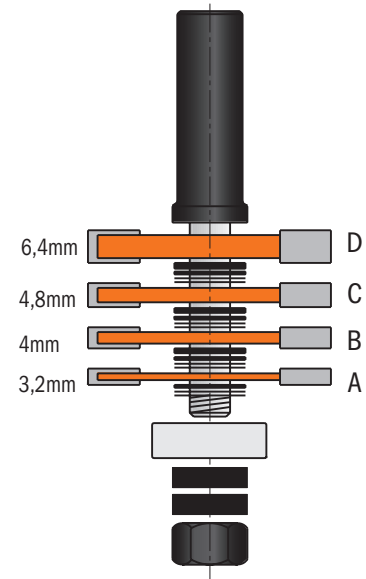

Tongue & Groove Set

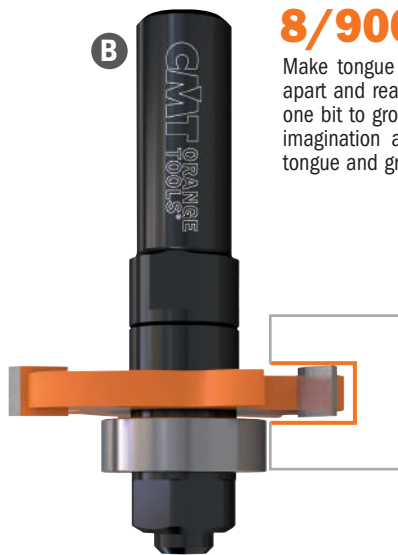
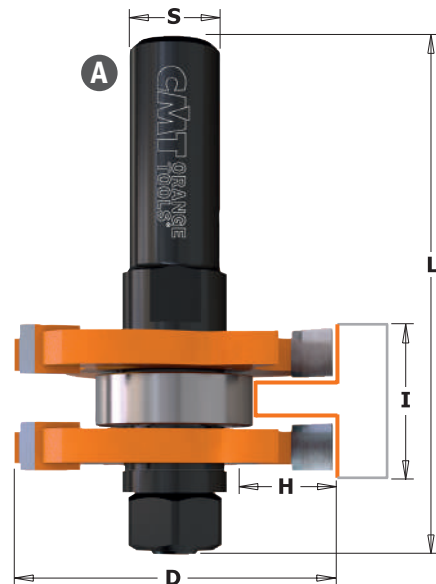

8/900.626



Make tongue and groove joints without the complicated process of taking apart and reassembling bits. The new CMT tongue and groove set gives you one bit to groove the slot and a separate bit to mill the tongue. Or use your imagination and put them to work individually on other projects. Makes tongue and groove cuts in wood up to 19mm thickness.

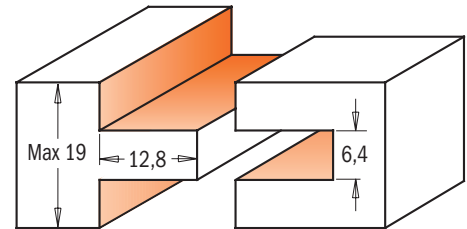

Drawing is 1:1 scale

PROFILE	I mm	D mm	H mm	L mm		ORDER NO. S=Ø8mm	ORDER NO. S=Ø12mm	ORDER NO. S=Ø12,7mm
A+B	19	47,6	12,8	71	5	900.126.11		
A+B	19	47,6	12,8	71	5		900.626.11	
A+B	19	47,6	12,8	71	5			800.626.11
A	19	47,6	12,8	71	10			800.626.11M

Spare parts: **541.515.00** 0,1mm spacer
541.516.00 0,3mm spacer
541.517.00 0,5mm spacer
541.518.00 1mm spacer
541.500.00 3mm spacer

Spare parts

924.083.00	791.005.00	822.364.11	990.020.00
924.131.00	791.005.00	822.364.11	990.020.00
824.131.00	791.005.00	822.364.11	990.020.00
824.131.00	791.005.00	822.364.11	990.020.00



7/8/922A/B

Uses for the CMT 3-Wing Slot Cutter are almost infinite. Cut slots and grooves for splines, biscuits, T-molding or tongue and groove joints.

Every cutter features 3 tungsten carbide tipped cutting edges, CMT's trademark orange non-stick P.T.F.E. coating and boasts an anti-kickback design. CMT slot cutters are available as a blade only or with your choice of a 6, 8, 12, 6,35 or 12,7mm diameter arbor which includes a 22mm diameter bearing for a cutting depth of up to 12,7mm. Other bearings are available in the spare parts section of this catalogue.

NOTE: For 9,5mm or 6,35mm depths, you can order the bearing kit **791.711.00** (with 28,5mm - 34,9mm diameters).

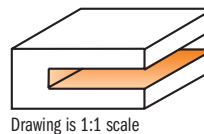
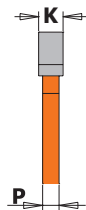
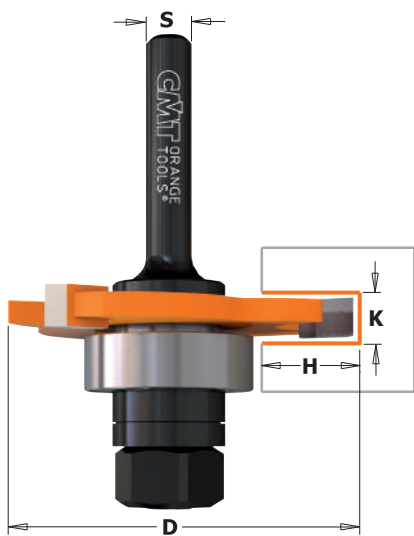

Drawing is 1:1 scale

K mm	P mm	D mm	H mm		ORDER NO. S=Ø6mm	ORDER NO. S=Ø6,35mm	ORDER NO. S=Ø8mm	ORDER NO. S=Ø12mm	ORDER NO. S=Ø12,7mm
1,5	1,1	47,6	12,8	10	722.315.11A		922.315.11A	922.315.11B	
1,6	1,1	47,6	12,8	10		822.316.11A			822.316.11B
2	1,3	47,6	12,8	10	722.320.11A	822.320.11A	922.320.11A	922.320.11B	822.320.11B
2,4	1,3	47,6	12,8	10		822.324.11A			822.324.11B
2,5	1,3	47,6	12,8	10	722.325.11A		922.325.11A	922.325.11B	
3	1,3	47,6	12,8	10	722.330.11A		922.330.11A	922.330.11B	
3,2	1,3	47,6	12,8	10		822.332.11A			822.332.11B
3,5	2,1	47,6	12,8	10	722.335.11A		922.335.11A	922.335.11B	
4	2,1	47,6	12,8	10	722.340.11A	822.340.11A	922.340.11A	922.340.11B	822.340.11B
4,8	2,9	47,6	12,8	10		822.348.11A			822.348.11B
5	2,9	47,6	12,8	10	722.350.11A		922.350.11A	922.350.11B	
6	4,5	47,6	12,8	10	722.360.11A	822.360.11A	922.360.11A	922.360.11B	822.360.11B
6,4	4,5	47,6	12,8	10		822.364.11A			822.364.11B

These 3-wing tungsten carbide tipped cutters feature anti-kickback design and CMT's trademark orange P.T.F.E. Industrial Coating. All cutters feature an 8mm bore. Use these cutters with cutter arbors **724** (Ø6mm diameter), **824** (Ø6,35mm & Ø12,7mm diameters), and **924** (Ø8mm & Ø12mm diameters).

1 7/8/924.xxx.00

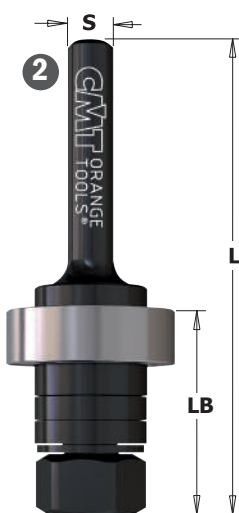

7/8/924.xxx.10

822

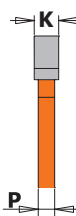
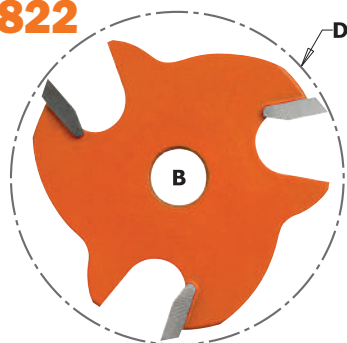

K mm	P mm	D mm	B mm		ORDER NO.
1,5	1,1	47,6	8	10	822.315.11
1,6	1,1	47,6	8	10	822.316.11
1,8	1,3	47,6	8	10	822.318.11
2	1,3	47,6	8	10	822.320.11
2,2	1,3	47,6	8	10	822.322.11
2,4	1,3	47,6	8	10	822.324.11
2,5	1,3	47,6	8	10	822.325.11
2,8	1,3	47,6	8	10	822.328.11
3	1,3	47,6	8	10	822.330.11
3,2	1,3	47,6	8	10	822.332.11
3,5	2,1	47,6	8	10	822.335.11
4	2,1	47,6	8	10	822.340.11
4,8	2,9	47,6	8	10	822.348.11
5	2,9	47,6	8	10	822.350.11
6	4,5	47,6	8	10	822.360.11
6,4	4,5	47,6	8	10	822.364.11

DESCRIPTION	LB mm	L mm		ORDER NO. S=Ø6mm	ORDER NO. S=Ø6,35mm	ORDER NO. S=Ø8mm	ORDER NO. S=Ø12mm	ORDER NO. S=Ø12,7mm
1 Slot cutter arbor without bearing	26	61	10	724.060.00	824.064.00	924.080.00		
1 Slot cutter arbor without bearing	26	67,5	10				924.120.00	824.127.00
2 Slot cutter arbor with bearing	26	61	10	724.060.10	824.064.10	924.080.10		
2 Slot cutter arbor with bearing	26	67,5	10				924.120.10	824.127.10
Slot cutter arbor without bearing, long series	40	86	10			924.083.00		
Slot cutter arbor with bearing, long series	40	86	10			924.083.10		

Spare parts: **791.005.00** Ø8-22mm bearing
541.501.00 4mm spacer
541.500.00 3mm spacer

541.518.00 1mm spacer
990.020.00 M8 nut

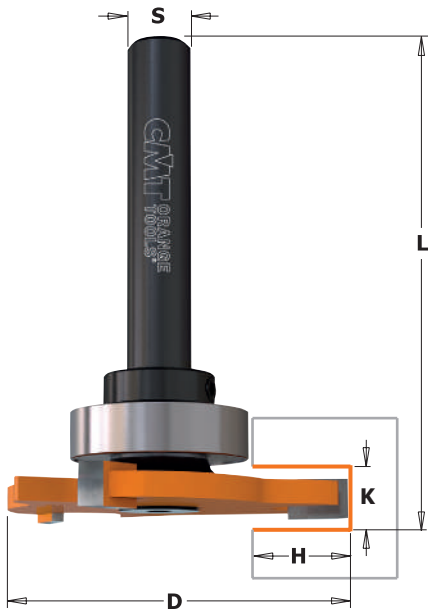

923A - 823B

The uses of this bit are infinite: not only can you rout grooves and rabbets, but you can even create T or dovetail joints and create biscuit and spline recesses on wood panels. Each bit features three carbide-tipped cutters, orange coloured P.T.F.E. coating and anti-kick-back design.

NOTE: This cutter comes with a Ø22mm bearing for 2,8mm depth cuts. By ordering different bearings this depth can be shortened.

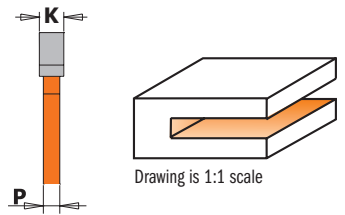

K mm	P mm	D mm	H mm	L mm		ORDER NO. S=Ø8mm	ORDER NO. S=Ø12,7mm
3	1,3	47,6	12,8	58	10	923.330.11A	
3,2	1,3	47,6	12,8	57,5	10		823.332.11B
4	2,1	47,6	12,8	58,3	10	923.340.11A	823.340.11B
5	2,9	47,6	12,8	63	10	923.350.11A	
6,4	4,5	47,6	12,8	60,7	10		823.364.11B

823

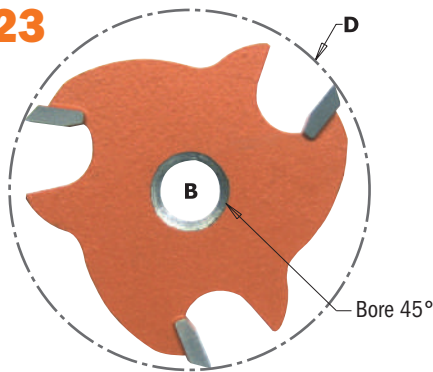

These 3-wing carbide tipped slot cutters feature anti-kickback design and CMT's trademark orange P.T.F.E. Industrial Coating for carrying out lateral grooves. For use with cutter arbors **724** (Ø6mm), **824** (Ø6,35mm & Ø12,7mm) and **924** (Ø8mm).

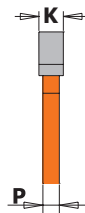

K mm	P mm	D mm	B mm		ORDER NO.
3	1,3	47,6	8	10	823.330.11
3,2	1,3	47,6	8	10	823.332.11
4	2,1	47,6	8	10	823.340.11
5	2,9	47,6	8	10	823.350.11
6,4	4,5	47,6	8	10	823.364.11

7/8/924



with stop collar

8/924



ASSEMBLY ILLUSTRATION

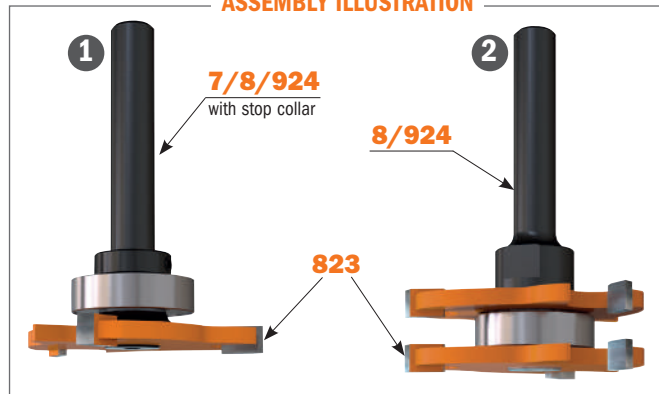

DESCRIPTION	L mm		ORDER NO. S=Ø6mm	ORDER NO. S=Ø6,35mm	ORDER NO. S=Ø8mm	ORDER NO. S=Ø12,7mm
1 Slot cutter arbor without bearing without stop collar	55	10	724.061.00	824.061.00	924.081.00	824.121.00
1 Slot cutter arbor with bearing and stop collar	55	10	724.061.10	824.061.10	924.081.10	824.121.10
2 Slot cutter arbor without bearing	61	10			924.082.00	824.122.00
2 Slot cutter arbor with bearing	61	10			924.082.10	824.122.10

- Spare parts:**
- 791.012.00 Ø8-22mm bearing
 - 541.001.00 Stop collar for Ø6,35mm shanks
 - 541.002.00 Stop collar for Ø12,7mm shanks
 - 791.013.00 Ø12,7-22mm bearing
 - 541.003.00 Stop collar for Ø6mm shanks
 - 541.004.00 Stop collar for Ø8mm shanks

- 541.515.00 0,1mm spacer
- 541.516.00 0,3mm spacer
- 541.517.00 0,5mm spacer
- 541.518.00 1mm spacer
- 990.055.00 M5x12mm TSPEI screw
- 991.067.00 3mm hex key

Flute & Bead Set

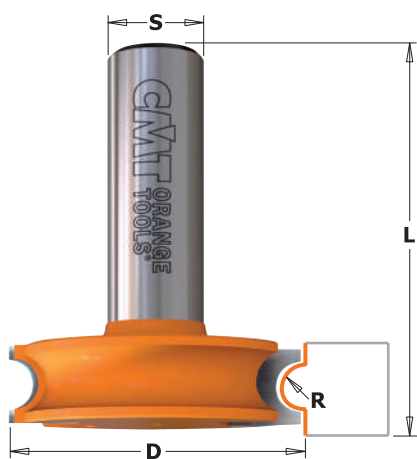

8/955.701

This perfectly mated CMT set is ideal for making wooden canoe slats and hot tub enclosures. The cutting edges in tungsten carbide stay sharp even after cutting large amounts of stock. The anti-kickback design ensures that you work safely. Use both the flute and the bead bits for 6,35mm (1/4") slats as shown below.

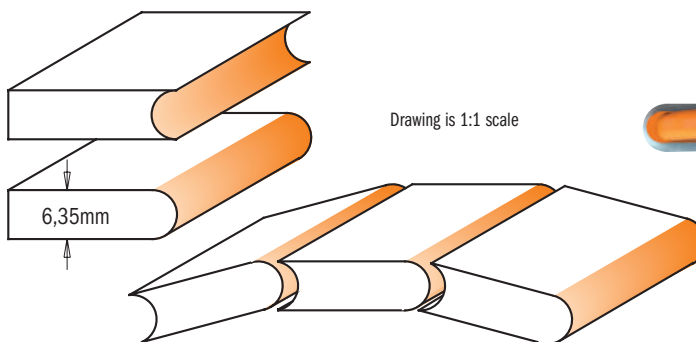

Drawing is 1:1 scale

R mm	D mm	L mm	L ₁ mm				ORDER NO. S=Ø12mm	ORDER NO. S=Ø12,7mm
3,2	38	48,1	44,5	5			955.701.11	855.701.11

Lock Miter Set

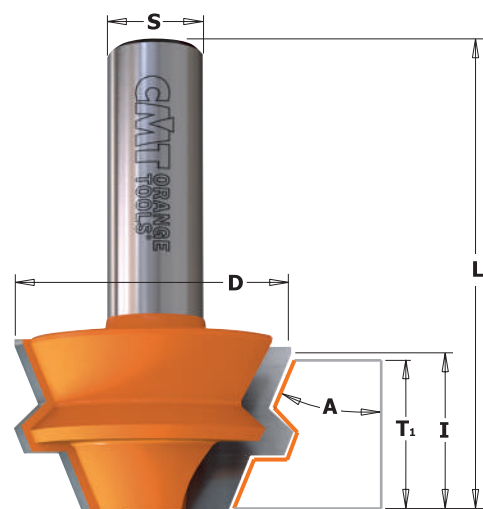

8/955

Use this pair of bits to produce octagonal shaped boxes and popular corner cabinetry for kitchens, kitchen islands, entertainment centres and corner hutches.

This 22.5° Lock Miter set provides a strong tight joint even at 45° angles.

After the joints are machined, they can be glued and assembled or simply clamped by using strapping tape.

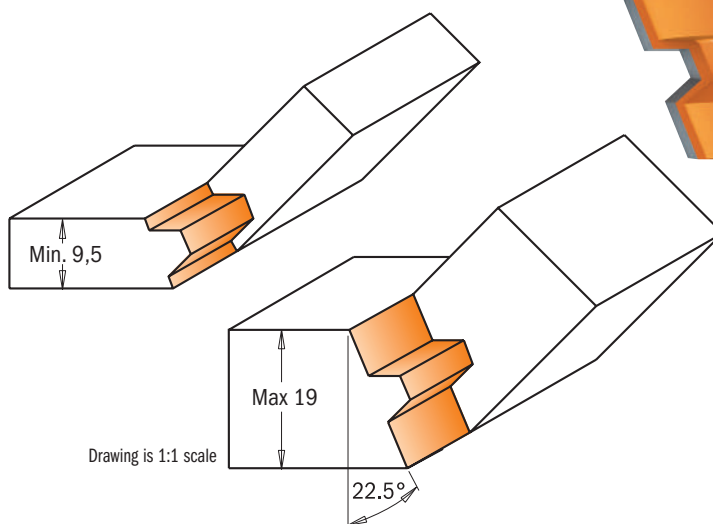

Drawing is 1:1 scale

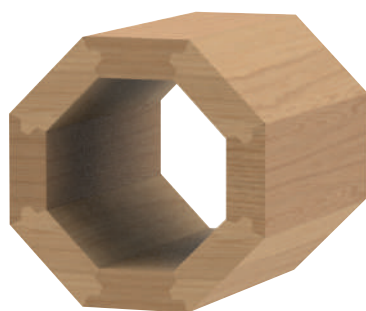

D mm	I mm	A	T ₁ mm	L mm			ORDER NO. S=Ø8mm	ORDER NO. S=Ø12,7mm
37,3	22,2	22,5°	9,5 ÷ 19	60,3	5		955.005.11	855.505.11



8/955.504

These are the ultimate bits to craft sturdy miter joints thanks to anti-kickback design and tough tungsten carbide cutting edges. By adding a second smaller bit, you can mill anywhere from 9,5mm to 28,5mm in thickness. A quick and easy way to accurately create boxes, stretcher bars, frames and any assortment of right angle or parallel joint projects.

You also have the advantage of using the same bit for parallel joinery projects. To mill sturdy parallel glue joints follow step 1 shown in the illustration with the inside face of the workpiece laid flat on the table and centred to the bit. To make the second part, lay the workpiece flat on the table and centred to the bit. Mill with the inside face-up.

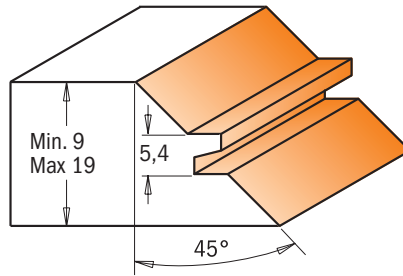

8/955.503

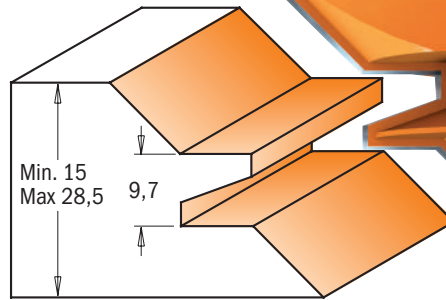

Drawing is 1:1 scale

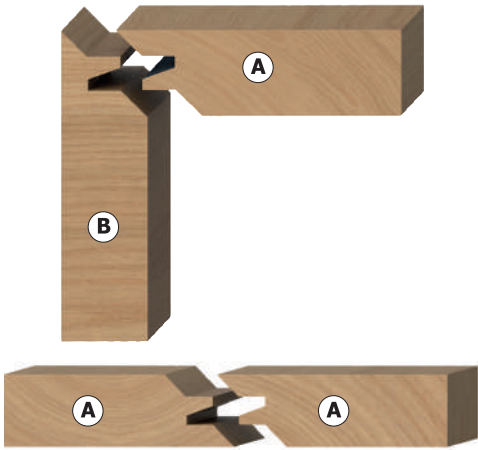

FOR MITER AND PARALLEL GLUE JOINTS USING 19MM BOARD

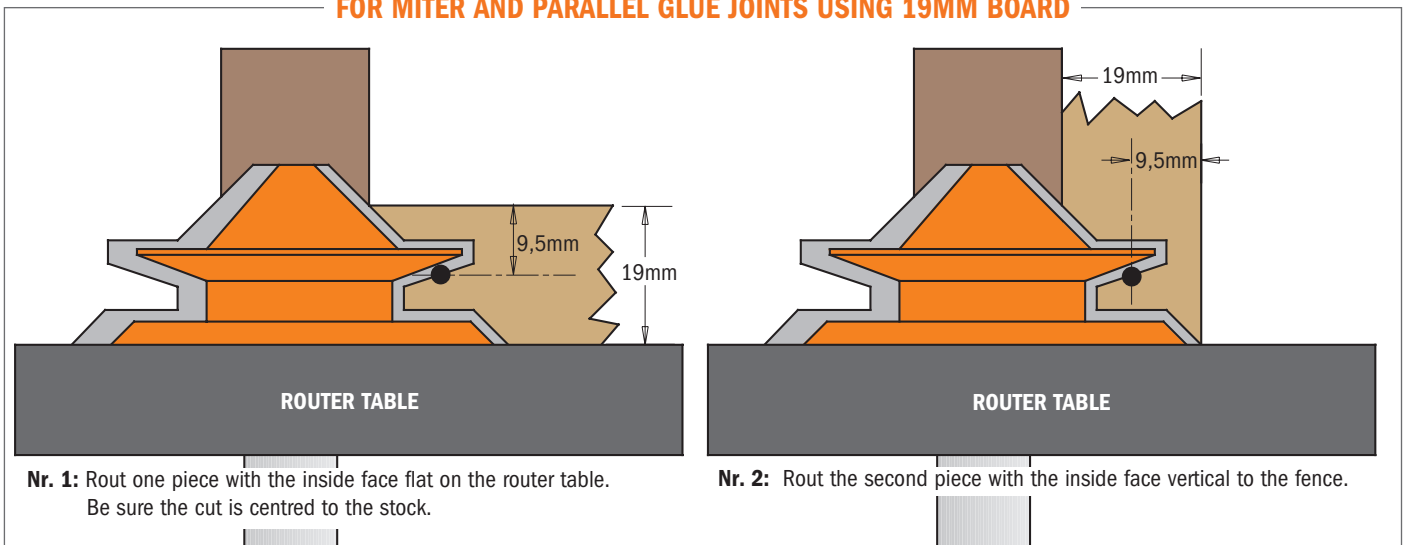

Nr. 1: Rout one piece with the inside face flat on the router table. Be sure the cut is centred to the stock.

Nr. 2: Rout the second piece with the inside face vertical to the fence.

D mm	I mm	A	T ₁ mm	L mm		ORDER NO. S=Ø8mm	ORDER NO. S=Ø12mm	ORDER NO. S=Ø12,7mm
44,5	19	45°	9 ÷ 18	58	5	955.009.11		
50,8	21	45°	9,5 ÷ 19	60,3	5		955.504.11	855.504.11
70	30	45°	15 ÷ 28,5	70	5		955.503.11	855.503.11

Reverse Glue Joint Bits



8/955.501

The most unique and important characteristic of this CMT bit is its capacity to produce a virtually indestructible glue joint quickly and flawlessly. Ideal for routing panels, doors and furniture pieces of wide dimension, panels, doors and furniture pieces. Refer to page 248, "ABCs of Panel Door Construction".

By accurately centering the bit to the wood, the upper and lower vertical cutting edges of the bit will cut equal proportions. Simply run one edge of the panel, turn the panel over, and then run the opposite edge - you will craft perfectly harmonized reverse cuts that match up to produce immaculate joints!

SHOP TIPS: When glueing, apply enough pressure to securely seal the joint. Insufficient pressure results in a weak joint and excessive pressure will distort the wood.

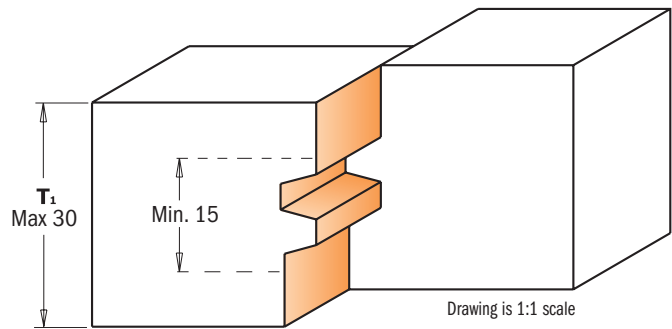
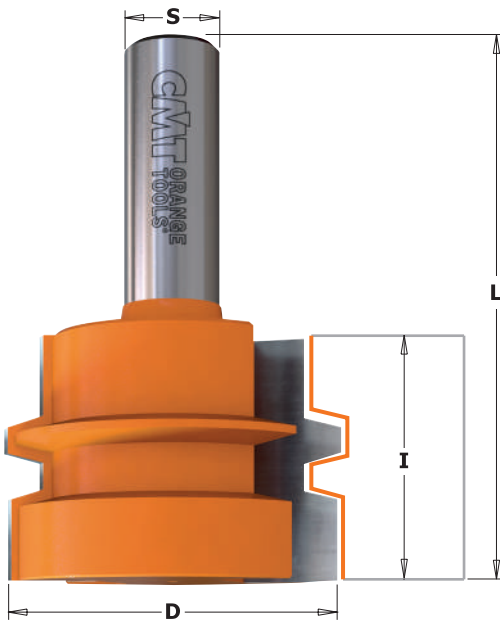

EXAMPLE USING A 19MM BOARD

Accurately centre the wood to the bit: Adjust the bit according to the thickness of the wood you are cutting. Line up the cut edge of the wood to the centre point of the bit as illustrated in the enlarged drawing. The upper and lower vertical cutting edges of the bit are in proportion and at an equal distance from the centre point of the bit. Run one cut edge of the wood, turn the piece over and run the other edge for exact reverse cuts that match up perfectly. Assemble the reverse cut pairs together for beautiful, strong joints.

D mm	I mm	T ₁ mm	L mm		ORDER NO. S=Ø12mm	ORDER NO. S=Ø12,7mm
44,4	32	15 - 30	70,1	10	955.501.11	855.501.11

Drawer Lock Bits

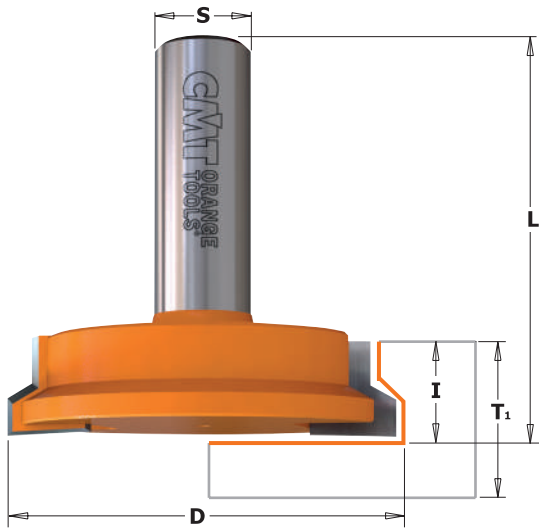

7/8/955

With CMT drawer lock bits you can make strong, perfectly fitted joints quickly and easily. Follow the example below to create perfect drawers.

WARNING! These bits are to be used on router tables only with a fence. Do not use on hand-held routers.



8/955.002-502

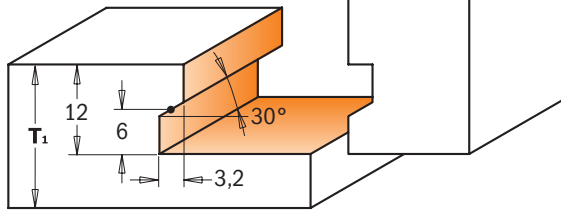

Drawing is 1:1 scale

855.508 955.008

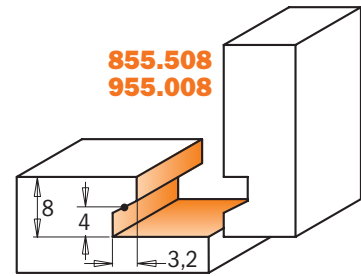

Drawing is 1:1 scale

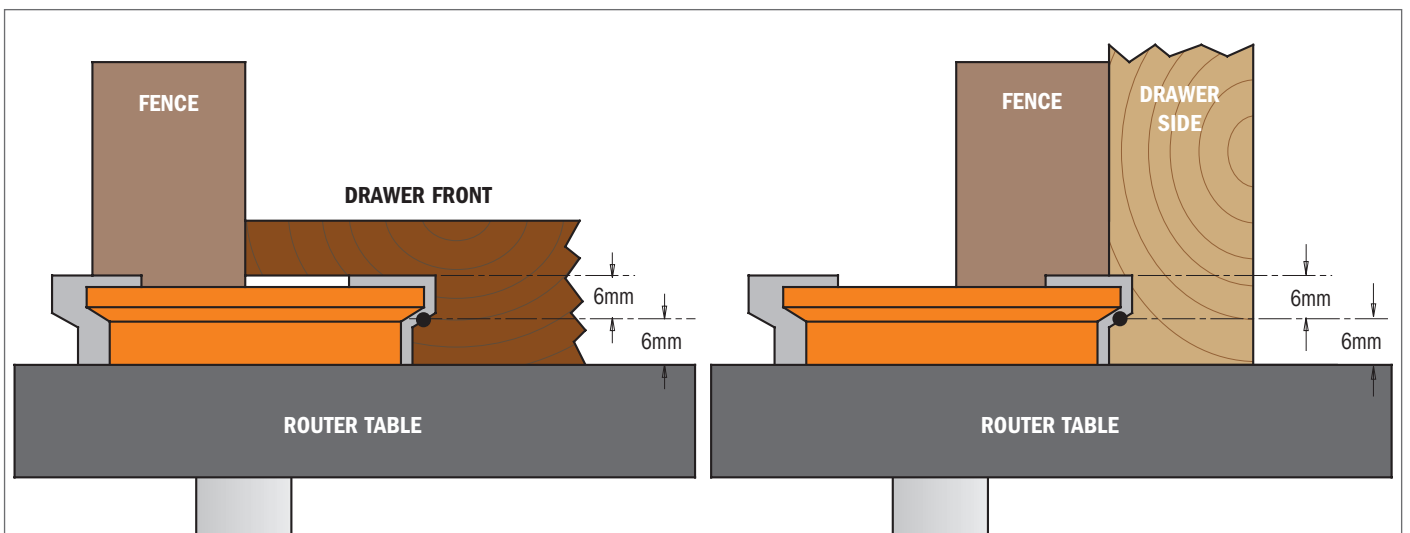
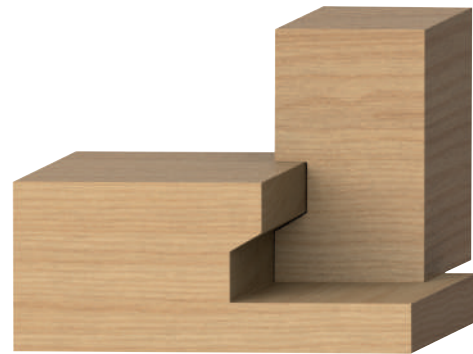
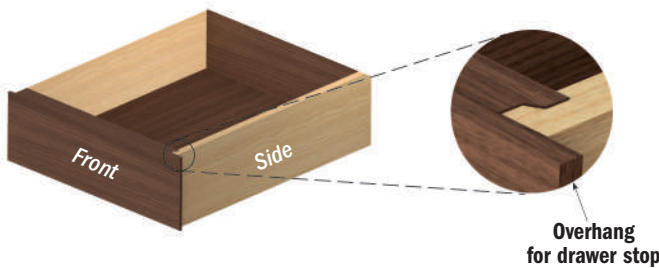

D mm	T ₁		I mm	L mm	Box Icon	ORDER NO. S=Ø6mm	ORDER NO. S=Ø6,35mm	ORDER NO. S=Ø8mm	ORDER NO. S=Ø12mm	ORDER NO. S=Ø12,7mm
	min. mm	max. mm								
25,4	9,5	15,87	12,7	54	10			955.008.11		855.508.11
31,7	15,87	25,4	12,7	44,5	10	755.002.11	855.002.11	955.002.11		
50,8	15,87	25,4	12,7	50,8	10				955.502.11	855.502.11



8/955.801

CMT designed this set so you can create window sashes that are as beautiful as they are functional. You can craft perfect 12,7mm profiles for custom doors.

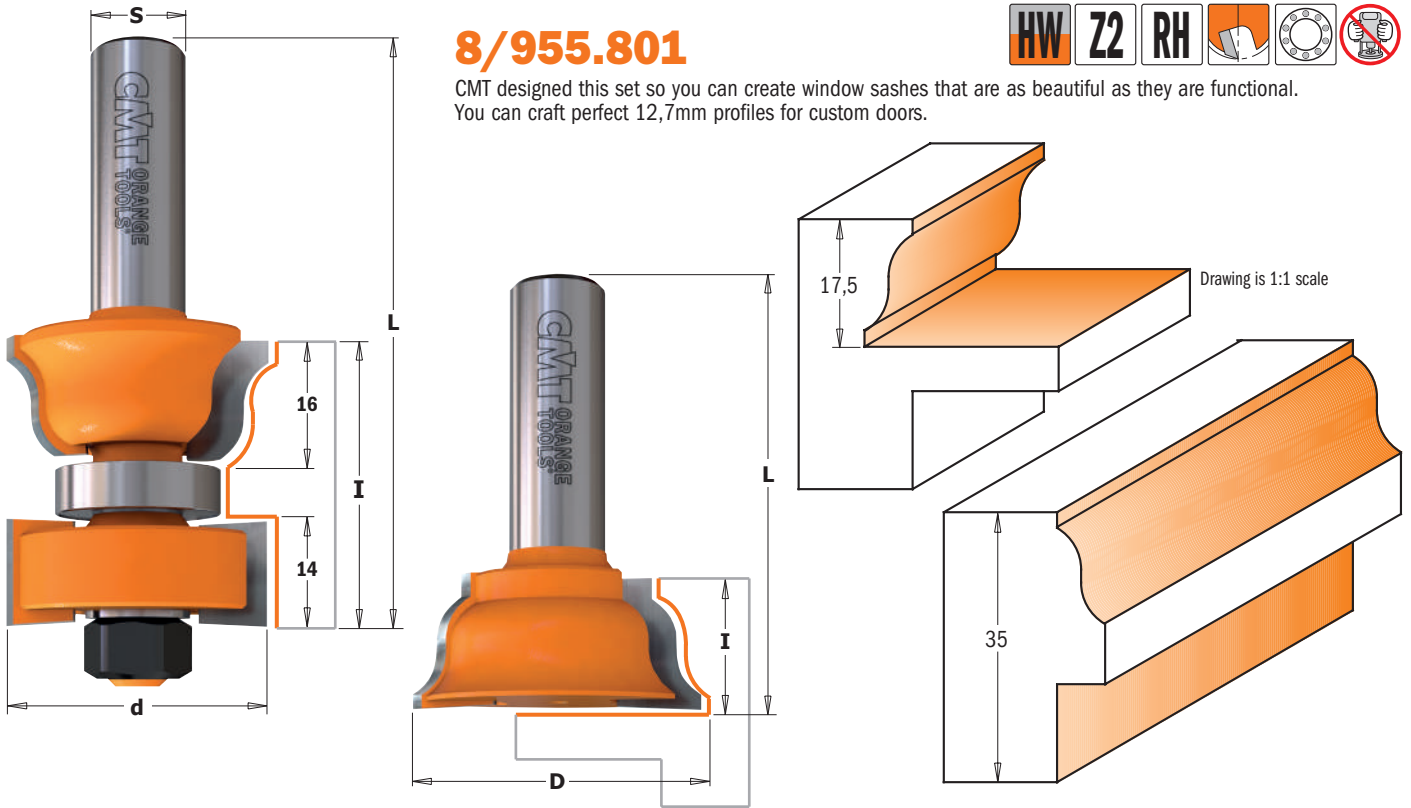

d mm	l mm	L mm	D mm	I mm	L mm		ORDER NO. S=Ø12mm	ORDER NO. S=Ø12,7mm
35	35	84	38	17,5	56	5	955.801.11	855.801.11

Spare parts

791.012.00	822.004.11	541.518.00	990.020.00

STEP-BY-STEP WINDOW SASH CONSTRUCTION

CMT set makes it easy!

In our step-by-step example for window sash construction, we used the following:

- CMT Window Sash Set (item #855.801.11)
- stiles cut 35mm thick
- rails cut 35mm thick
- scrap stock

The CMT Window Sash Set was designed ideally for the construction of windows in 35mm stock, however variations as narrow as 28mm can be used. Stock thicker than 35mm exceeds the milling range of the cutter. Remember to adjust your measurements and cutting depths according to the wood thickness you use. We suggest making a trial joint in scrap stock according to the following steps before milling all of the cope and stick Profiles.

STEP 1 - Measurements and making the tenons

The ideal thickness of the stiles when using the CMT sash set is 35mm. The desired width of the stiles will determine the length you need to make your tenons, while the length of the stile will represent the desired full height of the sash. When cutting the rails to length, make sure to add the length of the two tenons to the overall length of the rail. The length of the tenons should be at least half the width of the stile. Mill 16mm measuring from the front face of the stock using a table saw, radial saw or router as shown in illustration 1. This measurement remains invariable since it is calculated to the height of the CMT sash routers. The width of the tenon is 6mm. Rotate the stock and mill the other side. As per our example, the second milling will be 13mm but this measurement will vary if you are using thinner stock.

STEP 2 - Making the cope Profilee on rails, sash bar and muntins

To make the cope Profilee, place the rail face front down on the router table with the tenon flush to the bit as shown in illustration 2. Adjust the fence so the bit mills 6,35mm deeper than the tenon. To mill the sash bar and the muntins (cross bars), position front face down on the router table and mill without changing the height of the bit.

STEP 3 - Making the stick Profilee on rails, stile, sash bar and muntins

To mill the stick Profilee along the inside edges of all sash parts, place the already milled cope Profilee front face down on the router table and adjust the sash bit so that the lower edge of the top cutter will exactly touch the upper edge of the tenon as shown in need to 3 illustrations. With the rail still face down on the table, turn it so the inside edge of the rail is touching the bit and mill the stick Profilee. Mill the inside edges of the stiles and mill both edges of the front face of the sash bar and muntins. To cut the slots for the tenons, measure 16mm from the front face of the stiles and rout with a table saw.

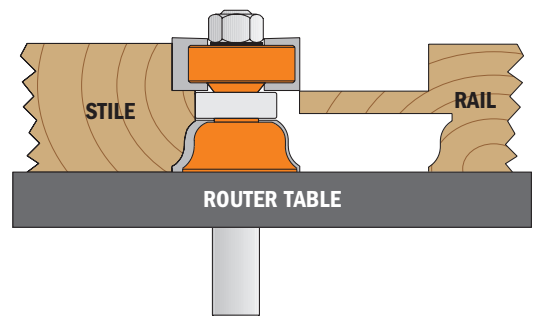
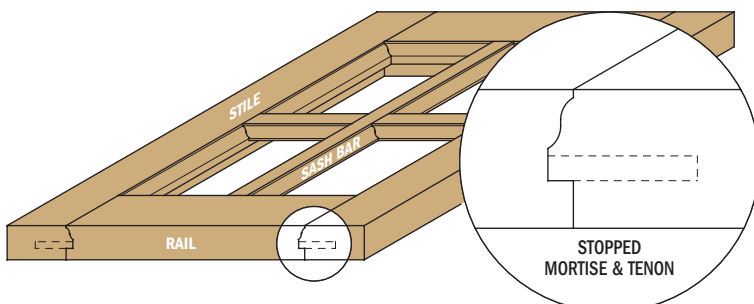
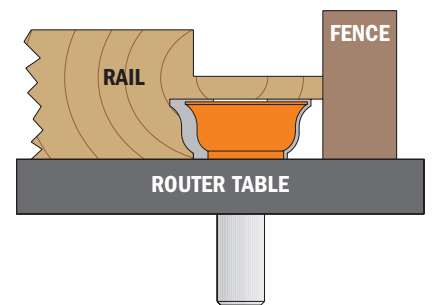
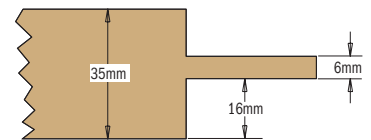

Ovolo Sash Bits

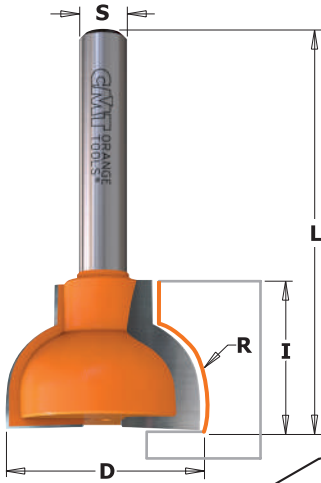

8/955.3

These bits allow you to make true divided light doors for fine furniture and cabinets as well as sash bar windows, and stile and rail constructions. The glazing bar ovolo bits are bearing-guided to enable curved frames to be moulded. Cove bits can be used to produce easy-to-pull drawer handles.

Drawing is 1:1 scale

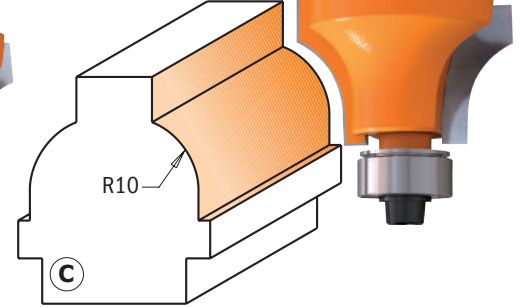
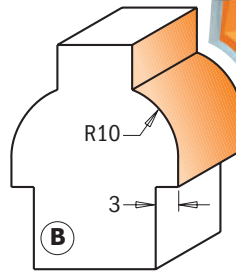
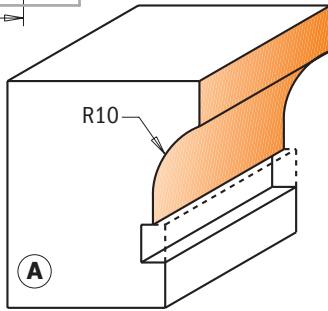
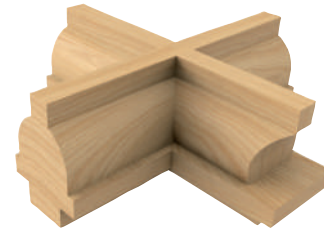

D mm	I mm	R mm	L mm	PROFILE		ORDER NO. S=Ø6,35mm	ORDER NO. S=Ø8mm
25	19	10	50,8	A	10	855.307.11M	955.307.11M
22	19	10	50,8	B	10	855.307.11F	955.307.11F
28	19	10	61,2	C	10	855.308.11F	955.308.11F

Spare parts

990.423.00	791.003.00	990.058.00	991.057.00

Ovolo Sash Set



955.302 - 855.802

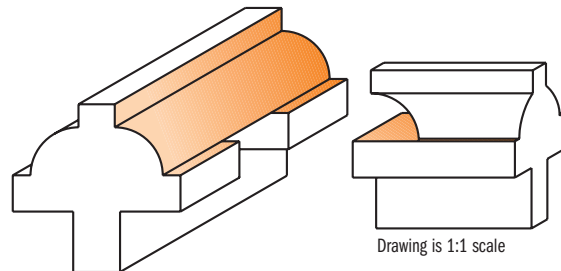
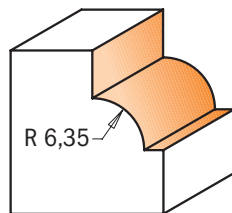
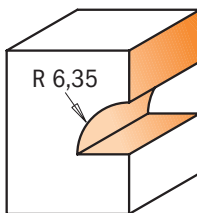
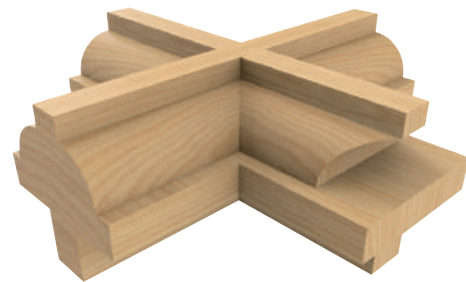

Drawing is 1:1 scale

d mm	D mm	I mm	R mm	L mm	L ₁ mm		ORDER NO. S=Ø8mm	ORDER NO. S=Ø12,7mm
30	31,7	12	6,35	57	61	5	955.302.11	855.802.11

Spare parts

990.423.00	791.003.00	990.058.00	791.011.00	541.002.00

Spare parts: 991.056.00 1,5mm hex key
991.057.00 3/32" hex key

Finger Joint Bit



8/900.616

This router allows you to carry out accurate and functional finger joints with the greatest of ease. Without any adjustment you will be able to work woods with different thicknesses as indicated in the drawing. The bearing allows you to reach a 9,5mm cutting depth. For further cutting depths you need to use a fence.

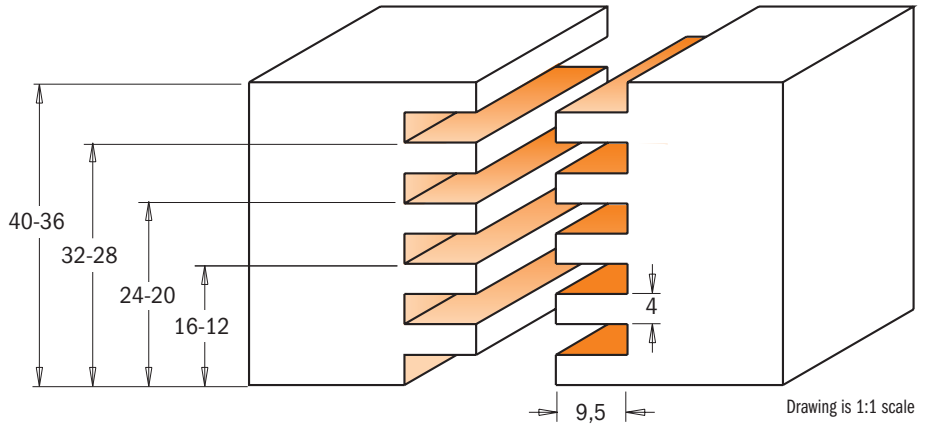
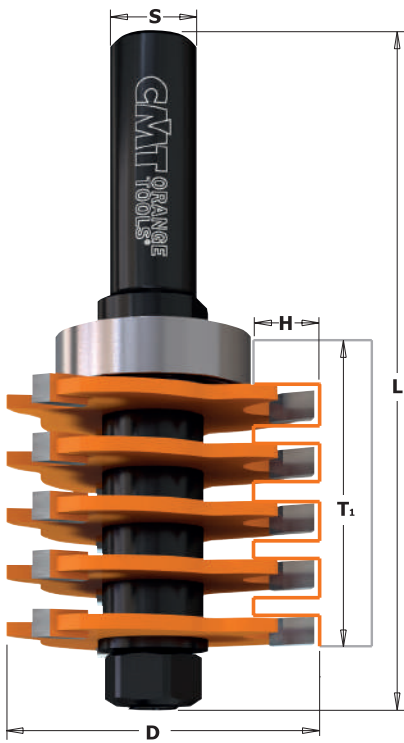

Drawing is 1:1 scale

T ₁ mm	D mm	H mm	L mm		ORDER NO. S=Ø12mm	ORDER NO. S=Ø12,7mm
12 - 40	47,6	9,5	97	10	900.616.11	
12 - 40	47,6	9,5	97	10		800.616.11

Spare parts

924.130.00	791.027.00	822.340.11	990.020.00
824.130.00	791.027.00	822.340.11	990.020.00

Spare parts: 541.515.00 0,1mm spacer
 541.519.00 5,8mm spacer
 990.403.00 1,6mm washer
 990.459.00 Kit with spacers

Optional: 791.020.00 Ø38,1mm bearing (for depth 4,75mm)
 791.029.00 Ø34,9mm bearing (for depth 6,35mm)
 791.015.00 Ø31,7mm bearing (for depth 8mm)
 791.011.00 Ø19mm bearing (for depth 14,3mm)

Professional Finger Joint Bit

8/900.606

This versatile finger joint bit is the perfect tool for making incredibly strong side-to-side or end-to-end joints in wood and in varying lengths from 12.7mm to 36mm. The tightness and accuracy of the cut joint coupled with the maximum glue surface create a joint that is actually stronger than an unworked piece of wood.

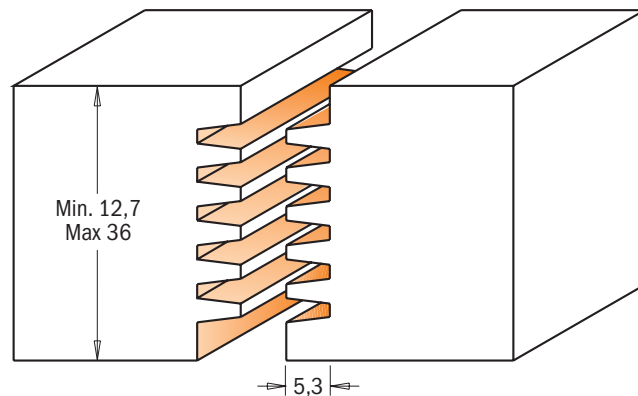
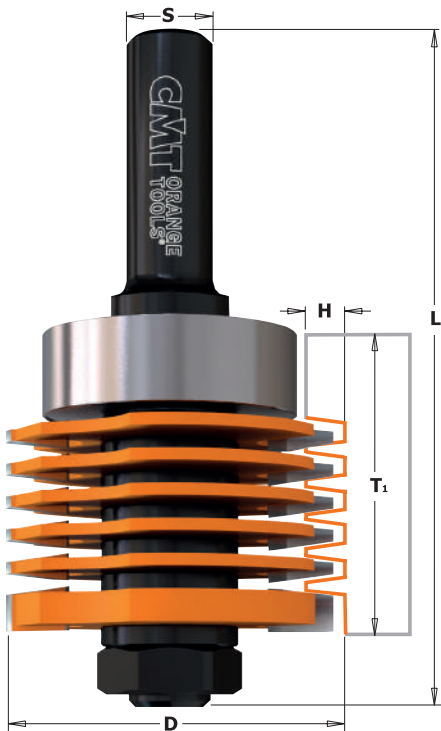

Drawing is 1:1 scale

T ₁ mm	D mm	H mm	L mm		ORDER NO. S=Ø12mm	ORDER NO. S=Ø12,7mm
12,7 - 36	47,6	5,3	97	10	900.606.11	
12,7 - 36	47,6	5,3	97	10		800.606.11

Spare parts

824.129.00	791.028.00	822.005.11	990.022.00
924.129.00	791.028.00	822.005.11	990.022.00

Spare parts: 541.511.00 3mm spacer
 541.512.00 2mm spacer
 541.526.00 0,1mm spacer
 990.458.00 Kit with spacer

V-Tongue & Groove Set

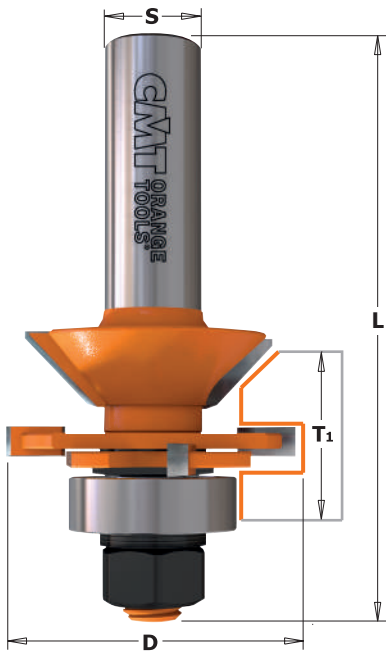

8/955.506

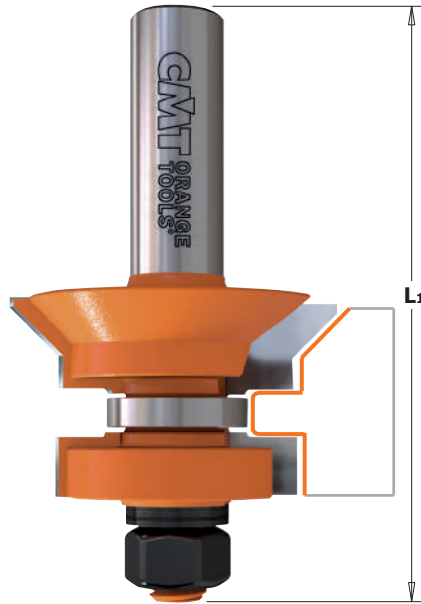

If the standard selection of moulding and mill work you find in today's lumber shops isn't satisfactory to your woodworking tastes, then consider CMT's moulding system instead. With these bits, you can make dozens of elaborate profiles by combining two or more passes. Avoid the average and create your own mouldings. Some initial suggestions are illustrated below.

SAFETY TIPS: use these bits with a fence. The profiles shown below are milled from heavy stock then refined to the desired shape.

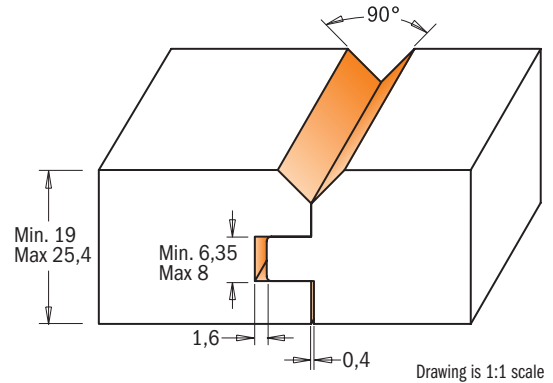

Drawing is 1:1 scale

D mm	T ₁ mm	L mm	L ₁ mm		ORDER NO. S=Ø12mm	ORDER NO. S=Ø12,7mm
44,4	19÷25,4	75,5	78,5	10	955.506.11	855.506.11

Spare parts

822.013.11	822.014.11	791.011.00	791.005.00	990.020.00

Spare parts: **541.515.00** 0,1mm spacer
541.516.00 0,3mm spacer
541.517.00 0,5mm spacer
990.407.00 Shield

Edge Banding Bits Set

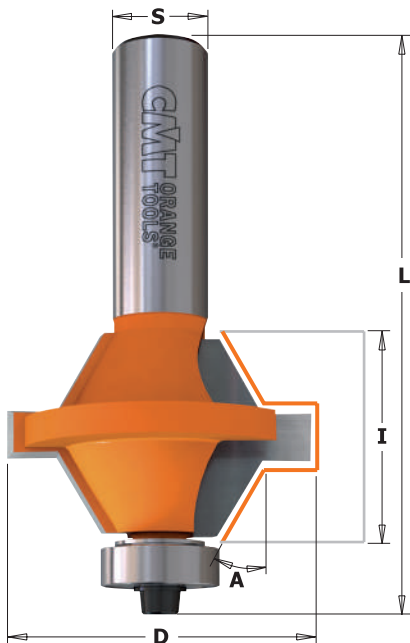

8/955.510

This is a great set to create cost-effective, yet attractive durable edges to your cabinet doors. For use with 12,7mm or 25,4mm thick panels in plywood or MDF. Easy to use: center each cutter on the stock and make the cut; glue the two pieces together; flush trim after assembly, if necessary. The set features a 60° angle tongue & groove with an ample surface area for glue application.

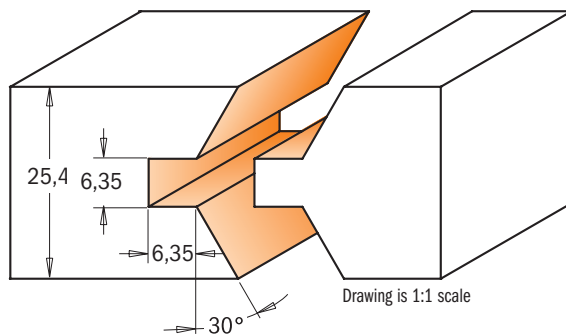

Drawing is 1:1 scale



D mm	I mm	A	L mm		ORDER NO. S=Ø12mm	ORDER NO. S=Ø12,7mm
40	25,4	30°	74,5	5	955.510.11	855.510.11

Spare parts

990.423.00	791.018.00	990.058.00	991.057.00

Dovetail Bits

7/8/918 - 7/818B



The beautifully crafted dovetail joint is a classic that appeals to both professionals and novices alike.

SHOP TIPS: Two passes are recommended when routing dovetails with a template. Check that the dovetails have been cut through completely and smoothly before removing the workpiece. For even easier routing and less stress on your dovetail bit, run the first pass with a straight bit. Use a dovetail on your router table equipped with a fence to achieve difficult chamfer angles.

SAFETY TIPS: If the dovetail bit jams while working, adjust the position of the bit in the collet and ensure the cutting depth is appropriate. Do not lift the router out of the template.

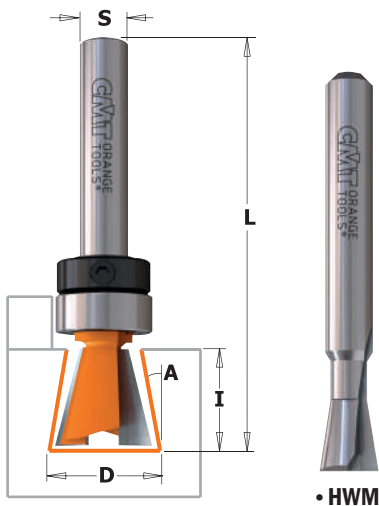

Drawing is 1:1 scale

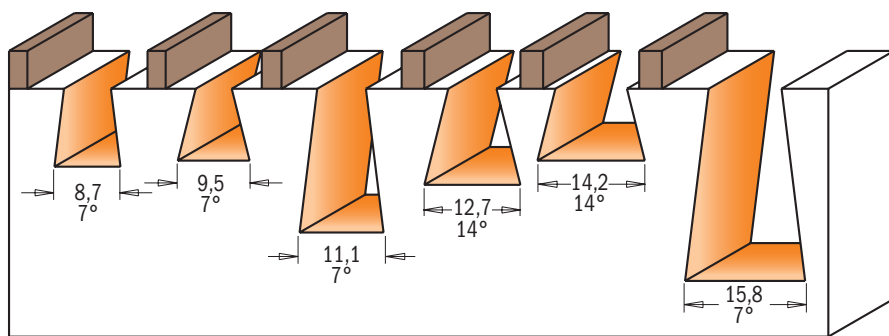
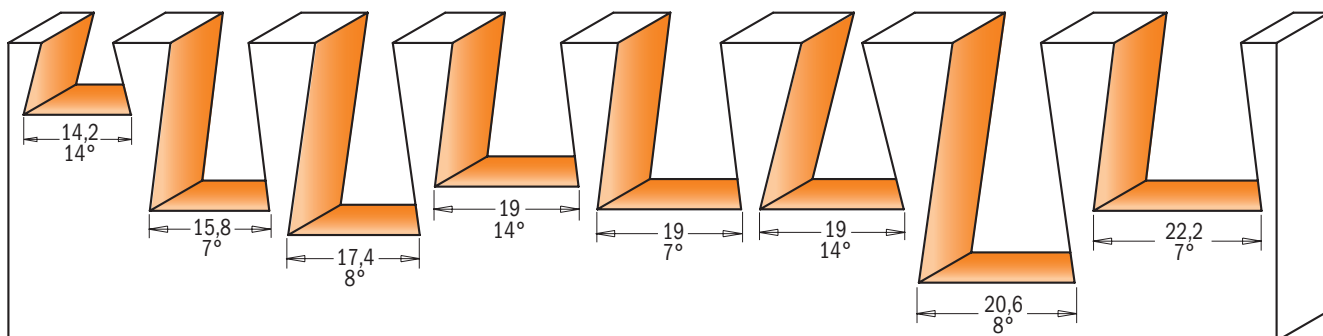
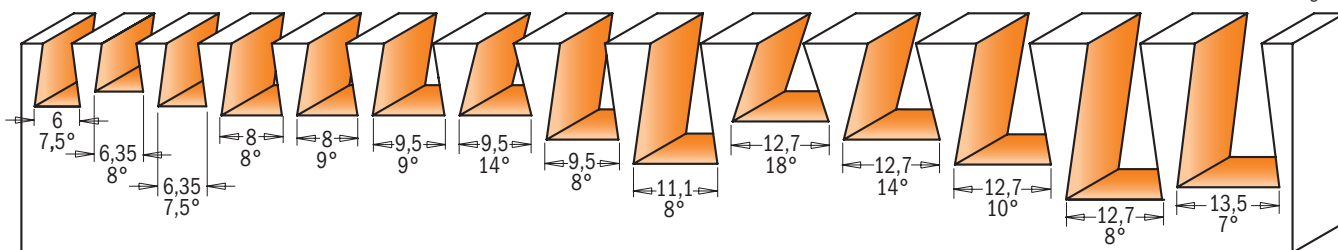

Fit Manufacturer Model	ORDER NO.	
CMT-Enlock10		818.098.11B
CMT-Enlock15	718.127.11B	818.128.11B
CMT300	718.127.11	818.128.11
	918.127.11	818.628.11

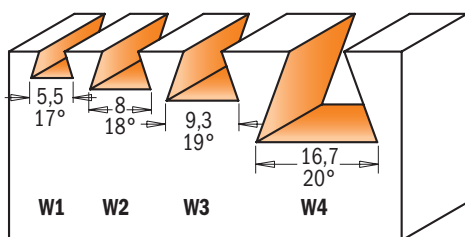

FIT HOFFMANN® KEYS

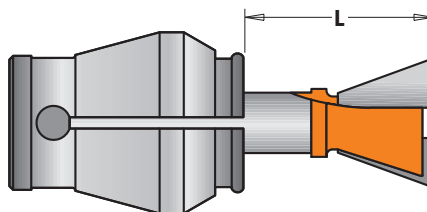

Manufacturer/Model	ORDER NO.	
FIT HOFFMANN® KEYS		
W1 L=16mm	718.053.11	818.053.11
W2 L=17,5mm	718.079.11	818.079.11
W3 L=19mm	718.093.11	818.093.11
W4 L=25mm	918.167.11	

7/8/918

D mm	I mm	L mm	A		ORDER NO. S=Ø6mm	ORDER NO. S=Ø6,35mm	ORDER NO. S=Ø8mm	ORDER NO. S=Ø12mm	ORDER NO. S=Ø12,7mm
•6	8,3	60	7,5°	10	718.060.11				
•6,35	6,35	50,8	8°	10		818.065.11			
•6,35	8,3	63,5	7,5°	10		818.064.11			818.564.11
•8	9,5	54	8°	10		818.081.11			
•8	9,5	52,5	9°	10		818.080.11			
•8	9,5	63,5	9°	10					818.580.11
•9,5	9,5	60,3	14°	10		818.098.11			
9,5	9,5	52,5	9°	10	718.095.11	818.096.11	918.095.11		
9,5	9,5	63,5	9°	10					818.596.11
9,5	12,7	60,3	8°	10		818.097.11			
11,1	15,9	60,3	8°	10		818.111.11			
12,7	10,3	60,3	18°	10		818.132.11			
12,7	12,7	52,4	14°	10	718.127.11	818.128.11	918.127.11		
12,7	12,7	63,5	14°	10					818.628.11
12,7	12,7	62	14°	10		818.130.11			
12,7	16	60,3	10°	10		818.133.11			
12,7	20,6	69,8	8°	10		818.129.11	918.129.11		
13,5	19,05	61,5	7°	10					818.635.11
14,2	9,5	50,8	14°	10		818.142.11			
15,8	22	60,3	7°	10	718.158.11	818.158.11	918.158.11		
15,8	22	66,7	7°	10				918.658.11	818.658.11
17,4	25,4	77,6	8°	10					818.674.11
19	19	77,6	14°	10					818.691.11
19	22	60,3	7°	10	718.190.11	818.190.11	918.190.11		
19	22	66,7	7°	10				918.690.11	818.690.11
19	22	60,3	14°	10		818.191.11			
20,6	31,7	84,1	8°	10					818.706.11
22,2	22,2	69,8	7°	10					818.722.11
WITH TOP BEARING									
8,73	10,3	58	7°	10		818.087.11B			
•9,5	9,5	60,3	14°	10		818.098.11B			
11,1	19	66,7	7°	10		818.113.11B			
12,7	12,7	52,4	14°	10	718.127.11B	818.128.11B			
14,2	9,5	50,8	14°	10		818.142.11B			
WITH TOP BEARING (SHANK=Ø9,5mm)									
15,8	25,4	68,3	7°	10			818.159.11B		
FIT HOFFMANN® KEYS									
•5,5	4	43	17°	10	718.053.11	818.053.11			
•8	6	43	18°	10	718.079.11	818.079.11			
•9,3	7,3	43	19°	10	718.093.11	818.093.11			
16,7	12,5	49	20°	10			918.167.11		



Spare parts

791.009.00	541.001.00
791.010.00	541.001.00
791.009.00	541.001.00
791.010.00	541.001.00
791.010.00	541.001.00
791.021.00	541.006.00

Spare parts: **990.005.00** M3x3mm TSEI screw
991.056.00 1,5mm hex key

• HWM



A FEW OF THE BEAUTIFUL DOVETAIL JOINTS YOU CAN PRODUCE USING CMT BITS

Through Dovetail	Half-Blind dovetail	Variable-Spaced Dovetail	Sliding Dovetail

9° Dovetail Cutters

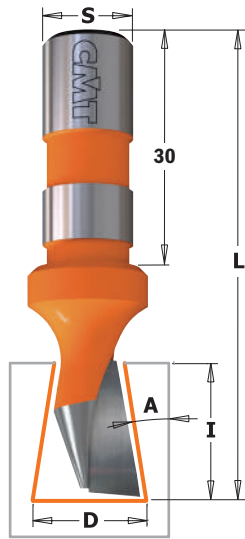

522



D mm	I mm	L mm	A	S mm		ORDER NO. Right-hand rotation
14	18	60	9°	12	10	522.140.11

TECHNICAL DETAILS:

- Strength steel.
- 1 HW precision ground cutting edge [Z1].

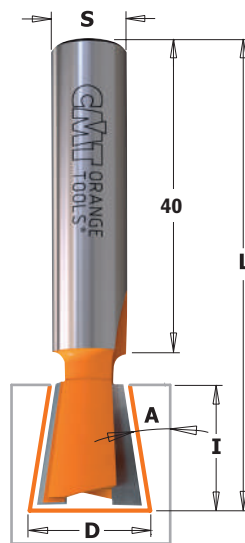
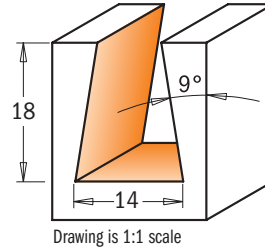

523



D mm	I mm	L mm	A	S mm		ORDER NO. Right-hand rotation
14	16	60	9°	10	10	523.140.11

TECHNICAL DETAILS:

- Strength steel.
- 2 HW precision ground cutting edges [Z2].

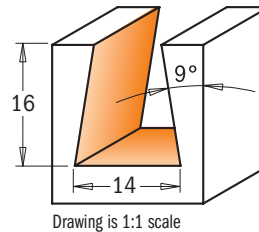

15° Dovetail Cutter with Insert Knives for Roof-Frames

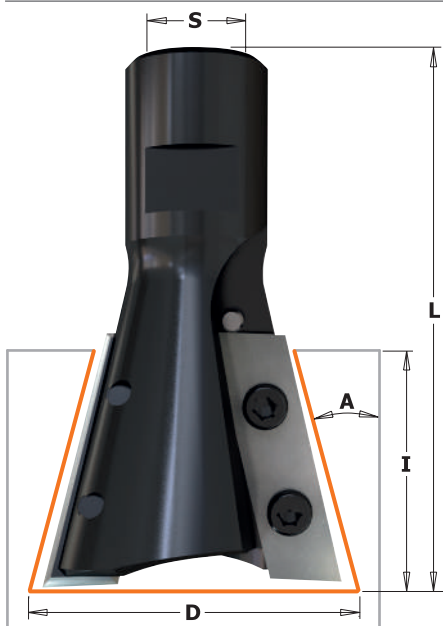

664



D mm	I mm	L mm	A	S mm		ORDER NO. Right-hand rotation
39,5	31,5	66	15°	M12x1	1	664.395.11

TECHNICAL DETAILS:

- Strength steel.
- 2 HWM precision insert knives [Z2].

APPLICATION:

This cutter allows you to assemble roof-frames by dovetailing.

Spare parts

790.315.00	990.076.00	991.061.00

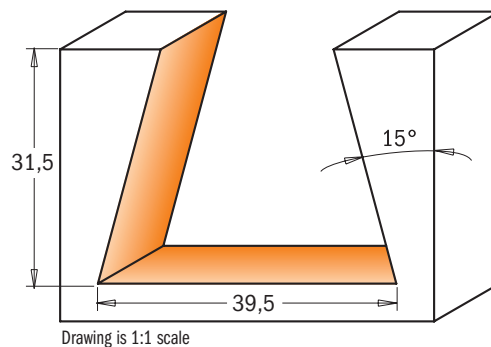

SAFETY TIPS

The **TW-006** Torque Screwdriver is recommended for the proper fastening of screws (see page 413).

60° Lettering Bit

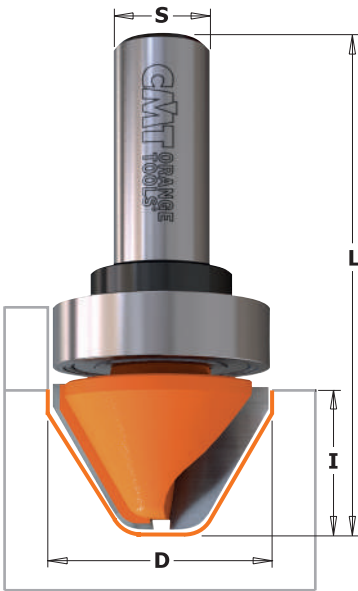

8/949B

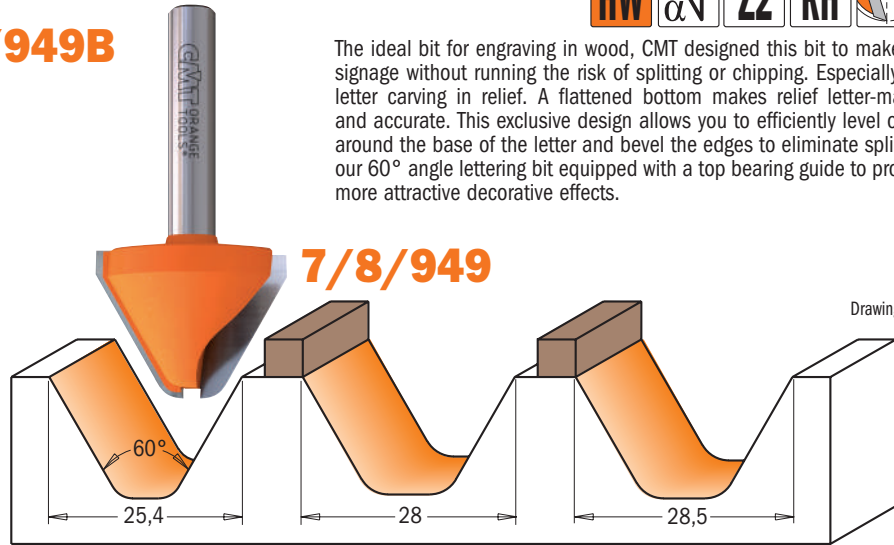

The ideal bit for engraving in wood, CMT designed this bit to make attractive signage without running the risk of splitting or chipping. Especially useful for letter carving in relief. A flattened bottom makes relief letter-making easy and accurate. This exclusive design allows you to efficiently level off the area around the base of the letter and bevel the edges to eliminate splintering. Try our 60° angle lettering bit equipped with a top bearing guide to produce even more attractive decorative effects.

D mm	I mm	A	L mm		ORDER NO. S=Ø6mm	ORDER NO. S=Ø6,35mm	ORDER NO. S=Ø12mm	ORDER NO. S=Ø12,7mm
25,4	19	60°	50,8	10	749.001.11	849.001.11		
28	19	60°	63,5	10			949.502.11	
28,5	19	60°	63,5	10				849.501.11
WITH TOP BEARING								
28	19	60°	63,5	10			949.502.11B	
28,5	19	60°	63,5	10				849.501.11B

Spare parts		
791.026.00	541.005.00	991.056.00
791.027.00	541.002.00	991.056.00

Spare parts: 990.005.00 M3x3mm STEI screw

Bowl & Tray Bits

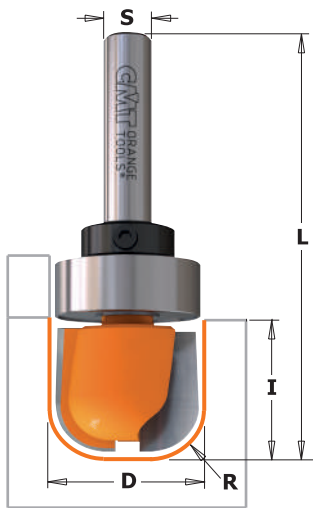

7/8/951B



7/8/951

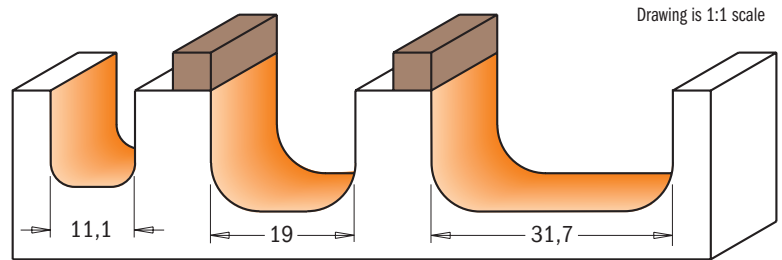

This CMT bit is ideal for making bowls, trays, boxes, cutting boards or any other specialty or craft item. The round corner of the bit shapes the inner radius while the sides and bottom create the smooth flat surfaces. We recommend using a top bearing for accurate and easy pattern work.

TIPS: use these bits on a table router with bearing guide for decorative edgework.

D mm	I mm	R mm	L mm		ORDER NO. S=Ø6mm	ORDER NO. S=Ø6,35mm	ORDER NO. S=Ø8mm	ORDER NO. S=Ø12mm	ORDER NO. S=Ø12,7mm
11,1	12,7	3,2	45,5	10		851.001.11			
19	16	6,4	54	10	751.002.11	851.002.11	951.002.11		
19	16	6,4	60,4	10				951.501.11	851.501.11
31,7	16	6,4	60,4	10				951.502.11	851.502.11
WITH TOP BEARING									
19	16	6,4	54	10	751.002.11B				
19	16	6,4	54	10		851.002.11B			
19	16	6,4	60,4	10					851.501.11B
31,7	16	6,4	60,4	10				951.502.11B	851.502.11B

Spare parts		
791.007.00	541.003.00	991.056.00
791.004.00	541.001.00	991.056.00
791.011.00	541.002.00	991.056.00
791.015.00	541.002.00	991.056.00

Spare parts: 990.005.00 M3x3mm STEI screw

V-Grooving Bits (90°)

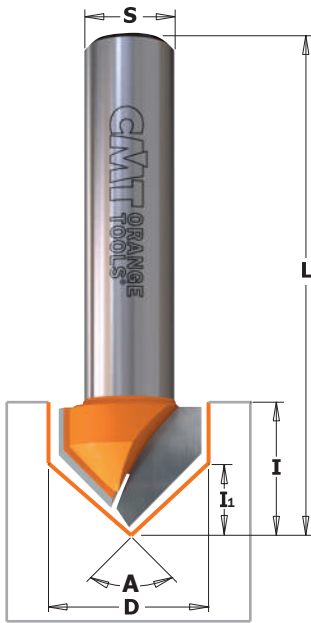

7/8/915



These double cutting edge CMT bits offer an almost endless range of woodworking possibilities. Make clean, perfect cuts in panels, drawer fronts or even plasterboard panels; chamfer edges or engrave beautiful lettering.

TIPS: these bits perfectly chamfer at 45° angles (Two tools in one).

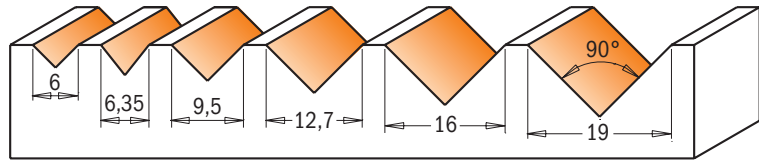

Drawing is 1:1 scale

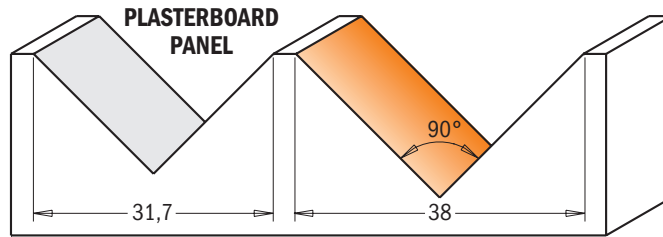

D mm	I mm	I ₁ mm	A	L mm		ORDER NO. S=Ø6mm	ORDER NO. S=Ø6,35mm	ORDER NO. S=Ø8mm	ORDER NO. S=Ø12mm	ORDER NO. S=Ø12,7mm
•6	8	3	90°	46	10	715.060.11		915.060.11		
•6,35	8	3,18	90°	46	10		815.064.11			
9,5	12,7	4,75	90°	44,5	10	715.095.11	815.095.11	915.095.11		
12,7	12,7	6,35	90°	44,5	10	715.127.11	815.127.11	915.127.11		
16	12,7	8	90°	52,8	10			915.160.11		
16	12,7	8	90°	63,5	10				915.660.11	815.660.11
19	16	9,5	90°	55,5	10	715.190.11				
19	16	9,5	90°	63,5	10				915.690.11	815.690.11
31,7	19	15,88	90°	63,5	10			915.317.11	915.817.11	815.817.11
38	28,5	19	90°	63,5	10			915.380.11		
38	28,5	19	90°	70	10					815.880.11

• HWM



7/8/915B



In addition, CMT has versatile top bearing bits that allow for several template options of your choice (see series 715B-815B-915B).

TIPS: these bits perfectly chamfer at 45° angles (two tools in one).

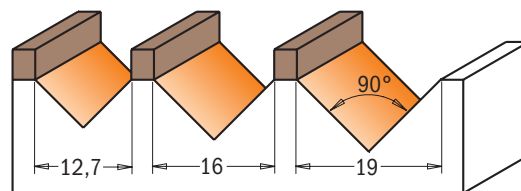

Drawing is 1:1 scale

D mm	I mm	I ₁ mm	A	L mm		ORDER NO. S=Ø6mm	ORDER NO. S=Ø6,35mm	ORDER NO. S=Ø8mm	ORDER NO. S=Ø12,7mm
12,7	12,7	6,35	90°	44,5	10		815.127.11B		
16	12,7	8	90°	52,8	10			915.160.11B	
19	16	9,5	90°	55,5	10	715.190.11B			
19	16	9,5	90°	63,5	10				815.690.11B

Spare parts

791.010.00	541.001.00	991.056.00
791.025.00	541.004.00	991.056.00
791.007.00	541.003.00	991.056.00
791.011.00	541.002.00	991.056.00

Spare parts: 990.005.00 M3x3mm STEI screw

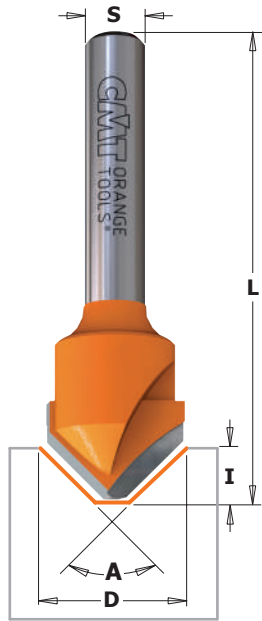

7/8/915

HW Z2 RH

ALUCOBOND® panels are an aluminium composite material that can be shaped using a very simple processing method. This technique referred to as the 'routing and folding' method which means paneling can be manipulated to form a variety of shapes and sizes. The advantages of this unique technique are:

- Low investment cost
- Simple fabrication technique
- Folding can be done on site, saving transportation costs
- Low-cost fabrication of shaped components, wall cladding, roof edgings, column cladding, flashings, etc.
- Flexibility in creating shapes
- Very cost effective
- Shapes are not limited by machine capacity.

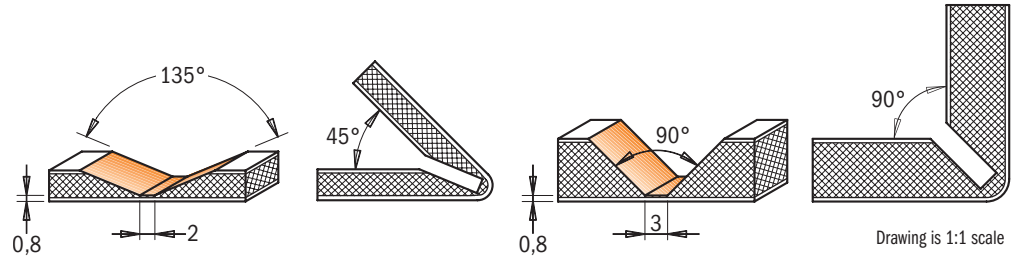

D mm	I mm	A	L mm		ORDER NO. S=Ø6mm	ORDER NO. S=Ø6,35mm	ORDER NO. S=Ø8mm		
18	7,4	90°	60	10	715.001.11	815.001.11	915.001.11		
18	3,3	135°	60	10	715.002.11	815.002.11	915.002.11		

Laser Point Bit



7/8/958

HWM HW Z1 Z2 Z3 RH

This bit crafts delicate grooves and incisions with laser precision. Make one-of-a-kind effects with 30° bevel edges in one single run. Equipped with three super sharp cutting edges, this perfectly balanced bit allows you to work with incredible accuracy with no risk of burning. Raise the bit and produce a delicate fine point incision, or work the whole 12,7mm diameter to render bold highlighted lettering. Super strong steel shank and micrograin carbide cutting edges guarantee long lasting performance.

7/858.002
• HWM

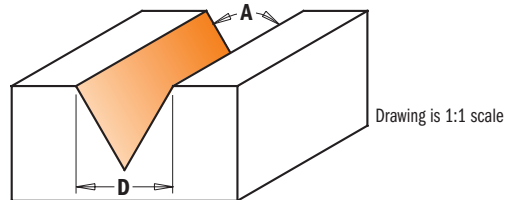

D mm	I mm	A	Z	L mm		ORDER NO. S=Ø6mm	ORDER NO. S=Ø6,35mm	ORDER NO. S=Ø8mm		ORDER NO. S=Ø12,7mm
•6	9	35°	1	50	10	758.002.11				
•6,35	9,5	35°	1	50,8	10		858.002.11			
12,7	11	60°	3	57,2	10	758.001.11	858.001.11	958.001.11		
12,7	11	60°	3	60,3	10					858.501.11
12,7	10	60°	2	50,8	10		858.003.11	958.003.11		

• HWM

V-Grooving & Signmaking Router Bits with indexable knives (90°)



665

These bits have been designed for signmaking and lettering. When the insert shows signs of wear, you can simply rotate it to exploit the other cutting edges. A locking screw secures the insert tightly for added safety and extreme cutting accuracy.

TECHNICAL DETAILS:

- Strength steel.
- 1 HW precision insert knife [Z1].

SAFETY TIPS



The **TW-006** Torque Screwdriver is recommended for the proper fastening of screws (see page 413).

CORRECT KNIFE POSITIONING

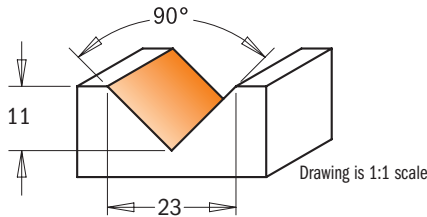
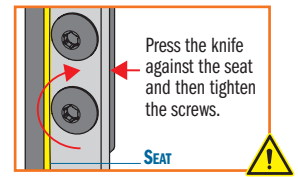

A	D mm	I mm	L mm		ORDER NO S=Ø6,35mm	ORDER NO S=Ø8mm
90°	23	11	60	10	665.201.11	665.200.11

Spare parts

790.280.00	990.093.00	991.073.00

Stepped Rebate Router Bit

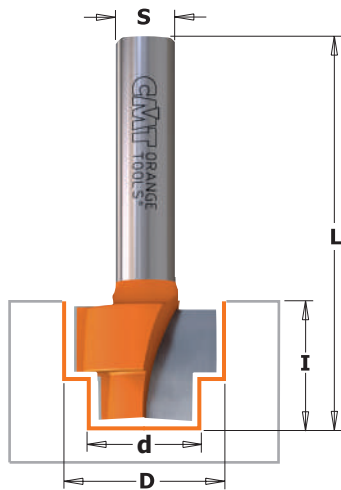

965



Router bit featuring 2 carbide-tipped cutting edges for producing double rebates on wood and wood composites. Designed for accepting library/bookcase shelving strips or for accommodating hardware into your window slots.

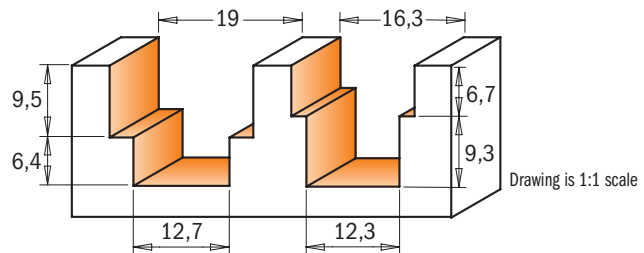

d mm	D mm	I mm	L mm		ORDER NO. S=Ø8mm
12,3	16,3	16	80	10	965.122.11
12,7	19	15,9	50,8	10	965.121.11

Chamfer Bits

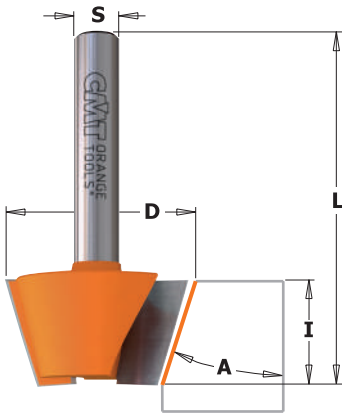

703/4/5 - 903/4/5



From a gently beveled edge to decorative chamfers in a variety of materials, CMT offers smooth results. Deeper cutting length means greater versatility on all bevel dimensions.

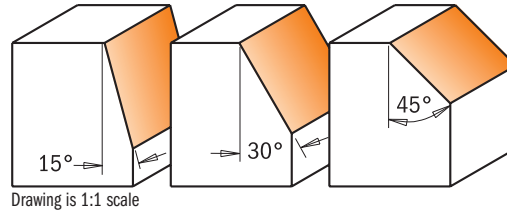

A	D mm	I mm	L mm		ORDER NO. S=Ø6mm	ORDER NO. S=Ø8mm
15°	24	14	46	10	703.240.11	903.240.11
30°	26	12,7	44,5	10	704.240.11	904.240.11
45°	25	8	41	10	705.240.11	905.240.11

Chamfer Bits with Insert Knives



Chamfer trim bits feature two replaceable knives fixed by special TORX® screws. The knives are sharpened on all sides and can be resharpened up to three times. For slight bevelled edges or decorative edgework in a variety of materials. Equipped with bearing guides with no need for counterprofiles. For use on portable routers.

SAFETY TIPS



The **TW-006** Torque Screwdriver is recommended for the proper fastening of screws (see page 413).

CORRECT KNIFE POSITIONING

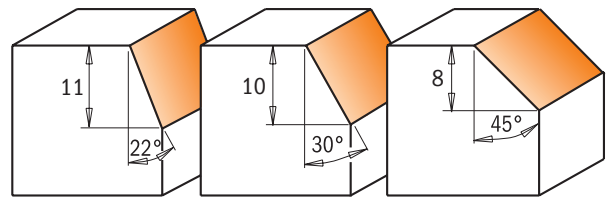
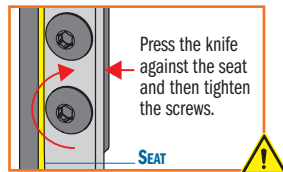

A	D mm	I mm	L mm		ORDER NO. S=Ø6mm	ORDER NO S=Ø6,35mm	ORDER NO S=Ø8mm	ORDER NO S=Ø12,7mm	Spare parts		
45°	29	8	52	10	658.047.11		658.045.11				
22°	25	11	65	10	659.024.11	659.023.11	659.022.11		790.120.00	990.075.00	
30°	28	10	66	10	659.032.11	659.031.11	659.030.11		790.120.00	990.075.00	791.006.00
45°	29	8	60	10	659.047.11	659.046.11	659.045.11		790.120.00	990.075.00	791.022.00
45°	29	8	68	10				659.646.11	790.120.00	990.075.00	791.022.00

Spare parts: **990.400.00** Ø3.2/Ø7mm shield for M3 screw
990.051.00 M3x6mm TCEI screw
991.062.00 2,5mm hex key
991.061.00 T15 TORX® key

Chamfer Bits

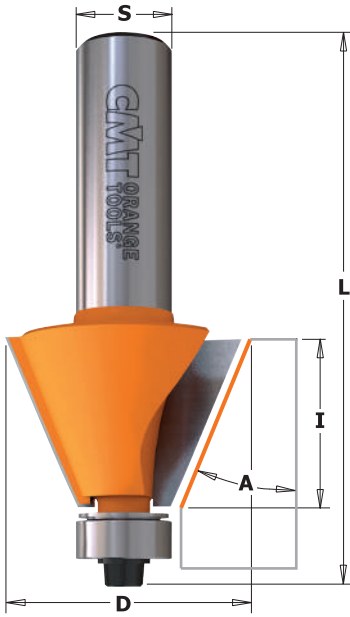

7/8/936 - 8/957

CMT chamfer bits can cut clean, accurate bevels and chamfers and are great for edge work or for making perfectly aligned multi-sided containers, boxes and other decorative projects. See illustration below for examples. Can be used for working larger scale projects such as beams and columns with excellent results.

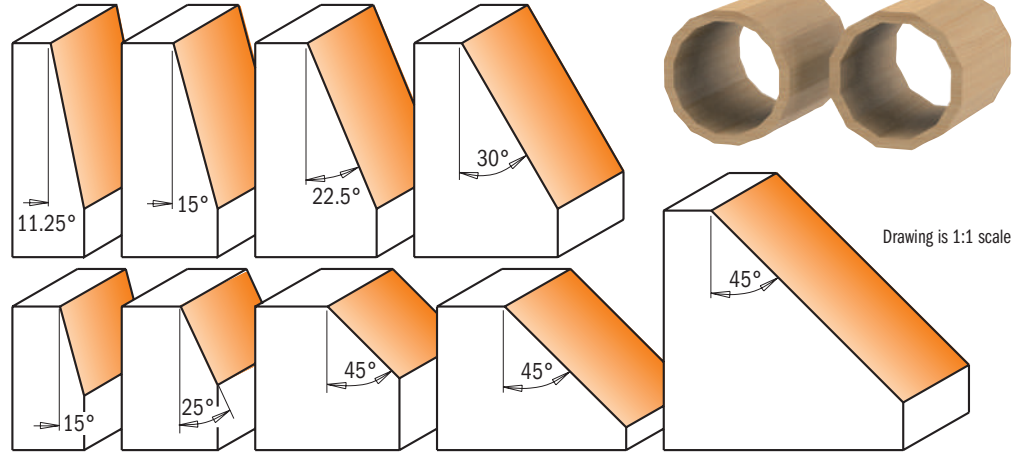

Drawing is 1:1 scale

A	D mm	I mm	L mm		ORDER NO. S=Ø6mm	ORDER NO. S=Ø6,35mm	ORDER NO. S=Ø8mm	ORDER NO. S=Ø12mm	ORDER NO. S=Ø12,7mm	Spare parts			
15°	19	11,5	54,9	10	736.130.11	836.130.11	936.130.11						
25°	22,2	10	54,9	10	736.190.11	836.190.11	936.190.11			990.423.00	791.003.00	990.058.00	991.057.00
45°	31,7	9,5	53	10	736.280.11	836.280.11	936.280.11			990.423.00	791.003.00	990.058.00	991.057.00
45°	45	18	60,2	10	736.420.11	836.420.11	936.420.11			990.423.00	791.003.00	990.058.00	991.057.00
45°	45	18	66,5	10				936.920.11	836.920.11	990.423.00	791.003.00	990.058.00	991.057.00
45°	65	26	76,7	5				936.950.11	836.950.11	990.423.00	791.003.00	990.058.00	991.057.00
11,25°	21,5	22	71,1	10				957.504.11	857.504.11	990.423.00	791.003.00	990.058.00	991.057.00
15°	24,5	22	71,1	10				957.503.11	857.503.11	990.423.00	791.003.00	990.058.00	991.057.00
22,5°	31	22	71,1	10				957.502.11	857.502.11	990.423.00	791.003.00	990.058.00	991.057.00
30°	38,5	22	71,1	10				957.501.11	857.501.11	990.423.00	791.003.00	990.058.00	991.057.00

SHOP TIPS: After resharpening, replace bearing 791.003.11 (Ø12,7mm) with undersized bearing 791.063.00 (Ø12,5mm)

Chamfer Set



836

This set includes 5 anti-kickback carbide-tipped bits to make angled cuts and polygonal projects easier and more accurate in the most popular angles.

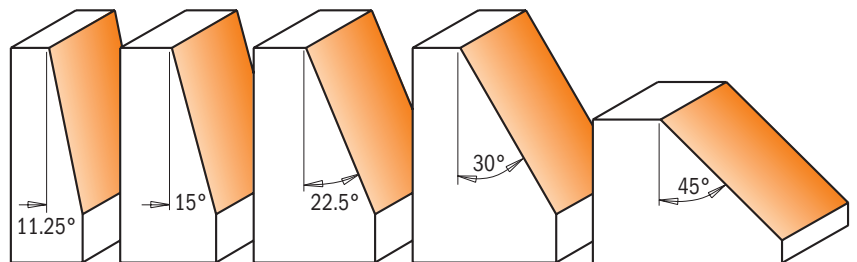

Drawing is 1:1 scale

DESCRIPTION		ORDER NO. S=Ø12,7mm
Chamfer Set	5	836.501.11

Round Nose Bits

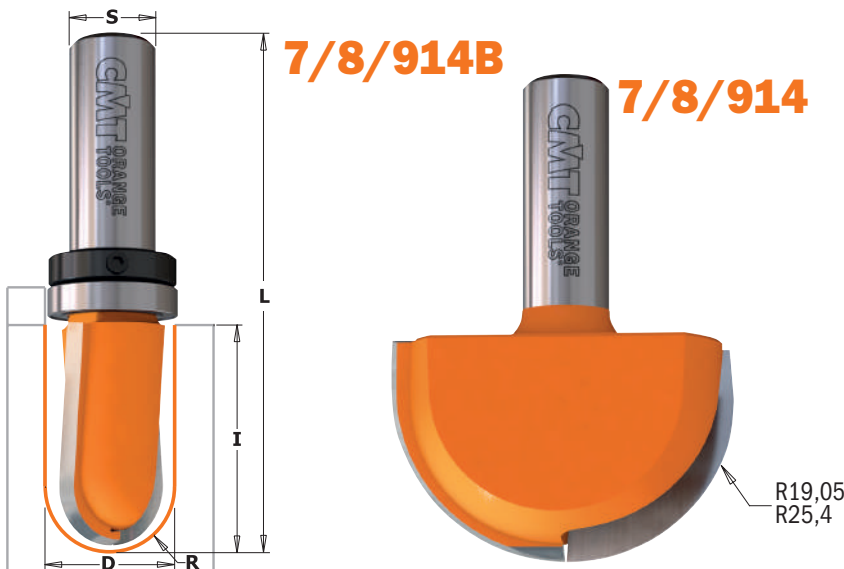

Personalize your doors, drawer fronts, panels or any surface with your own signature motif. CMT round nose bits in solid carbide featuring carbide tipped flutes let you create delicate and decorative accents in any wood or wood derivative.

SHOP TIPS: more than one pass is recommended when making cove edges. To prevent splintering, begin with a shallow initial pass and deepen gradually. Never use pieces shorter than 600mm.

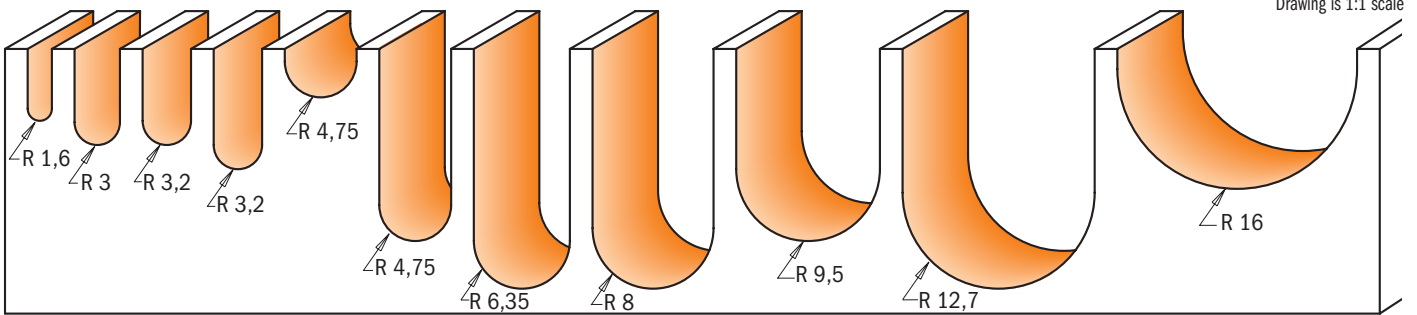

R mm	D mm	I mm	L mm	Z		ORDER NO. S=Ø6mm	ORDER NO. S=Ø6,35mm	ORDER NO. S=Ø8mm	ORDER NO. S=Ø12mm	ORDER NO. S=Ø12,7mm
•1,6	3,2	9,5	50,8	2	10	714.032.11	814.032.11	914.032.11		
•1,6	3,2	12,7	50,8	2	10		199.001.11			
•3	6	12,7	50,8	2	10	714.060.11		914.060.11		
•3	6	27	70	2	10	199.060.11				
•3,2	6,4	12,7	50,8	2	10		814.064.11			814.564.11
•3,2	6,4	25,4	63,5	2	10		199.008.11			
•3,2	6,4	15,9	63,5	2	10					
•4	8	32	80	2	10			199.081.11		
4,75	9,5	6,4	50,8	2	10	714.095.11	814.095.11	914.095.11		
4,75	9,5	25,4	66,7	2	10					814.595.11
•6	12	35	80	2	10				199.120.11	
6,35	12,7	9,5	50,8	2	10	714.127.11	814.127.11	914.127.11		
6,35	12,7	31,7	73	2	10				914.627.11	814.627.11
•6,35	12,7	31,7	76,2	2	10					199.505.11
8	15,8	9,5	50,8	2	10	714.160.11	814.160.11	914.160.11		
8	15,8	31,7	73	2	10					814.660.11
9,5	19	11,3	50,8	2	10	714.190.11	814.190.11	914.190.11		
9,5	19	25	63,5	2	10			914.191.11		
9,5	19	25	63,5	1+1	10			914.192.11		
9,5	19	31,7	73	2	10				914.690.11	814.690.11
11	22	25,4	63,5	2	10			914.221.11		814.721.11
11	22	25	63,5	1+1	10			914.222.11		
12,7	25,4	16	58,8	2	10			914.254.11		
12,7	25,4	31,7	73	2	10				914.754.11	814.754.11
16	31,7	18,5	58,8	2	10			914.817.11	814.817.11	
19,05	38,1	31,7	69,8	2	10			914.880.11	814.880.11	
25,4	50,8	31,7	69,8	2	10			914.990.11	814.990.11	
WITH TOP BEARING										
6,35	12,7	9,5	50,8	2	10		814.127.11B			
8	15,8	9,5	50,8	2	10		814.160.11B			
8	15,8	9,5	50,8	2	10			914.160.11B		
9,5	19	11,3	50,8	2	10	714.190.11B				
9,5	19	11,3	50,8	2	10		814.190.11B			
9,5	19	31,7	73	2	10					814.690.11B



Spare parts

791.010.00	541.001.00
791.009.00	541.001.00
791.025.00	541.004.00
791.007.00	541.003.00
791.004.00	541.001.00
791.011.00	541.002.00

Spare parts: 990.005.00 M3x3mm TSEI screw

991.056.00 1,5mm hex key

• HWM

Ball End Bit

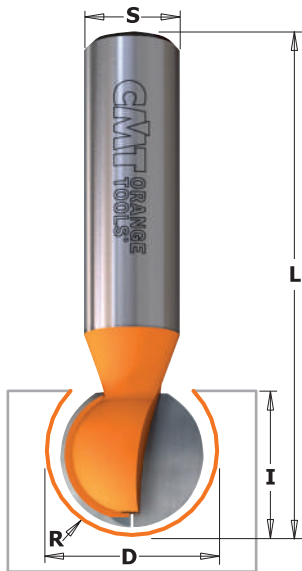

8/968

Cut channels for pipes or cables in one single pass using CMT's ball end bits. Reduce the stress on the bits by cutting a first groove with a straight bit.

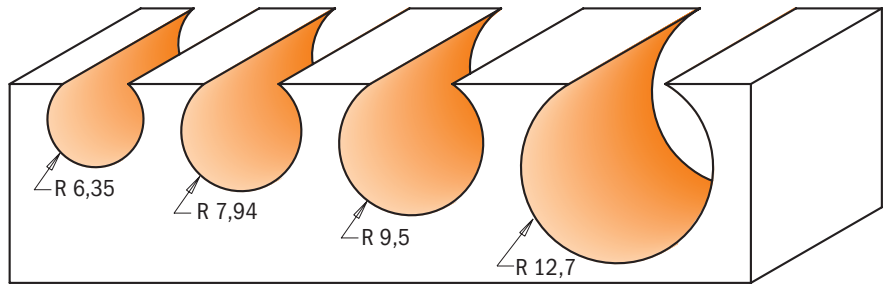

Drawing is 1:1 scale

R mm	D mm	I mm	L mm		ORDER NO. S=Ø8mm	ORDER NO. S=Ø12mm	ORDER NO. S=Ø12,7mm
6,35	12,7	11	57,15	10	968.127.11		868.627.11
7,94	15,88	14,2	60,3	10	968.158.11		868.658.11
9,52	19,05	17,4	63,5	10	968.190.11		868.690.11
12,7	25,4	23,5	70	10		968.754.11	868.754.11

Round Nose Set



814

Each of these sets include 3 of the most widely used CMT Round Nose bits. These solid carbide or carbide tipped bits are perfect for sign making, engraving, or adding flutes and veins to doors or drawer fronts. Available in 6,35mm and 12,7mm shanks.

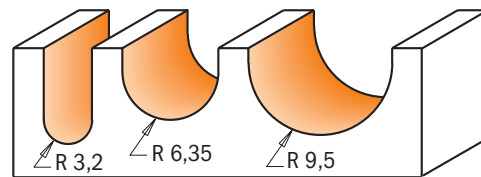

814.001.11

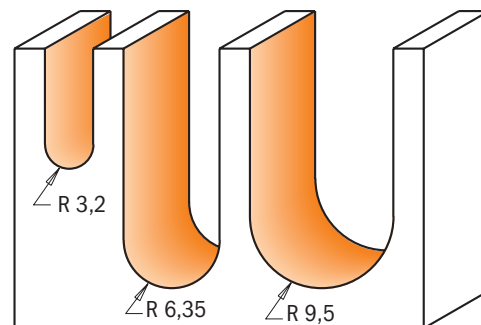

814.501.11

Drawing is 1:1 scale

DESCRIPTION		ORDER NO. S=Ø6,35mm	ORDER NO. S=Ø12,7mm
Round Nose Set	5	814.001.11	814.501.11

Cove Bits

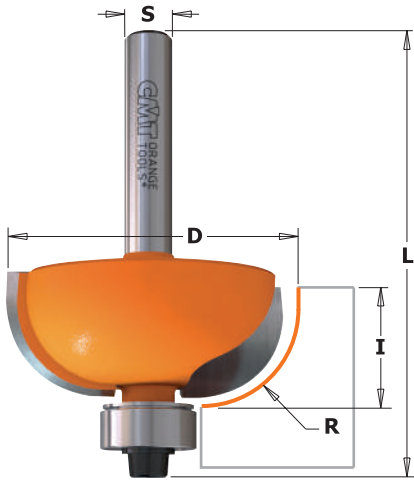

7/8/937

Make simple or elegant furniture, doors and drawer fronts by adding a final touch with CMT cove bits.

TIPS: rounded edges provide a very refined and elegant look.

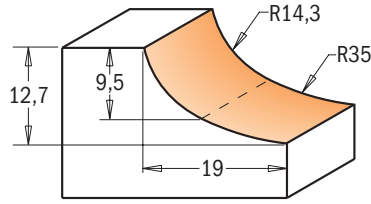

8/937.955.11

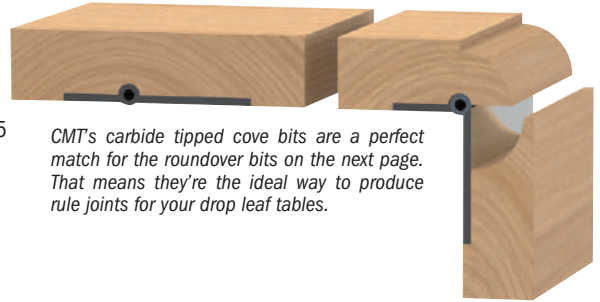

CMT's carbide tipped cove bits are a perfect match for the roundover bits on the next page. That means they're the ideal way to produce rule joints for your drop leaf tables.

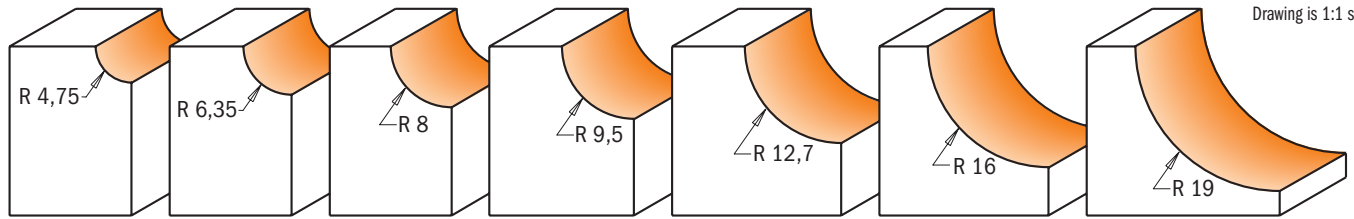

Drawing is 1:1 scale

R mm	D mm	I mm	L mm		ORDER NO. S=Ø6mm	ORDER NO. S=Ø6,35mm	ORDER NO. S=Ø8mm	ORDER NO. S=Ø12mm	ORDER NO. S=Ø12,7mm	Spare parts			
4,75	22,2	12,7	54,9	10	737.190.11	837.190.11	937.190.11						
4,75	22,2	12,7	61,2	10				937.690.11	837.690.11	990.423.00	791.003.00	990.058.00	991.057.00
6,35	25,4	12,7	54,9	10	737.222.11	837.222.11	937.222.11			990.423.00	791.003.00	990.058.00	991.057.00
6,35	25,4	12,7	61,2	10				937.722.11	837.722.11	990.423.00	791.003.00	990.058.00	991.057.00
8	28,7	12,7	54,2	10	737.254.11	837.254.11	937.254.11			990.423.00	791.003.00	990.058.00	991.057.00
8	28,7	12,7	60,5	10				937.754.11	837.754.11	990.423.00	791.003.00	990.058.00	991.057.00
9,5	31,7	12,7	54,2	10	737.286.11	837.286.11	937.286.11			990.423.00	791.003.00	990.058.00	991.057.00
9,5	31,7	12,7	60,5	10				937.786.11	837.786.11	990.423.00	791.003.00	990.058.00	991.057.00
12,7	38,1	15,5	57,7	10	737.350.11	837.350.11	937.350.11			990.423.00	791.003.00	990.058.00	991.057.00
12,7	38,1	15,5	64	10				937.850.11	837.850.11	990.423.00	791.003.00	990.058.00	991.057.00
16	44,5	18,5	67	10				937.950.11	837.950.11	990.423.00	791.003.00	990.058.00	991.057.00
19	50,8	22,2	70,7	10				937.951.11	837.951.11	990.423.00	791.003.00	990.058.00	991.057.00
14,3-35	50,8	12,7	61,2	10				937.955.11	837.955.11	990.423.00	791.003.00	990.058.00	991.057.00

Cove Bit Set



837

See simple furniture, doors and drawer fronts transform into elegant pieces by giving them a final touch with a CMT Cove Bit.

Available with 6,35mm-12,7mm shank and cove radii from 6,35mm - 9,5mm - 12,7mm.

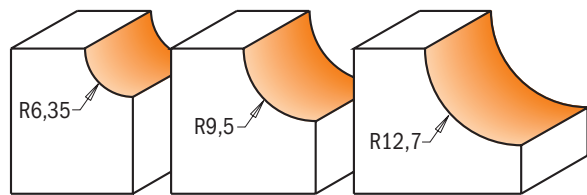

Drawing is 1:1 scale

DESCRIPTION		ORDER NO. S=Ø6,35mm	ORDER NO. S=Ø12,7mm
Cove Bit Set	5	837.001.11	837.501.11

Cavetto Edge Mould Bits



7/8/963 - 7/8/964

The cavetto bit cuts beautiful, traditional profiles, but you may also use just a portion of the bit to cut a more simple and cleaner cove edge.

SAFETY TIPS: poor assembly may lead to unscrewing and loss of the bearing during operation.

SHOP TIPS: after resharpening, replace bearing as follow:
791.002.00 (Ø9,5mm) with undersized bearing **791.062.00** (Ø9,3mm)
791.003.00 (Ø12,7mm) with undersized bearing **791.063.00** (Ø12,5mm)

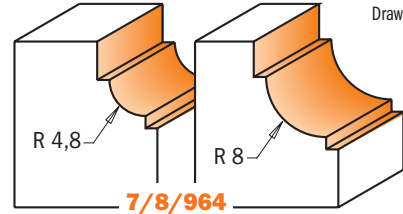
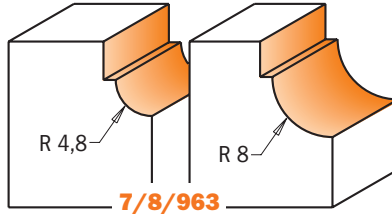
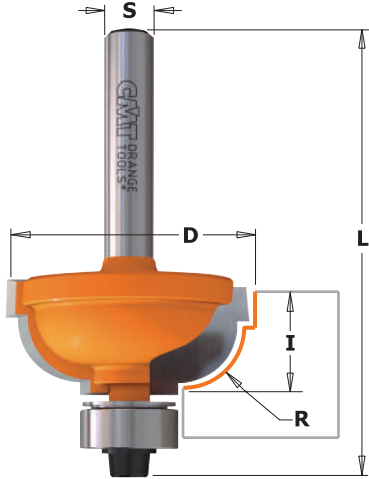

Drawing is 1:1 scale

R mm	D mm	I mm	L mm		ORDER NO. S=Ø6mm	ORDER NO. S=Ø6,35mm	ORDER NO. S=Ø8mm	ORDER NO. S=Ø12mm	ORDER NO. S=Ø12,7mm
4,8	25,4	11,5	54,6	10	763.048.11	863.048.11	963.048.11		
4,8	25,4	11,5	60,9	10				963.548.11	863.548.11
8	31,7	14,3	56,9	10	763.080.11	863.080.11	963.080.11		
8	31,7	14,3	63	10				963.580.11	863.580.11
4,8	25,4	11,5	52,8	10	764.048.11	864.048.11	964.048.11		
4,8	25,4	11,5	59,1	10				964.548.11	864.548.11
8	31,7	14,3	55,1	10	764.080.11	864.080.11	964.080.11		
8	31,7	14,3	61	10				964.580.11	864.580.11

Spare parts

990.423.00	791.003.00	990.058.00	991.057.00
990.423.00	791.003.00	990.058.00	991.057.00
990.423.00	791.003.00	990.058.00	991.057.00
990.423.00	791.003.00	990.058.00	991.057.00
990.422.00	791.002.00	990.058.00	991.057.00
990.422.00	791.002.00	990.058.00	991.057.00
990.422.00	791.002.00	990.058.00	991.057.00
990.422.00	791.002.00	990.058.00	991.057.00

Ovolo Bits

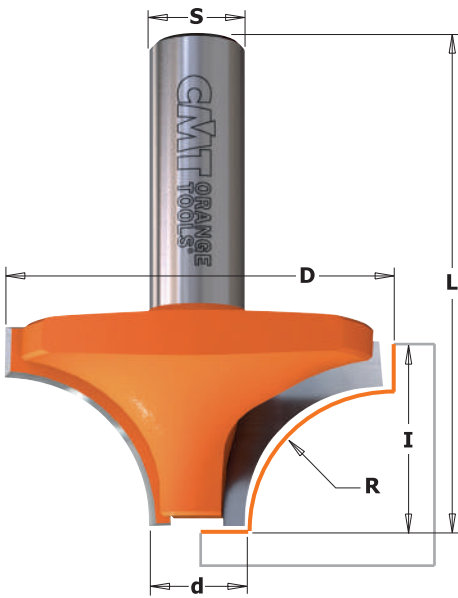

7/8/927



The perfect bit for furniture makers, the CMT ovolo allows you to make beautiful beadwork, edgework and veins as well as a wide variety of single and double bead profiles and roundovers.

SAFETY TIPS: pay particular attention to never rush the job when using a large profile bit. Mill pieces with a fence mounted on the work table to ensure maximum protection.

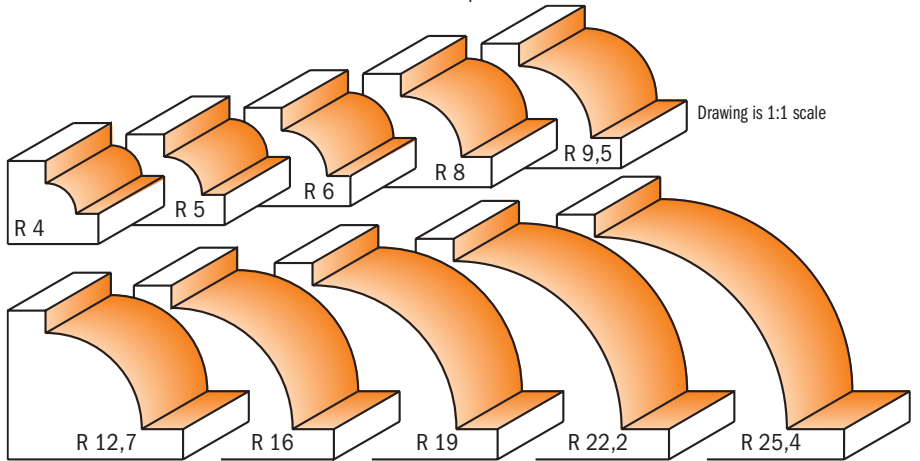

Drawing is 1:1 scale

R mm	d mm	D mm	I mm	L mm		ORDER NO. S=Ø6mm	ORDER NO. S=Ø6,35mm	ORDER NO. S=Ø8mm	ORDER NO. S=Ø12mm	ORDER NO. S=Ø12,7mm
4	11	19	12	43,8	10	727.040.11		927.040.11		
5	11	21	12	43,8	10	727.050.11	827.050.11	927.050.11		
6	11	23	12	43,8	10	727.060.11	827.060.11	927.060.11		
6	11	23	12	50,1	10					827.560.11
8	12,7	28,7	12,7	44,5	10	727.080.11		927.080.11		
9,5	12,7	31,7	15,8	47,6	10	727.095.11	827.095.11	927.095.11		
9,5	12,7	31,7	15,8	54	10				927.595.11	827.595.11
12,7	12,7	38,1	19	50,8	10		827.127.11			
12,7	12,7	38,1	19	57,1	10				927.627.11	827.627.11
16	12,7	44,5	22,2	60,3	10				927.660.11	827.660.11
19	12,7	50,8	25,4	63,5	10				927.690.11	827.690.11
22,2	12,7	57,1	28,5	66,6	5				927.722.11	827.722.11
25,4	12,7	63,5	33,3	71,4	5				927.754.11	827.754.11



7/8/939

If you want to create a delicate inset at the base of the cut of a roundover profile, simply switch the bearing normally used for making profiles 7/8/938 (listed on the following page) to the undersized one listed below (791.002.00).

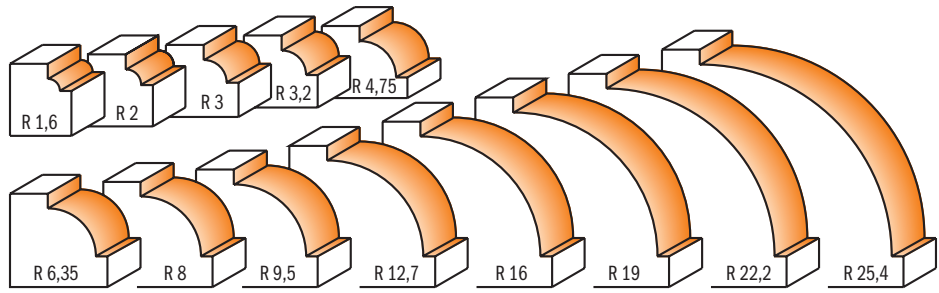
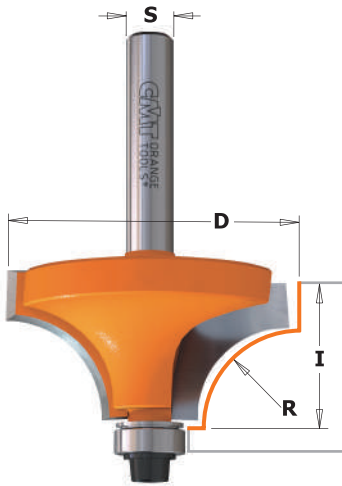

Drawing is 1:1 scale

R mm	D mm	I mm		ORDER NO. S=Ø6mm	ORDER NO. S=Ø6,35mm	ORDER NO. S=Ø8mm	ORDER NO. S=Ø12mm	ORDER NO. S=Ø12,7mm	Spare parts			
1,6	15,9	12,7	10	739.160.11	839.160.11	939.160.11			990.422.00	791.002.00	990.058.00	991.057.00
2	16,7	12,7	10			939.167.11			990.422.00	791.002.00	990.058.00	991.057.00
3	18,7	12,7	10			939.187.11			990.422.00	791.002.00	990.058.00	991.057.00
3,2	19,1	12,7	10	739.190.11	839.190.11	939.190.11			990.422.00	791.002.00	990.058.00	991.057.00
4,75	22,2	12,7	10	739.222.11	839.222.11	939.222.11			990.422.00	791.002.00	990.058.00	991.057.00
6,35	25,4	12,7	10	739.254.11	839.254.11	939.254.11	939.754.11	839.754.11	990.422.00	791.002.00	990.058.00	991.057.00
8	28,6	12,7	10	739.285.11	839.285.11	939.285.11			990.422.00	791.002.00	990.058.00	991.057.00
9,5	31,7	16	10	739.317.11	839.317.11	939.317.11	939.817.11	839.817.11	990.422.00	791.002.00	990.058.00	991.057.00
12,7	38,1	19	10	739.380.11	839.380.11	939.380.11	939.880.11	839.880.11	990.422.00	791.002.00	990.058.00	991.057.00
16	44,5	22	10		839.445.11	939.445.11	939.945.11	839.945.11	990.422.00	791.002.00	990.058.00	991.057.00
19	50,8	25,4	10				939.990.11	839.990.11	990.422.00	791.002.00	990.058.00	991.057.00
22,2	57,1	28,5	5				939.991.11	839.991.11	990.422.00	791.002.00	990.058.00	991.057.00
25,4	63,5	33,3	5				939.992.11*	839.992.11*	990.422.00	791.002.00	990.058.00	991.057.00

*For use on router tables only.



Roundover Bits with Insert Knives

661.11

Roundover bits with two replaceable knives fixed by special TORX® screws. The blades are profiled on 2 sides and increase the efficiency of your work with laminates and chipboard, as well as hard and soft woods. For use on portable routers.

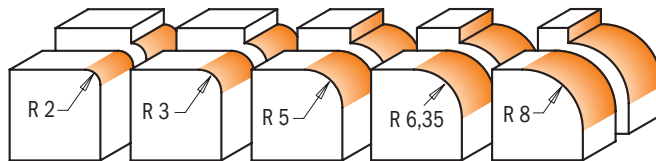

Drawing is 1:1 scale



661.41

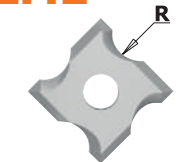

Standard
R=3mm 790.030.04

Optional
R=1mm 790.010.04
R=1,5mm 790.015.04
R=2mm 790.020.04

SAFETY TIPS



The **TW-006** Torque Screwdriver is recommended for the proper fastening of screws (see page 413).

CORRECT KNIFE POSITIONING

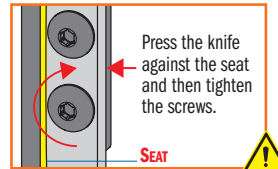

R mm	D mm	I mm	L mm		ORDER NO. S=Ø6,35mm	ORDER NO. S=Ø8mm	ORDER NO S=Ø12,7mm	Spare parts					
2	27		57,5	10	661.021.41	661.020.41		790.020.04	990.078.00	991.061.00	791.003.00		
3	27		57,5	10	661.031.41	661.030.41		790.030.04	990.078.00	991.061.00	791.003.00		
5	28,8	19,5	64	10	661.051.11	661.050.11		790.050.00	990.076.00	991.061.00	791.007.00		
6,35	28,5	24	67	10	661.064.11	661.063.11		790.064.00	990.076.00	991.061.00	791.006.00		
8	31,8	24	67	10		661.080.11		790.080.00	990.075.00	991.061.00	791.006.00		
8	31,8	24	77	10			661.581.11	790.080.00	990.075.00	991.061.00	791.006.00		

Spare parts: 990.400.00 M3 shield 990.410.00 M4 shield 990.423.00 Shield for 12,7mm bearing
 990.051.00 M3x6mm TCEI screw 990.052.00 M4x6mm TCEI screw 990.058.00 1/8"x3/8"x1/2" TCEI screw
 991.062.00 2,5mm hex key 991.067.00 3mm hex key 991.057.00 3/32" hex key

Roundover Bits



7/8/938

All CMT roundover bits provide a wide variety of profiles to create beautiful decorative edgework on furniture or boats. Lower the bit to expose the straight part of the cutting edge in this way you can apply a decorative edge to tables, shelves and beams.

SHOP TIPS: use the 1.6mm radius roundover bit for finishing laminates. A simple height adjustment helps save time on finishing.

SAFETY TIPS: use caution when working with large diameter bits and make more than one pass to gradually remove stock.

SHOP TIPS: after resharpening, replace bearing 791.003.11 (Ø12,7mm) with undersized bearing 791.063.00 (Ø12,5mm)

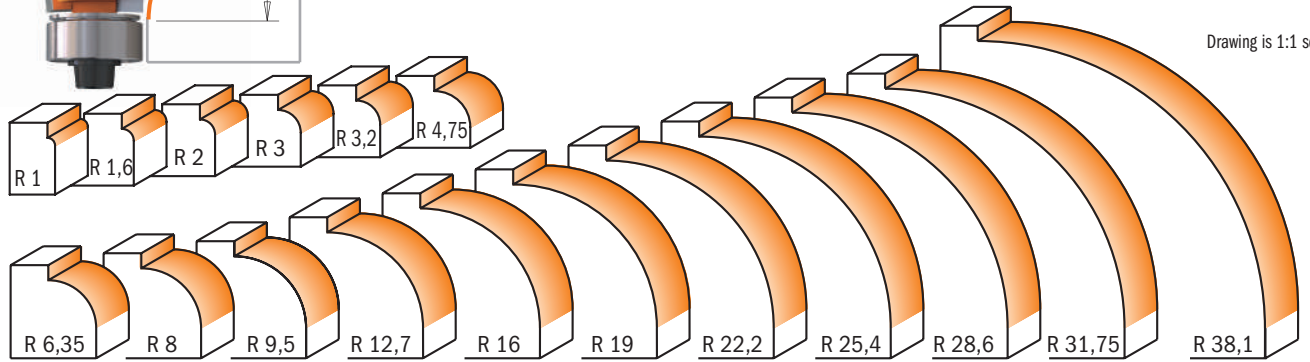
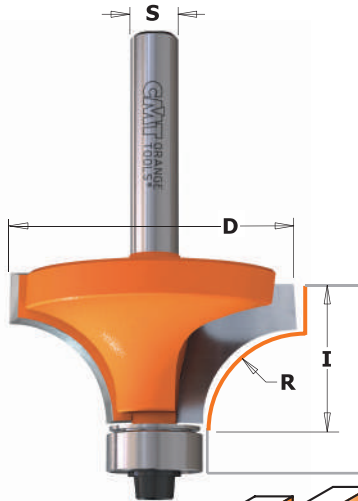

Drawing is 1:1 scale

R mm	D mm	I mm	Box	ORDER NO. S=Ø6mm	ORDER NO. S=Ø6,35mm	ORDER NO. S=Ø8mm	ORDER NO. S=Ø12mm	ORDER NO. S=Ø12,7mm	Spare parts
1	14,7	10	10		838.147.11	938.147.11			990.422.00 791.044.00 990.058.00 991.057.00
1,6	15,9	12,7	10	738.160.11	838.160.11	938.160.11			990.423.00 791.003.00 990.058.00 991.057.00
2	16,7	12,7	10	738.167.11°		938.167.11°			990.422.00 791.044.00 990.058.00 991.057.00
2	16,7	12,7	10		838.167.11				990.423.00 791.003.00 990.058.00 991.057.00
3	18,7	12,7	10	738.187.11°		938.187.11°			990.422.00 791.044.00 990.058.00 991.057.00
3	18,7	12,7	10		838.187.11				990.423.00 791.003.00 990.058.00 991.057.00
3,2	19,1	12,7	10	738.190.11	838.190.11	938.190.11			990.423.00 791.003.00 990.058.00 991.057.00
4,75	22,2	12,7	10	738.222.11	838.222.11	938.222.11			990.423.00 791.003.00 990.058.00 991.057.00
6,35	25,4	12,7	10	738.254.11	838.254.11	938.254.11	938.754.11	838.754.11	990.423.00 791.003.00 990.058.00 991.057.00
8	28,6	12,7	10	738.285.11	838.285.11	938.285.11			990.423.00 791.003.00 990.058.00 991.057.00
9,5	31,7	16	10	738.317.11	838.317.11	938.317.11	938.817.11	838.817.11	990.423.00 791.003.00 990.058.00 991.057.00
12,7	38,1	19	10	738.380.11	838.380.11	938.380.11	938.880.11	838.880.11	990.423.00 791.003.00 990.058.00 991.057.00
16	44,5	22	10		838.445.11	938.445.11	938.945.11	838.945.11	990.423.00 791.003.00 990.058.00 991.057.00
19	50,8	25,4	10				938.990.11	838.990.11	990.423.00 791.003.00 990.058.00 991.057.00
22,2	57,1	28,5	5				938.991.11	838.991.11	990.423.00 791.003.00 990.058.00 991.057.00
25,4	63,5	33,3	5				938.992.11*	838.992.11*	990.423.00 791.003.00 990.058.00 991.057.00
28,6	76,2	38,1	5				938.993.11*	838.993.11*	990.425.00 791.004.00 990.058.00 991.057.00
31,75	82,5	44,4	5				938.994.11*	838.994.11*	990.425.00 791.004.00 990.058.00 991.057.00
38,1	88,9	44,4	5				938.996.11*	838.996.11*	990.423.00 791.003.00 990.058.00 991.057.00

Spare parts: 541.550.00 1,6mm spacers (8/938.993.11 and 8/938.994.11)

*For use on router tables only

°791.044.00 DELRIN® Bearing



Roundover Set

838

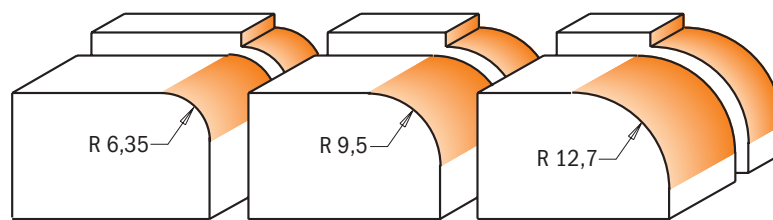

Drawing is 1:1 scale

DESCRIPTION	Box	ORDER NO. S=Ø6,35mm	ORDER NO. S=Ø12,7mm
Roundover set	5	838.001.11	838.501.11

CMT's roundover sets give you the maximum flexibility for all of your projects by putting the most requested diameters in one package. Available in 12,7mm and 6,35mm shanks. Roundover radii are 6,35mm, 9,5mm and 12,7mm. These versatile bits are always in demand - the simple clean lines of a smooth roundover edge can be used in a wide variety of applications from picture frames to table and counter tops.

DP - Corner Rounding Router Bits for composites and laminates

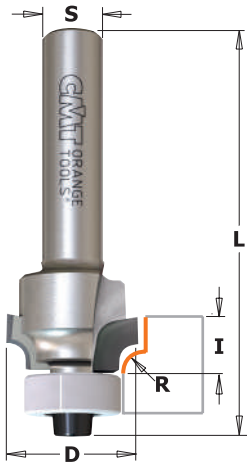

938 XTREME

These new super duty DP (polycrystalline diamond) bits represent the ultimate in the extensive line of CMT rounding over bits. These bits save you both time and money, as they last 40 times longer than conventional bits. Work a wide variety of tough, abrasive materials including composites, particleboard, MDF (both raw or with melamine), veneer and hardwoods.

Excellent for Corner Rounding:

- Aluminum
- Aluminum Composites
- Aluminum Composite Material (ACM)
- Composites
- Composite Panels
- Custom Composite Materials
- Fiberglass
- Fiberglass PCB Board
- Fiberglass Reinforced Composites
- Fiber-Reinforced Urethane
- Fiber-Reinforced Structural Foam Floors
- Hard and Soft Wood
- Lightweight Composites
- MDF
- Plastic

Benefits of Diamond Technology

- Harder cutting edge provides higher resistance to wear
- Cut thousands of meters more than carbide without changing tool, saving setup time
- Optimized machine tool efficiency
- Quality of finish is often significantly improved

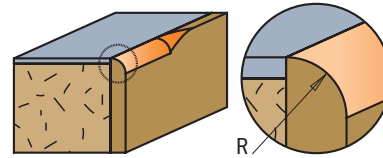

R mm	D mm	I mm		ORDER NO. S=Ø8mm
2	16,7	8	10	938.167.61
3	18,7	8	10	938.187.61

Spare parts

990.422.00	791.044.00	990.058.00	991.057.00
990.422.00	791.044.00	990.058.00	991.057.00

791.044.00 DELRIN® bearing

Decorative Ogee Bits

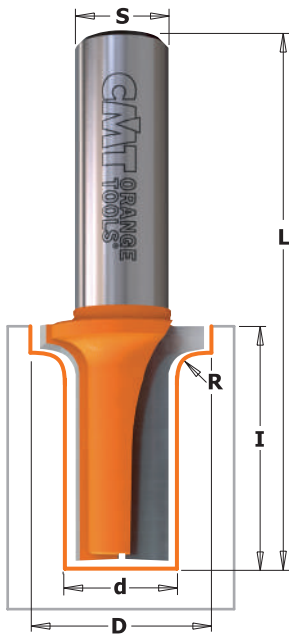

8/965.905



8/965.903
8/965.904

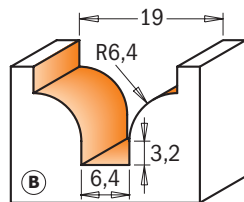

8/965.9



Enhance your doors and drawer fronts and leave your visitors amazed! The cutting edges on these ogee bits are carbide-tipped for effective, smooth and eye-catching work.

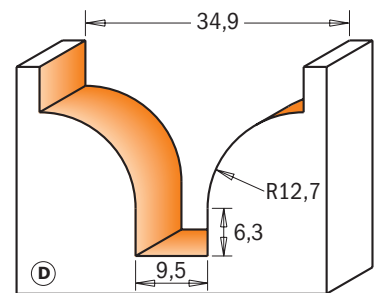
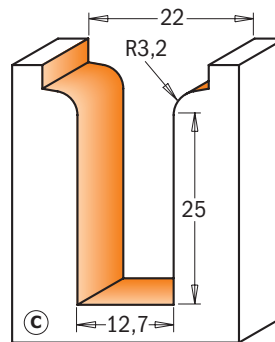

Drawing is 1:1 scale

D mm	d mm	R mm	I mm	L mm	PROFILE		ORDER NO. S=Ø12mm	ORDER NO. S=Ø12,7mm
19	6,4	6,4	13	51	B	10	965.903.11	865.903.11
22	12,7	3,2	31,7	69,8	C	10	965.905.11	865.905.11
34,9	9,5	12,7	25	65,5	D	10	965.904.11	865.904.11

Decorative Beading Bits

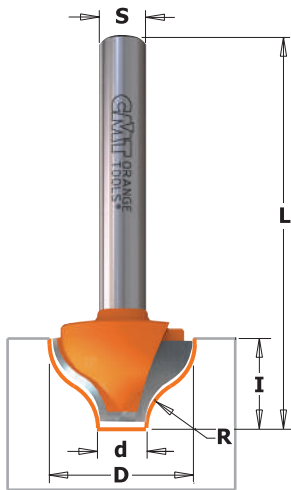

7/8/965

This new CMT bit produces a classic single or double-edged bead. Ideal for creating a marked decorative effect on panel, door and drawer work.

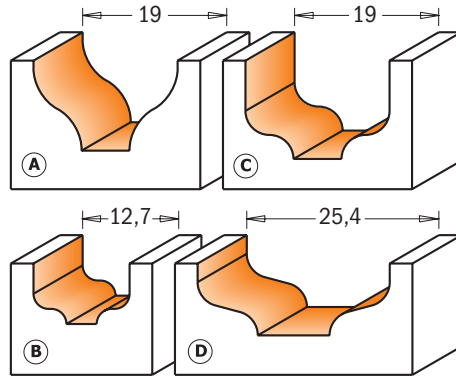

Drawing is 1:1 scale

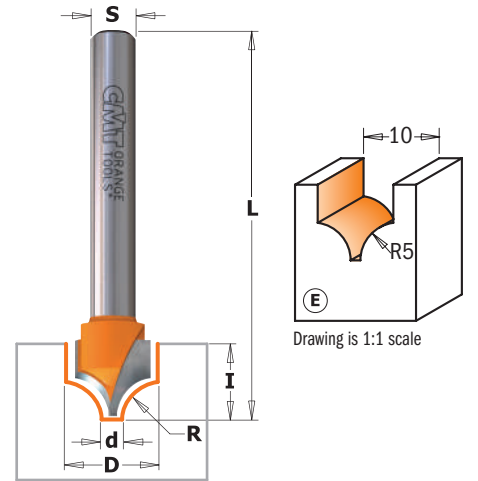

Drawing is 1:1 scale

D mm	d mm	R mm	I mm	L mm	PROFILE		ORDER NO. S=Ø6mm	ORDER NO. S=Ø6,35mm	ORDER NO. S=Ø8mm	ORDER NO. S=Ø12mm	ORDER NO. S=Ø12,7mm
19	6,35	6,4	11	50,8	A	10	765.001.11	865.001.11	965.001.11	965.501.11	865.501.11
12,7	4	2	8	51	B	10		865.002.11	965.002.11		
19	6,35	3,2	13	68	C	10				965.503.11	865.503.11
25,4	9,5	3,2	9,5	49	D	10				965.504.11	865.504.11
10	1,3	5	10	50	E	10	765.402.11	865.402.11	965.402.11		

Classical Bead Bits

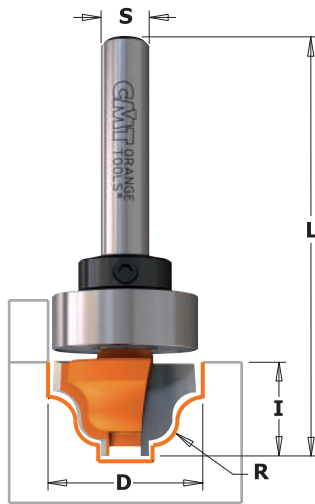

7/8/965B

This bit equipped with a bearing fixed on the shank gives you even more decorative possibilities such as inlays and groove work on furniture panels, vitrines, and drawer fronts. A wide flat bottom cut and positioning just above the wood surface, lets you see the results immediately.

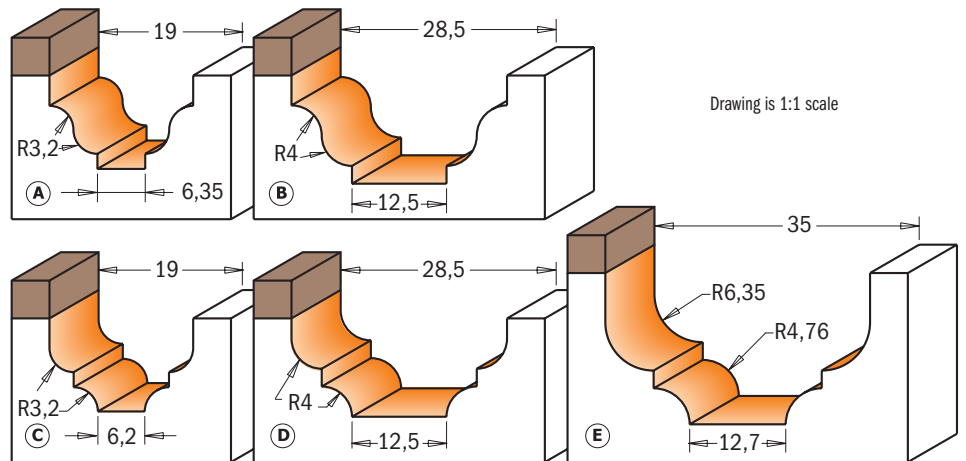

Drawing is 1:1 scale

D mm	R mm	I mm	L mm	PROFILE		ORDER NO S=Ø6mm	ORDER NO S=Ø6,35mm	ORDER NO S=Ø8mm	ORDER NO S=Ø12mm	ORDER NO S=Ø12,7mm	Spare parts		
19	3,2	12,3	54	A	10	765.201.11B							
19	3,2	12,3	54	A	10		865.201.11B				791.007.00	541.003.00	991.056.00
28,6	4	14,3	58,8	B	10			965.202.11B			791.004.00	541.001.00	991.056.00
28,6	4	14,3	58,8	B	10				965.702.11B		791.027.00	541.002.00	991.056.00
28,6	4	14,3	58,8	B	10					865.702.11B	791.027.00	541.005.00	991.056.00
19	3,2	12,3	54	C	10	765.301.11B					791.027.00	541.002.00	991.056.00
19	3,2	12,3	54	C	10		865.301.11B				791.007.00	541.003.00	991.056.00
28,6	4	13,3	58	D	10			965.302.11B		865.802.11B	791.004.00	541.001.00	991.056.00
28,6	4	13,3	58	D	10				965.802.11B		791.027.00	541.002.00	991.056.00
34,9	4,76 - 6,35	18,5	66,1	E	10			965.303.11B			791.027.00	541.005.00	991.056.00
34,9	4,76 - 6,35	18,5	66,1	E	10					865.803.11B	791.031.00	541.004.00	991.056.00
											791.029.00	541.002.00	991.056.00

Spare parts: 990.005.00 M3x3mm TSEI screw

Plunge Ogee Bits



7/8/948

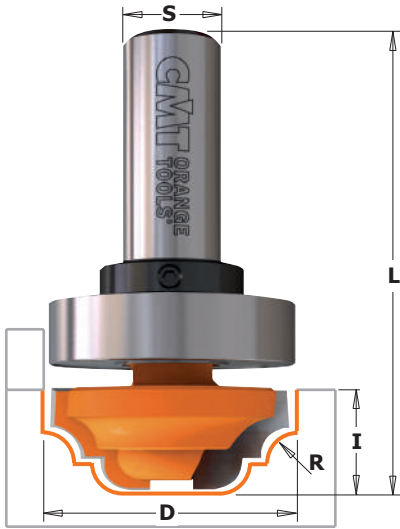

7/8/948B

You will never run out of ideas with this creative bit. Add a classic touch to any edge or highlight door fronts and panels with decorative layered effects.

SHOP TIPS: for even more options, try the CMT plunge ogee with bearing for precision profiling. The bearing guarantees excellent decorative edgework.

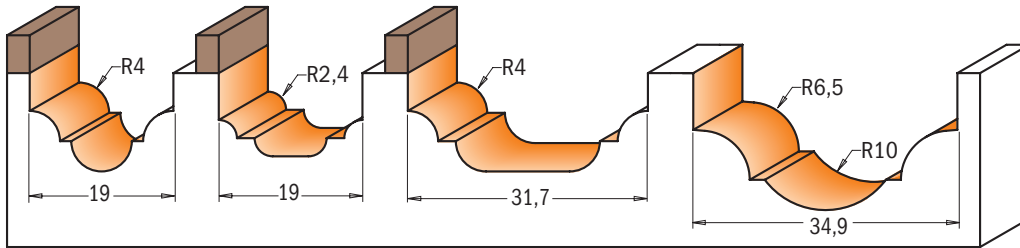

Drawing is 1:1 scale

D mm	R mm	I mm	L mm		ORDER NO S=Ø6mm	ORDER NO S=Ø6,35mm	ORDER NO S=Ø8mm	ORDER NO S=Ø12mm	ORDER NO S=Ø12,7mm
19	4	13	51,1	10	748.190.11	848.190.11	948.190.11		
19	2,4	12	53	10	748.191.11	848.191.11	948.191.11		
31,7	4	13	58	10			948.317.11	948.817.11	848.817.11
34,9	6,5-10	18	68	10				948.850.11	848.850.11
WITH TOP BEARING									
19	4	13	51,1	10	748.190.11B				
19	4	13	51,1	10		848.190.11B			
19	2,4	12	53	10	748.191.11B				
19	2,4	12	53	10		848.191.11B			
31,7	4	13	58	10			948.317.11B		
31,7	4	13	58	10				948.817.11B	
31,7	4	13	58	10					848.817.11B

Spare parts

791.007.00	541.003.00	991.056.00
791.004.00	541.001.00	991.056.00
791.007.00	541.003.00	991.056.00
791.004.00	541.001.00	991.056.00
791.015.00	541.002.00	991.056.00
791.015.00	541.005.00	991.056.00
791.015.00	541.002.00	991.056.00

Spare parts: 990.005.00 M3x3mm TSEI screw

Decorative Ogee Bits

7/8/965.1

This new CMT bit produces a classic single or double edged bead. Ideal for creating a marked decorative effect on panel, door and drawer work.

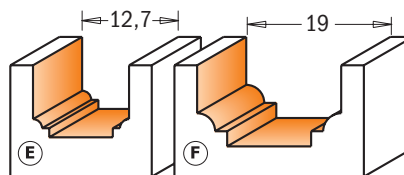
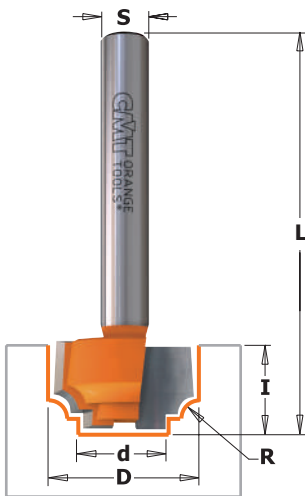

Drawing is 1:1 scale

D mm	d mm	R mm	I mm	L mm	PROFILE		ORDER NO. S=Ø6mm	ORDER NO. S=Ø6,35mm	ORDER NO. S=Ø8mm
12,7	8,4	1,2	12,7	50,8	E	10	765.101.11	865.101.11	965.101.11
19	11,1	2,4	11	50,8	F	10	765.102.11	865.102.11	965.102.11

Roman Ogee Bits

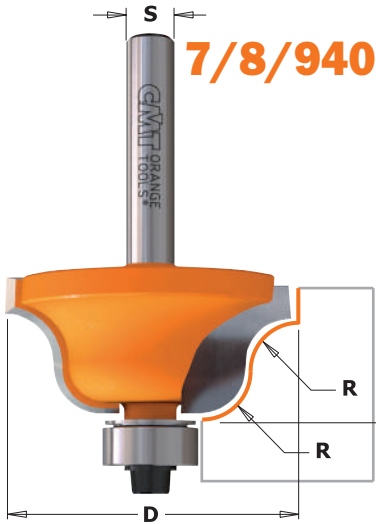

The roman ogee may be the most popular edge treatment in woodworking, and it is certainly one of the most beautiful and varied in classic design.

SHOP TIPS: given the complexity of this kind of machining, for best results, multiple passes are recommended.

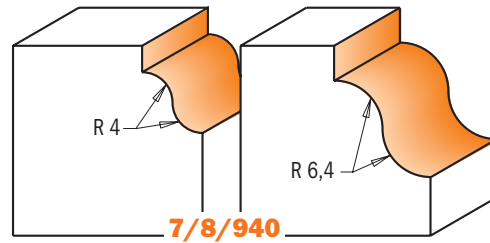

Drawing is 1:1 scale

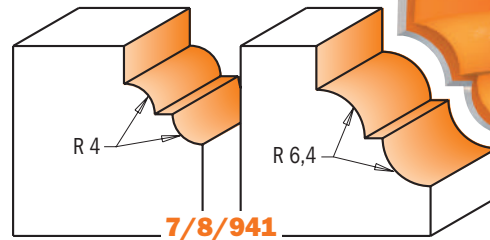

An extra horizontal cutting edge provides refined style and elegance to these traditional profiles **7/8/940**.

SHOP TIPS: for best results, multiple passes are recommended.

R mm	D mm	I mm		ORDER NO. S=Ø6mm	ORDER NO. S=Ø6,35mm	ORDER NO. S=Ø8mm	ORDER NO. S=Ø12mm	ORDER NO. S=Ø12,7mm
4	28,7	11,5	10	740.270.11	840.270.11	940.270.11	940.770.11	840.770.11
6,4	38,1	17,3	10	740.350.11	840.350.11	940.350.11	940.850.11	840.850.11
4	33,4	13	10	741.285.11	841.285.11	941.285.11	941.785.11	841.785.11
6,4	42,8	18,5	10	741.380.11	841.380.11	941.380.11	941.880.11	841.880.11

Spare parts			
990.423.00	791.003.00	990.058.00	991.057.00
990.423.00	791.003.00	990.058.00	991.057.00
990.423.00	791.003.00	990.058.00	991.057.00
990.423.00	791.003.00	990.058.00	991.057.00

SHOP TIPS: after resharpening, replace bearing 791.003.11 (Ø12,7mm) with undersized bearing **791.063.00** (Ø12,5mm)

Classical Ogee Bits

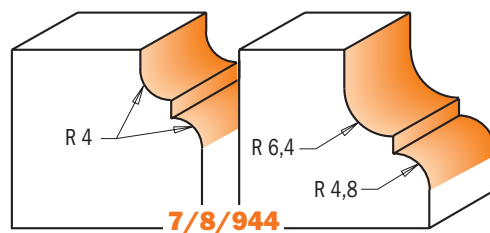
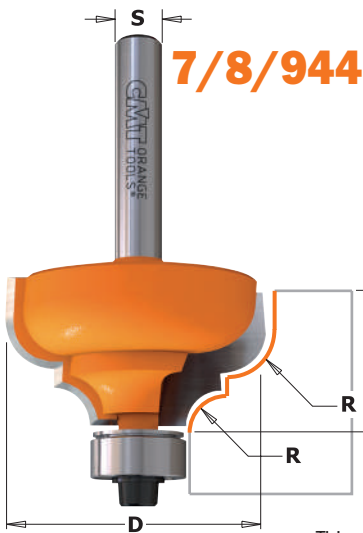

Drawing is 1:1 scale

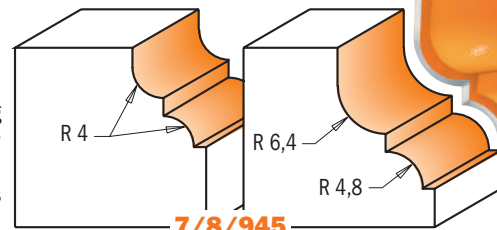

CMT's classical ogee bits feature an inverted ogee profile, with the concave edge adjacent to the upper surface of the workpiece. A vertical bead was added to separate the curves and creates an attractive detail.

SHOP TIPS: this type of machining can be very challenging, for best results, multiple passes are recommended.

This profile includes a horizontal bead along the bottom of the profile adding a decorative detail to the traditional ogee design.

SHOP TIPS: for best results, multiple passes are recommended.

R mm	D mm	I mm		ORDER NO. S=Ø6mm	ORDER NO. S=Ø6,35mm	ORDER NO. S=Ø8mm	ORDER NO. S=Ø12mm	ORDER NO. S=Ø12,7mm
4	28,7	13	10	744.287.11	844.287.11	944.287.11	944.787.11	844.787.11
6,4-4,8	35	18,5	10	744.350.11	844.350.11	944.350.11	944.850.11	844.850.11
4	28,7	13	10	745.287.11	845.287.11	945.287.11	945.787.11	845.787.11
6,4-4,8	35	18,5	10	745.350.11	845.350.11	945.350.11	945.850.11	845.850.11

Spare parts			
990.423.00	791.003.00	990.058.00	991.057.00
990.423.00	791.003.00	990.058.00	991.057.00
990.422.00	791.002.00	990.058.00	991.057.00
990.422.00	791.002.00	990.058.00	991.057.00

SHOP TIPS: after resharpening, replace bearing as follow:
791.002.00 (Ø9,5mm) with undersized bearing **791.062.00** (Ø9,3mm)
791.003.00 (Ø12,7mm) with undersized bearing **791.063.00** (Ø12,5mm)

Ogee with Fillet Bits



7/8/946

The new decorative possibilities with this bit are endless. Every bit is composed of the highest quality tungsten carbide and protected with our orange trademarked P.T.F.E. coating.

SHOP TIPS: this type of machining can be very challenging, for best results, multiple passes are recommended.

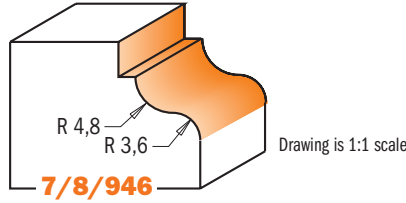

7/8/946

Drawing is 1:1 scale

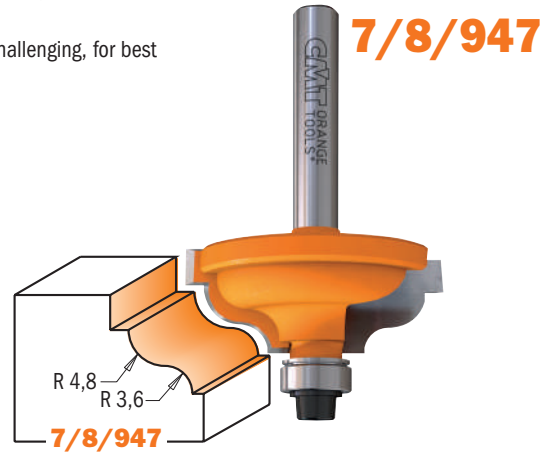

7/8/947

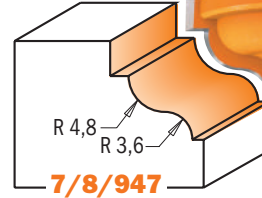

7/8/947

R mm	D mm	I mm		ORDER NO. S=Ø6mm	ORDER NO. S=Ø6,35mm	ORDER NO. S=Ø8mm	ORDER NO. S=Ø12mm	ORDER NO. S=Ø12,7mm
4,8-3,6	34,2	13	10	746.325.11	846.325.11	946.325.11	946.825.11	846.825.11
4,8-3,6	34,2	13	10	747.325.11	847.325.11	947.325.11	947.825.11	847.825.11

Spare parts

990.423.00	791.003.00	990.058.00	991.057.00
990.423.00	791.003.00	990.058.00	991.057.00

SHOP TIPS: after resharpening, replace bearing as follow:
791.002.00 (Ø9,5mm) with undersized bearing **791.062.00** (Ø9,3mm)
791.003.00 (Ø12,7mm) with undersized bearing **791.063.00** (Ø12,5mm)

Ogee Bits

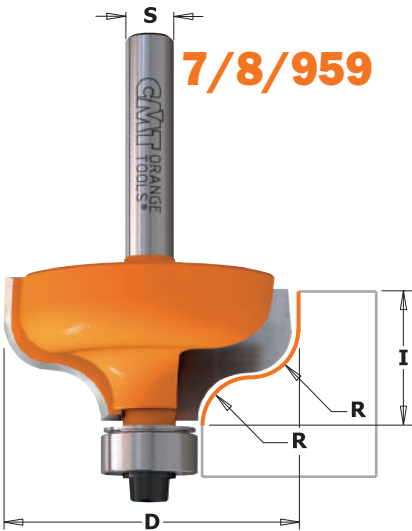

7/8/959

These profiles are the mirror image of the traditional roman ogee. They add sharp defining details to the edges of cabinets and furniture, before rolling into a smooth convex shape.

SHOP TIPS: this type of machining can be very challenging, for best results, multiple passes are recommended.

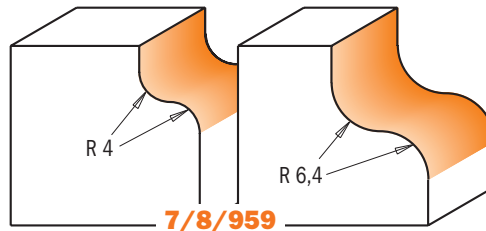

7/8/959

Drawing is 1:1 scale

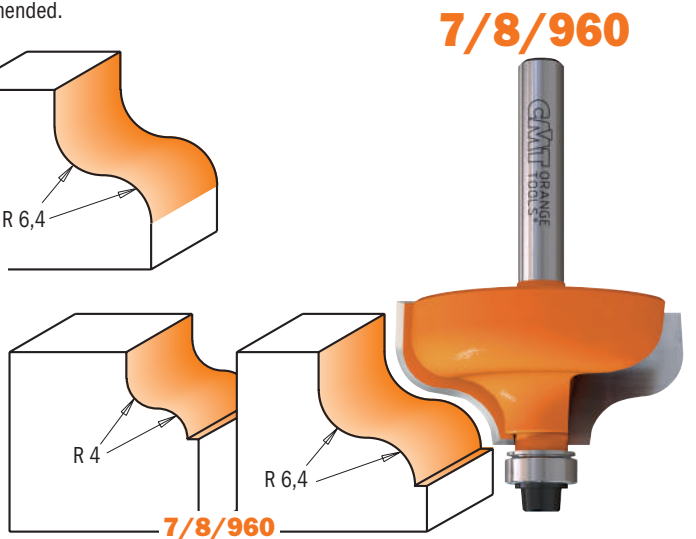

7/8/960

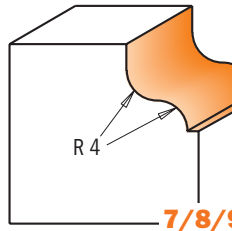

7/8/960

R mm	D mm	I mm		ORDER NO. S=Ø6mm	ORDER NO. S=Ø6,35mm	ORDER NO. S=Ø8mm	ORDER NO. S=Ø12mm	ORDER NO. S=Ø12,7mm
4	28,7	13	10	759.040.11	859.040.11	959.040.11	959.540.11	859.540.11
6,4	38,1	18	10	759.064.11	859.064.11	959.064.11	959.564.11	859.564.11
4	28,7	13	10	760.040.11	860.040.11	960.040.11	960.540.11	860.540.11
6,4	38,1	18	10	760.064.11	860.064.11	960.064.11	960.564.11	860.564.11

Spare parts

990.423.00	791.003.00	990.058.00	991.057.00
990.423.00	791.003.00	990.058.00	991.057.00
990.422.00	791.002.00	990.058.00	991.057.00
990.422.00	791.002.00	990.058.00	991.057.00

SHOP TIPS: after resharpening, replace bearing as follow:
791.002.00 (Ø9,5mm) with undersized bearing **791.062.00** (Ø9,3mm)
791.003.00 (Ø12,7mm) with undersized bearing **791.063.00** (Ø12,5mm)

Adjustable Roundover & Bevel Router Bits



8/900.623



These CMT bits are ideal for making attractive edgework! Create a double 4,76mm (3/16") roundover profile, a double 45° bevel or even a mixed profile on your wood panels easily and in a cost-effective way! Interchangeable shims are included to allow for different stock thicknesses according to the board. To be used on table-mounted routers. Do not use these bits with hand-held power tools.

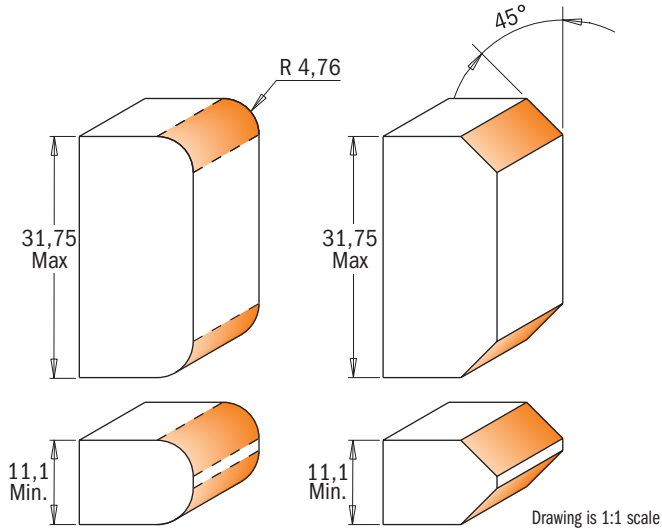

D mm	T ₁ mm	R mm	A	L mm		ORDER NO. S=Ø12mm	ORDER NO. S=Ø12,7mm
38,1	11,1 - 31,75	4,76	45°	100	10	900.623.11	
38,1	11,1 - 31,75	4,76	45°	100	10		800.623.11

Spare parts

		45° R	R 45°	
924.137.00	791.037.00	822.029.11	822.030.11	990.020.00
824.137.00	791.037.00	822.029.11	822.030.11	990.020.00

Spare parts: 541.500.00 3mm spacer
541.515.00 0,1mm spacer
541.517.00 0,5mm spacer

541.518.00 1mm spacer
541.519.00 5,8mm spacer

Adjustable Double Roundover Router Bits

8/900.622



Create awesome furnishing decorations with these new CMT bits! They provide a double 2mm (5/64") and 3mm (1/8") roundover profile on your wood panels easily and in a cost-effective way! To be used on table-mounted routers. Do not use these bits with hand-held power tools. Router tables only.

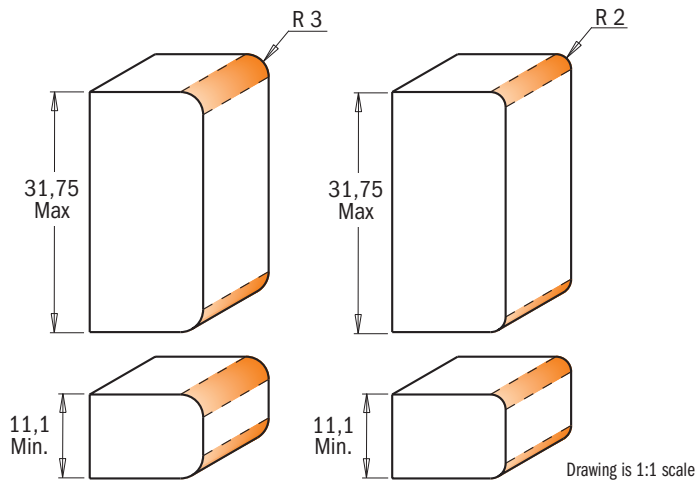
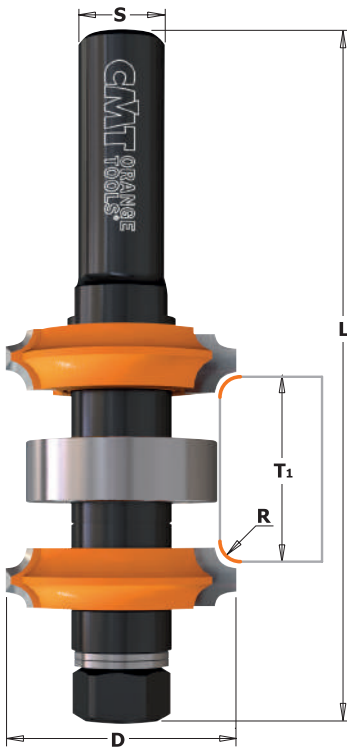

D mm	T ₁ mm	R mm	L mm		ORDER NO. S=Ø12mm	ORDER NO. S=Ø12,7mm
34	11,1 - 31,75	3 - 2	100	10	900.622.11	
34	11,1 - 31,75	3 - 2	100	10		800.622.11

Spare parts

		R2 R3	R3 R2	
924.137.00	791.037.00	822.031.11	822.032.11	990.020.00
824.137.00	791.037.00	822.031.11	822.032.11	990.020.00

Spare parts: 541.500.00 3mm spacer
541.501.00 4mm spacer
541.515.00 0,1mm spacer

541.516.00 0,3mm spacer
541.518.00 1mm spacer
541.519.00 5,8mm spacer

Wainscot/Paneling Bits

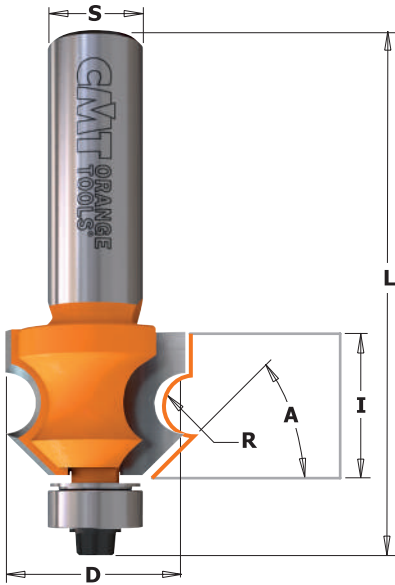

8/961.6

This new router bit designed for 19mm (3/4") thick stock is perfect for creating wainscots and panels on your walls. Simply create a 6,35mm (1/4") tongue-and-groove interlock with a CMT 8/900.626.11, then, with two passes mill an attractive traditional beadboard profile with this new bit. Perfect for cabinets, bookcase backings, ceiling and wall paneling.

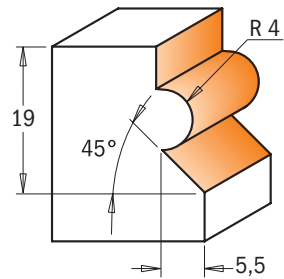
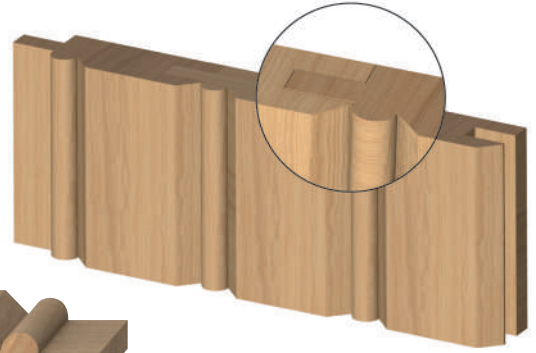

Drawing is 1:1 scale

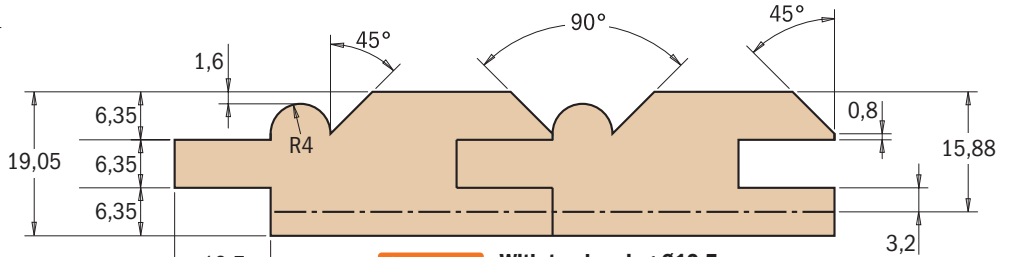

Standard With top bearing Ø12,7mm (791.003.00)

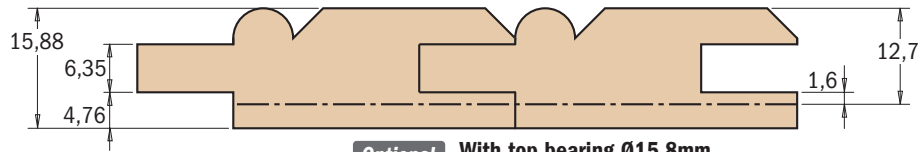

Optional With top bearing Ø15,8mm (791.018.00)

D mm	I mm	R mm	A	L mm		ORDER NO. S=Ø12mm	ORDER NO. S=Ø12,7mm
23,8	19,05	4	45°	67,7	10	961.601.11	861.601.11

Spare parts

990.423.00	791.003.00	990.058.00	991.057.00

SHOP TIPS: after resharping, replace bearing 791.003.11 (Ø12,7mm) with undersized bearing 791.063.00 (Ø12,5mm)

Corner Beading Bit with 45° Chamfer

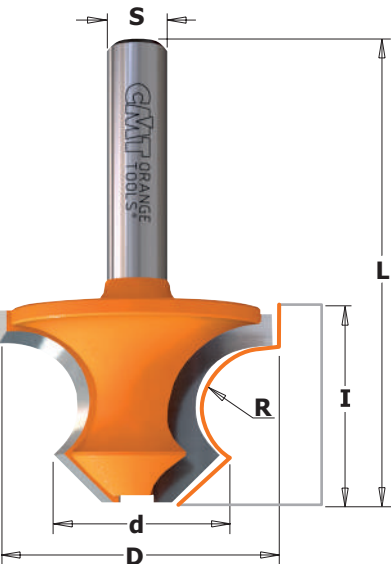

954

An innovative bit to create beautiful edges and corner beads.

SAFETY TIPS: to be used only on CNC machines or router tables equipped with a fence.

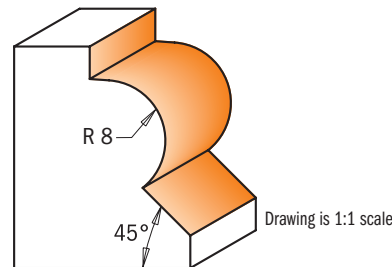

Drawing is 1:1 scale

D mm	d mm	I mm	R mm	L mm		ORDER NO. S=Ø8mm
36	22	25	8	60	10	954.080.11

Bead & Bull Nose Bits



7/8/954

CMT's bull nose bits create elegantly finished edges on stair treads, window sills and shelves in one pass. Add a final touch by using a cutter with a bead diameter wider than the stock thickness.

SAFETY TIPS: to be used only on router tables equipped with a fence except in the case Do not remove the workpiece while the bit is routing.

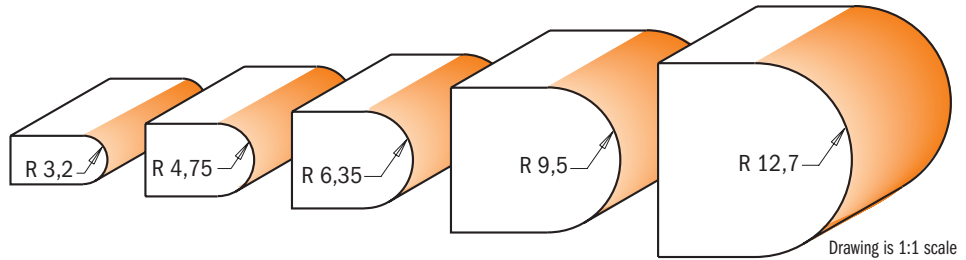
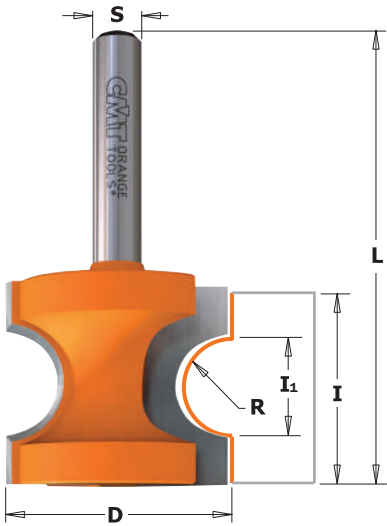

Drawing is 1:1 scale

R mm	D mm	I ₁ mm	I mm	L mm		ORDER NO. S=Ø6mm	ORDER NO. S=Ø6,35mm	ORDER NO. S=Ø8mm	ORDER NO. S=Ø12mm	ORDER NO. S=Ø12,7mm
3,2	22,2	6,56	19	50,8	10	754.002.11	854.002.11	954.002.11		
3,2	22,2	6,56	19	57,2	10				954.502.11	854.502.11
4,75	25,4	9,85	22	54	10	754.003.11	854.003.11	954.003.11		
4,75	25,4	9,85	22	60,4	10				954.503.11	854.503.11
6,35	28,6	13,15	25,5	57,2	10	754.004.11	854.004.11	954.004.11		
6,35	28,6	13,15	25,5	63,5	10				954.504.11	854.504.11
9,5	34,9	19,71	35	73	10				954.507.11	854.507.11
12,7	44,5	26,3	41	79,4	10				954.509.11	854.509.11

Corner Beading Bits

7/8/961



Make beautiful traditional beads and edge beads or turn old beads into new moldings with the new CMT corner beading bits with bearing. Featuring carbide-tipped cutting edges and orange P.T.F.E. non-stick coating, these bits provide excellent results on corner beads. Run the bead twice to form a complete corner bead.

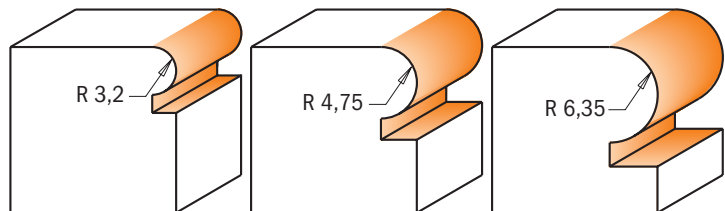
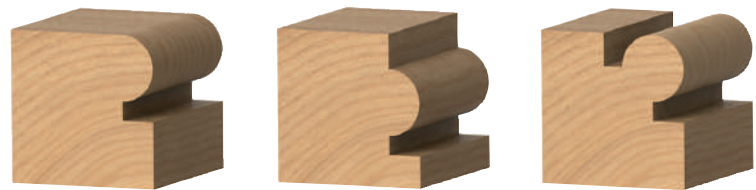
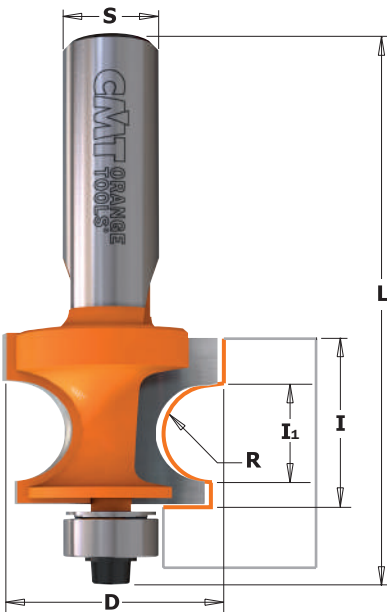

Drawing is 1:1 scale

R mm	D mm	I ₁ mm	I mm	L mm		ORDER NO S=Ø6mm	ORDER NO S=Ø6,35mm	ORDER NO S=Ø8mm	ORDER NO S=Ø12mm	ORDER NO S=Ø12,7mm	Spare parts		
3,2	22,2	6,50	15	57,7	10	761.032.11	861.032.11	961.032.11					
3,2	22,2	6,50	15	64	10				961.532.11	861.532.11	990.423.00	791.003.00	990.058.00
4,75	25,4	9,68	18,6	61,2	10	761.048.11	861.048.11	961.048.11			990.423.00	791.003.00	990.058.00
4,75	25,4	9,68	18,6	67,6	10				961.548.11	861.548.11	990.423.00	791.003.00	990.058.00
6,35	28,6	12,86	22,2	64,8	10	761.064.11	861.064.11	961.064.11			990.423.00	791.003.00	990.058.00
6,35	28,6	12,86	22,2	71,7	10				961.564.11	861.564.11	990.423.00	791.003.00	990.058.00

Spare parts: 991.057.00 3/32" hex key

Edge-Fluting Bits

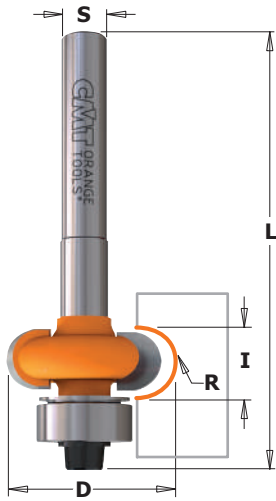

7/862

The edge-fluting bearing guided bits are quick to set up and can be used for curved screens, small radius grooves, doors etc. No side fence is required. Use in a handheld or table-mounted router.



For top bearing version: use bearing **791.010.00** and stop collar **541.001.00** (optional)

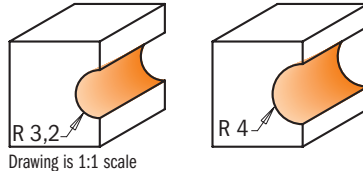

Drawing is 1:1 scale

R mm	D mm	I mm	L mm		ORDER NO. S=∅6mm	ORDER NO. S=∅6,35mm
3,2	19,05	6,4	57	10	762.032.11	862.032.11
4	20,7	8	57	10	762.040.11	862.040.11
5	22,7	10	57	10	762.050.11	862.050.11

Spare parts

990.423.00	791.003.00	990.058.00	991.057.00
990.423.00	791.003.00	990.058.00	991.057.00
990.423.00	791.003.00	990.058.00	991.057.00

CMT Moulding System

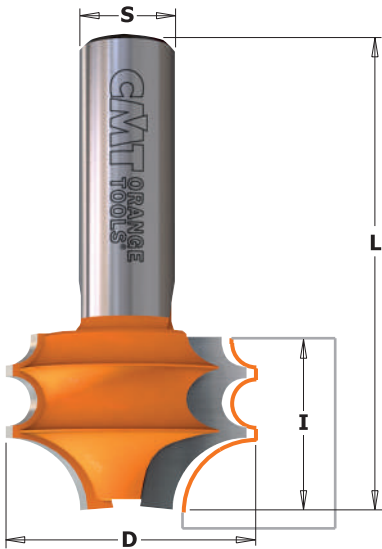

8/956.852

If the standard selection of moulding and mill work you find in today's lumber shops isn't satisfactory to your woodworking tastes, then look to CMT's moulding system instead. With these bits, you can make dozens of elaborate profiles by combining two or more passes. Avoid the average and create your own mouldings. Some initial suggestions are illustrated below.

SAFETY TIPS: use these bits with a fence. The profiles shown below are milled from heavy stock then refined to the desired shape.



8/956.851

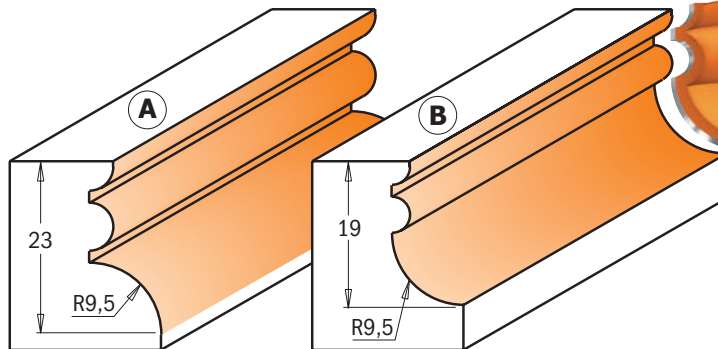

Drawing is 1:1 scale

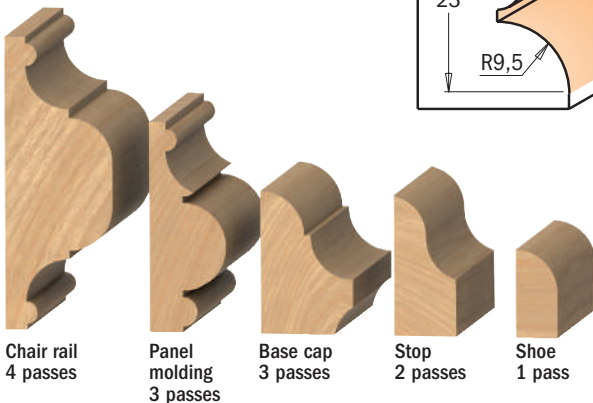

PROFILE	D mm	I mm	L mm		ORDER NO. S=∅12mm	ORDER NO. S=∅12,7mm
A	31,7	23	61,1	10	956.852.11	856.852.11
B	31,7	19	57,2	10	956.851.11	856.851.11

8/956.8



Create endless profiles with CMT multiprofile bits. Simply adjust the height of the bit to create classic profiles in one single pass, or make more complex decorative effects in multiple passes. The bits super-strength steel body can withstand long-lasting cutting operations, and the micrograin carbide tips remain sharp longer for superior performance. In addition these bits feature non-stick P.T.F.E. coating and anti-kickback design. To be used on tables equipped with a fence.

SAFETY TIPS: to make small mouldings as shown below, cut the profile from large stock, removing excess material as you work as this will facilitate easier control. Keep hands far from the bit when working.

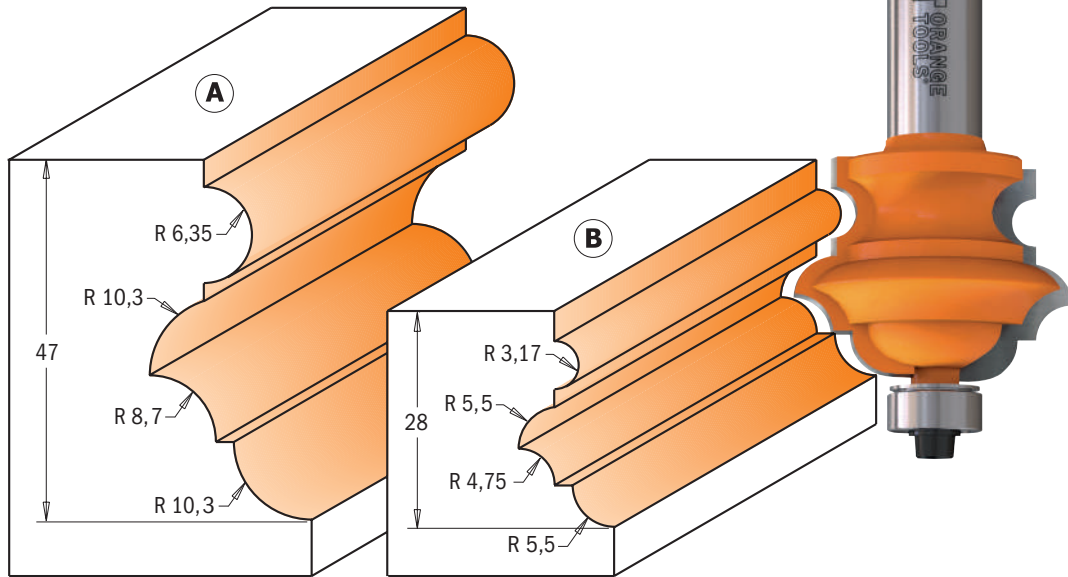
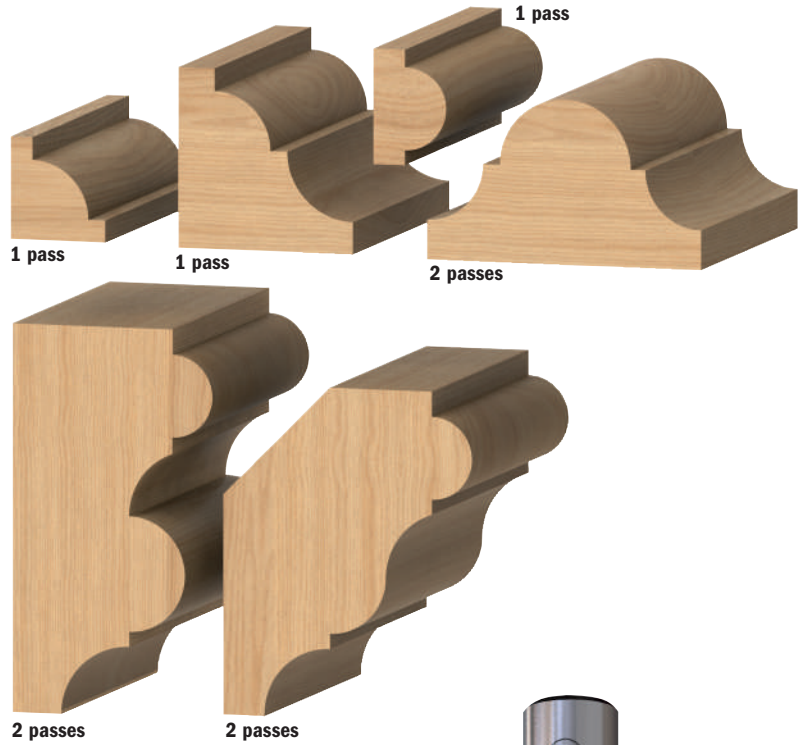
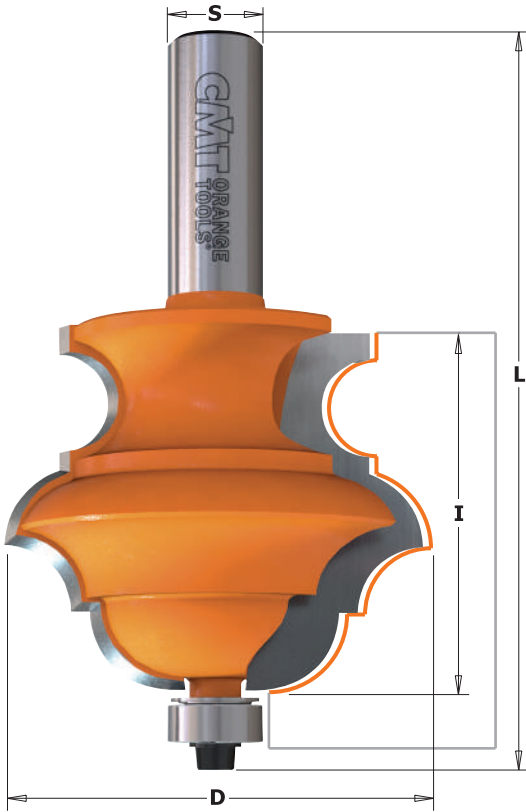

Drawing is 1:1 scale

PROFILE	D mm	I mm	L mm		ORDER NO. S=Ø12mm	ORDER NO. S=Ø12,7mm	Spare parts			
A	55,6	47	96,4	5	956.802.11	856.802.11				
B	38,1	28	77,5	10	956.801.11	856.801.11	990.423.00	791.003.00	990.058.00	991.057.00

Moulding Bits

For best results use these bits with 1800W routers. It is possible to use 1100W routers but only for brief passes that are short in depth.



SHOP TIPS: multiple pass operations require advance planning. To avoid making a mistake that could render it impossible to finish the job, carefully consider the entire cutting sequence before you begin.

SAFETY TIPS: all large diameter bits such as these should be used with caution and on router tables equipped with a fence. When possible, reduce the RPM.

8/956.501

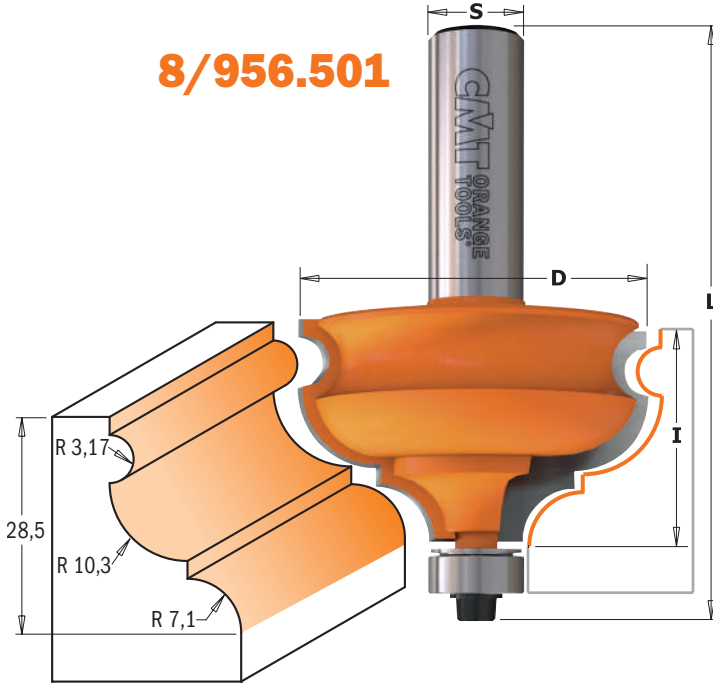

8/955.901

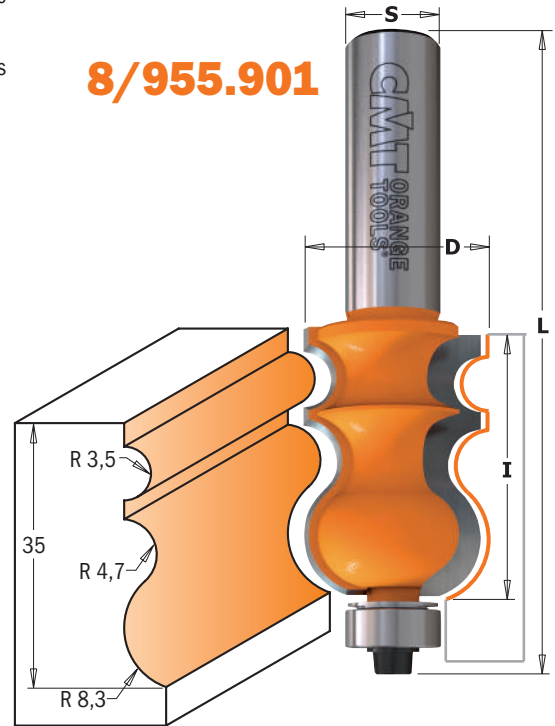



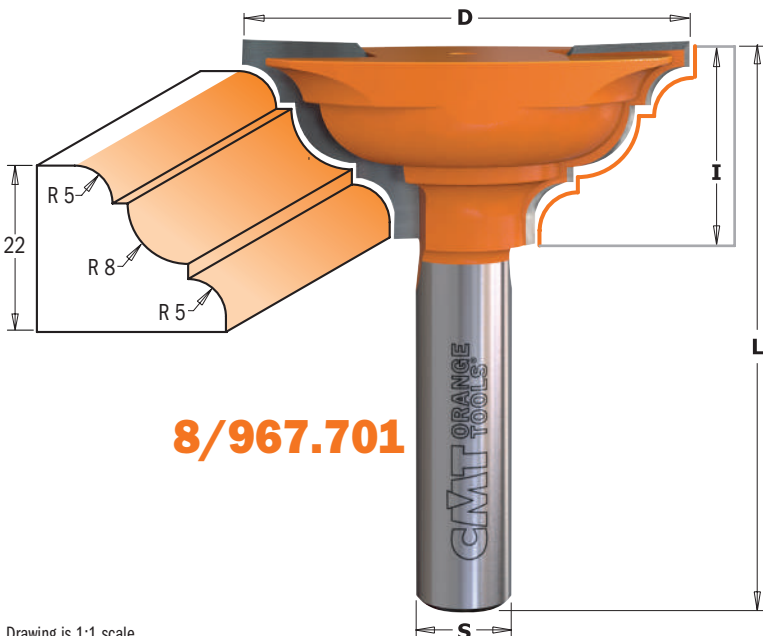

8/967.701

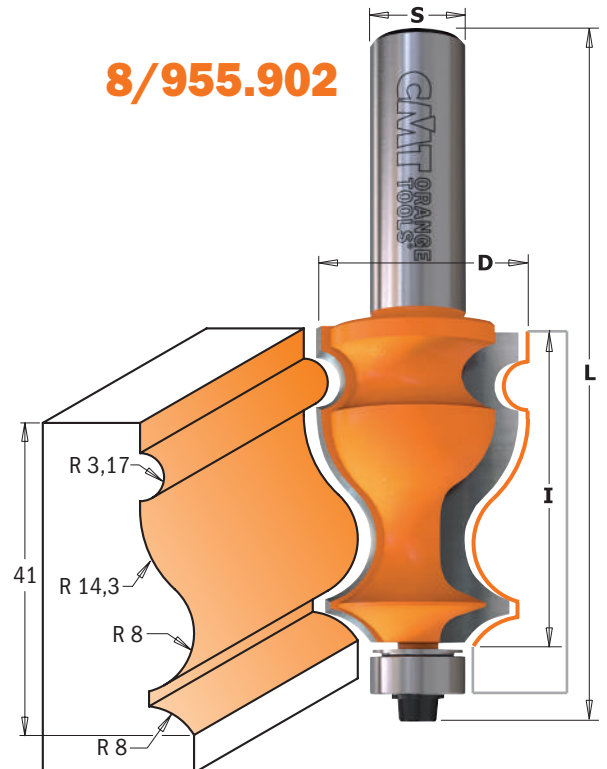

8/955.902

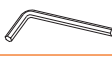

Drawing is 1:1 scale

D mm	I mm	L mm		 ORDER NO. S=Ø12mm	ORDER NO. S=Ø12,7mm	Spare parts				
23,8	35	83,8		10	955.901.11	855.901.11				
27	41	90,2		10	955.902.11	855.902.11	990.423.00	791.003.00	990.058.00	991.057.00
47,5	28,5	77,4		10	956.501.11	856.501.11	990.423.00	791.003.00	990.058.00	991.057.00
59	25,4	73,5		10	967.701.11	867.701.11	990.423.00	791.003.00	990.058.00	991.057.00

SHOP TIPS: after resharpening, replace bearing 791.003.11 (Ø12,7mm) with undersized bearing 791.063.00 (Ø12,5mm)

Moulding Bits

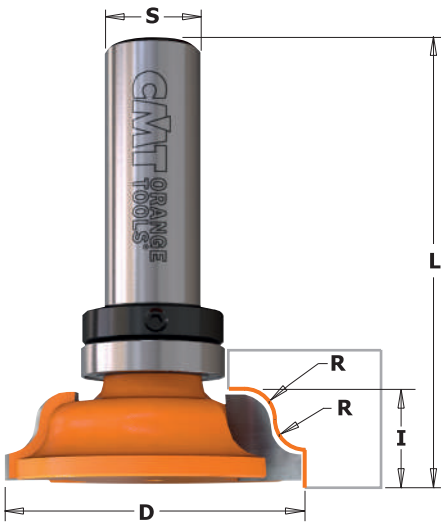

8/967.5B - 8/967.6B



CMT's new moulding bits allow you to shape elegant moldings with your table saw and router. Unlike any commercially available crown moldings, moldings made with these bits are easy to install and create a finished appearance. After shaping the cove, you can use special router bits with inverted profiles to create different edges and complete the moulding.

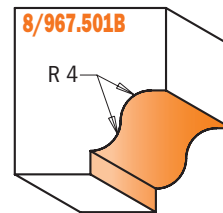
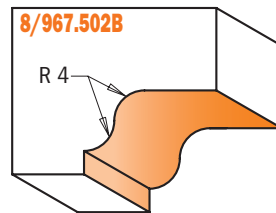
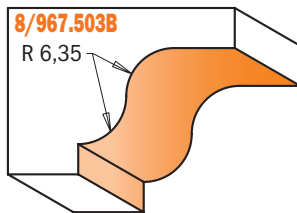
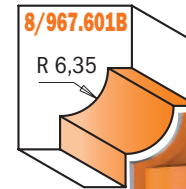
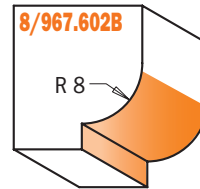
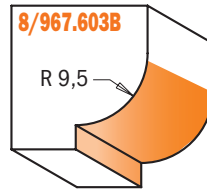

Drawing is 1:1 scale

R mm	D mm	I mm	L mm		ORDER NO. S=Ø8mm	ORDER NO. S=Ø12mm	ORDER NO. S=Ø12,7mm
4	39	11,5	57	10	967.001.11B	967.501.11B	867.501.11B
4	54	11,5	65,9	10		967.502.11B	867.502.11B
6,35	60,5	17,3	71,7	5		967.503.11B	867.503.11B
6,35	38	12,5	57	10		967.601.11B	867.601.11B
8	35	13,2	57,7	10	967.102.11B	967.602.11B	867.602.11B
9,5	38	14,5	59	10	967.103.11B	967.603.11B	867.603.11B

Spare parts

791.011.00	541.002.00	990.005.00	991.056.00
791.011.00	541.002.00	990.005.00	991.056.00
791.011.00	541.002.00	990.005.00	991.056.00
791.011.00	541.002.00	990.005.00	991.056.00
791.011.00	541.002.00	990.005.00	991.056.00
791.011.00	541.002.00	990.005.00	991.056.00

Door Lip Bit & Finger Grip Bit

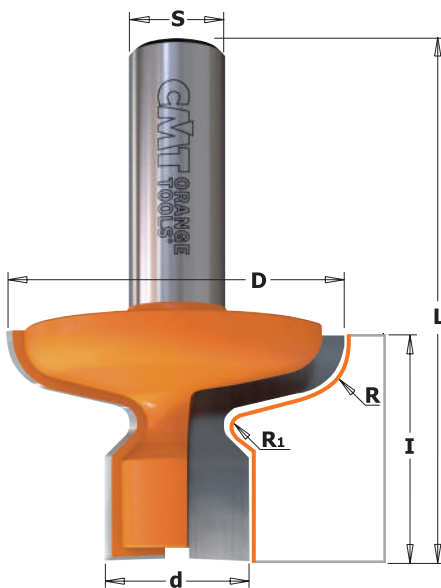

8/955.604-606



Why interrupt the subtle linearity of an all-wood drawer front or cabinet door with a metal knob or handle? Two options are available: a template profile made directly in the wood or a European-style hardwood pull as illustrated below.

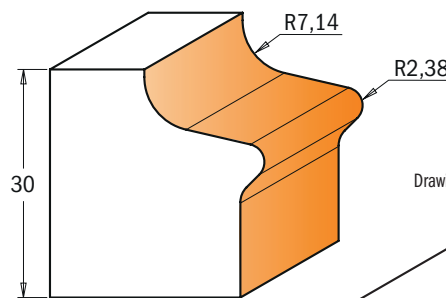

Drawing is 1:1 scale

9/855.604.11

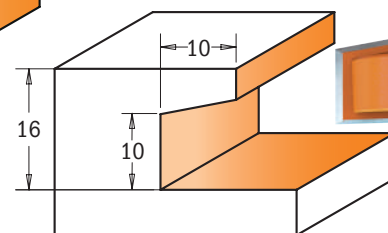

9/855.606.11

D mm	d mm	I mm	R mm	R ₁ mm	L mm		ORDER NO. S=Ø12mm	ORDER NO. S=Ø12,7mm
36	16	16			60	10	955.606.11	855.606.11
47,6	22,2	30	7,14	2,38	66,6	10	955.604.11	855.604.11

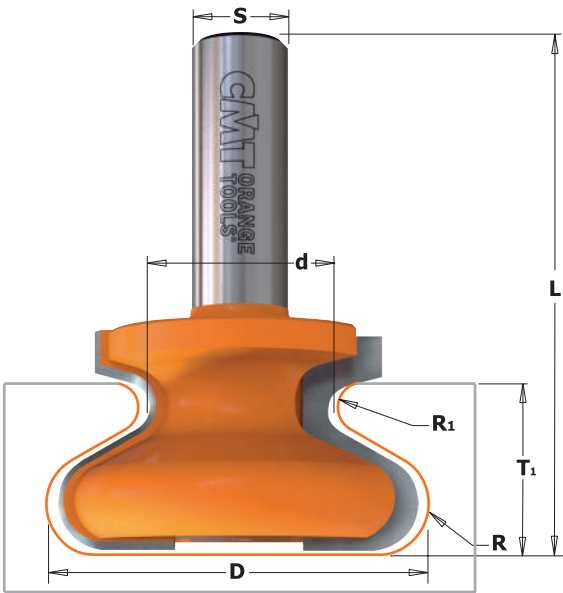

8/955



Why interrupt the subtle linearity of an all-wood drawer front or cabinet door with a metal knob or handle? Use a CMT finger pull bit and make a harmonious wooden handle. Two options are available: a template profile made directly in the wood or a European-style hardwood pull as illustrated below.

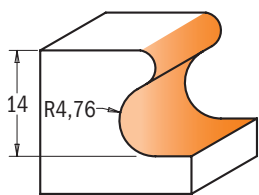
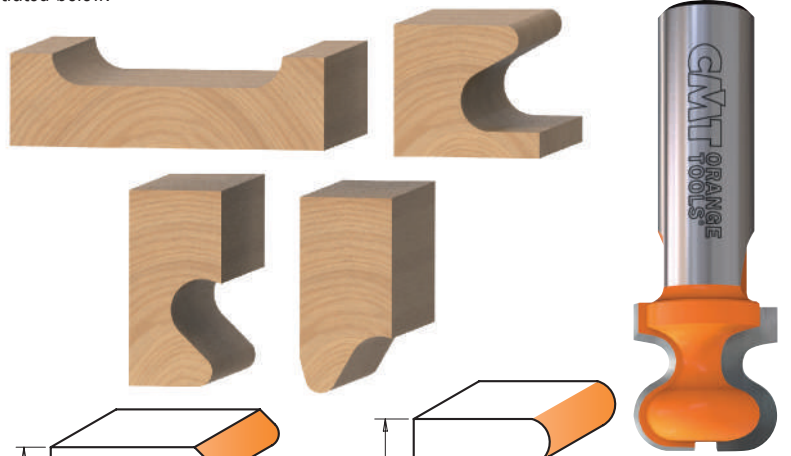

955.102.11
855.602.11

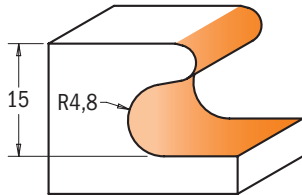

955.105.11
955.605.11
855.605.11

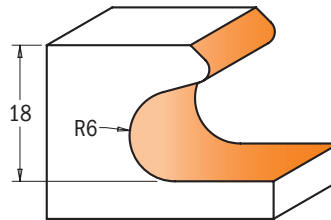

955.103.11
855.603.11

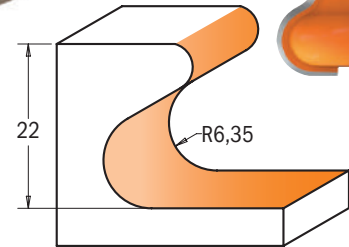

955.601.11
855.601.11

Drawing is 1:1 scale

D mm	d mm	T ₁ mm	l mm	R mm	R ₁ mm	L mm		ORDER NO. S=Ø8mm	ORDER NO. S=Ø12mm	ORDER NO. S=Ø12,7mm
19,05	9,5	14	19,05	4,76	2,4	57,2	10	955.102.11		855.602.11
29	11	15	20	4,8	2,3	60	10	955.105.11	955.605.11	855.605.11
38,1	17	18	20,7	6	1,8	55,5	10	955.103.11		
38,1	17	18	20,7	6	1,8	61,8	10			855.603.11
47,6	24	22	28,5	6,35	3,2	66,6	10		955.601.11	855.601.11

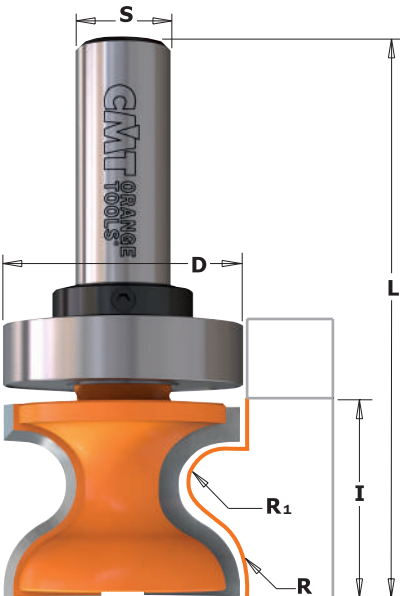

Window Sill & Finger Bits

8/955.8 - 8/955.8B



Originally, these profiles were designed for shaping the edges of window sills. Yet, these bits also can be used to create finger pulls on the edges of doors and drawers. These bits are available with top bearings for curved template work or without bearings for straight cuts against a fence. Recommended for router table use only.

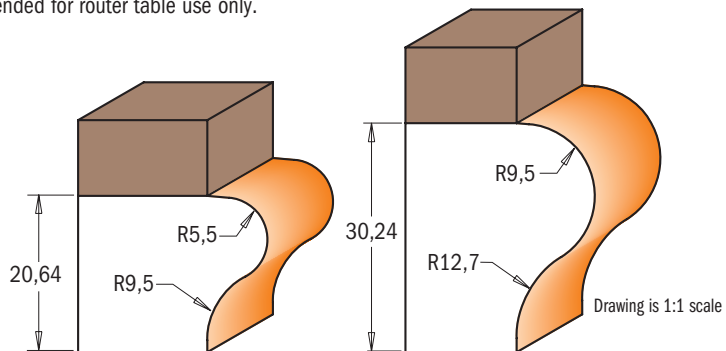

Drawing is 1:1 scale

R ₁ mm	R mm	D mm	I mm	L mm		ORDER NO. S=Ø12mm	ORDER NO. S=Ø12,7mm
5,5	9,5	31,7	25,4	73	10	955.804.11	855.804.11
9,5	12,7	38,1	35	85,8	10	955.805.11	855.805.11
WITH TOP BEARING							
5,5	9,5	31,7	25,4	73	10	955.804.11B	
5,5	9,5	31,7	25,4	73	10		855.804.11B
9,5	12,7	38,1	35	85,8	10	955.805.11B	
9,5	12,7	38,1	35	85,8	10		855.805.11B

Spare parts

791.015.00	541.005.00	990.005.00	991.056.00
791.015.00	541.002.00	990.005.00	991.056.00
791.020.00	541.005.00	990.005.00	991.056.00
791.020.00	541.002.00	990.005.00	991.056.00

Table Edge & Hand Rail Bits

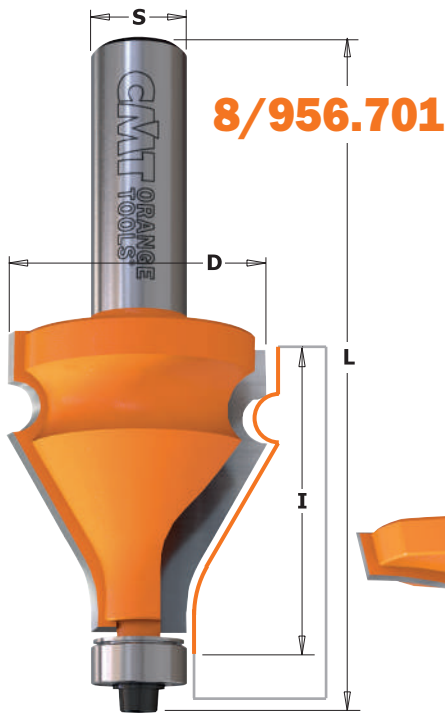

8/956.701

The **8/956.601.11** guarantees well-proportioned smooth curves. Complete the job with the **8/956.701.11** bit featuring a 30° bevel edge and a 3.2mm bead for beautifully functional hand rails.

SAFETY TIPS: these profile bits remove large amounts of stock and produce consistent quantities of dust. We recommend using a vacuum to keep the work area safe.

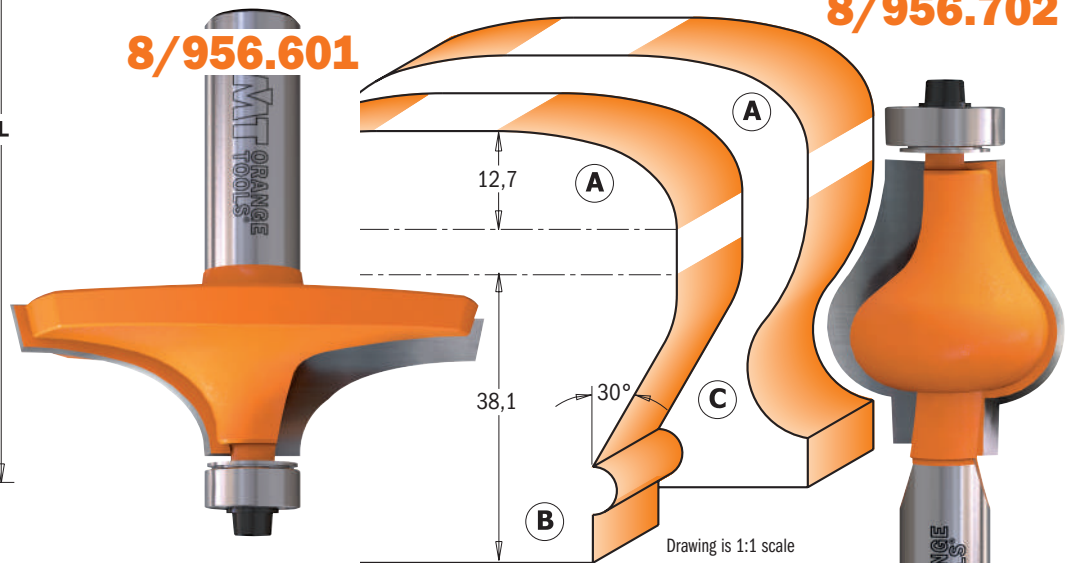

8/956.601

8/956.702

Drawing is 1:1 scale

PROFILE	D mm	I mm	L mm		ORDER NO. S=Ø12mm	ORDER NO. S=Ø12,7mm
A	63,5	19	67,9	5	956.601.11	856.601.11
B	35	38	87	10	956.701.11	856.701.11
C	31,7	38,1	87	10	956.702.11	856.702.11

Spare parts

990.423.00	791.003.00	990.058.00	991.057.00
990.423.00	791.003.00	990.058.00	991.057.00
990.423.00	791.018.00	990.058.00	991.057.00

SHOP TIPS: after resharpening, replace bearing 791.003.11 (Ø12,7mm) with undersized bearing **791.063.00** (Ø12,5mm)

Vertical Raised Panel Bits

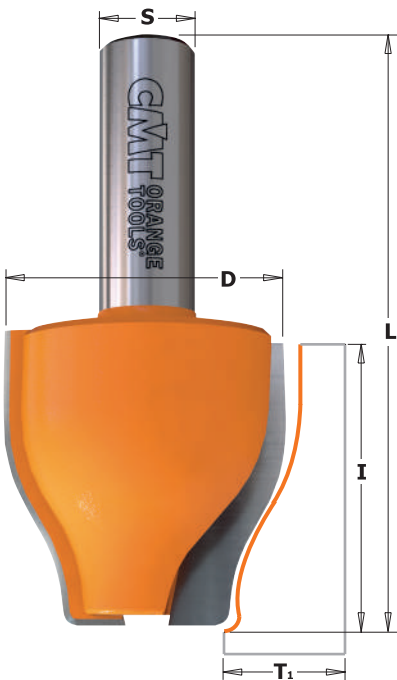

8/990.6



Use a sturdy 90° angle fence on your router table along with routers with a minimum speed of 1,7 KW (2-1/4 HP). Routers as low-powered as 1,1 KW (1-1/2 HP) can be used but we suggest limiting their use to shorter, shallower runs.

SAFETY TIPS: the template must be at least 150mm and clamps should be used whenever possible. Three to five passes are recommended to safely and accurately obtain the profile you desire.

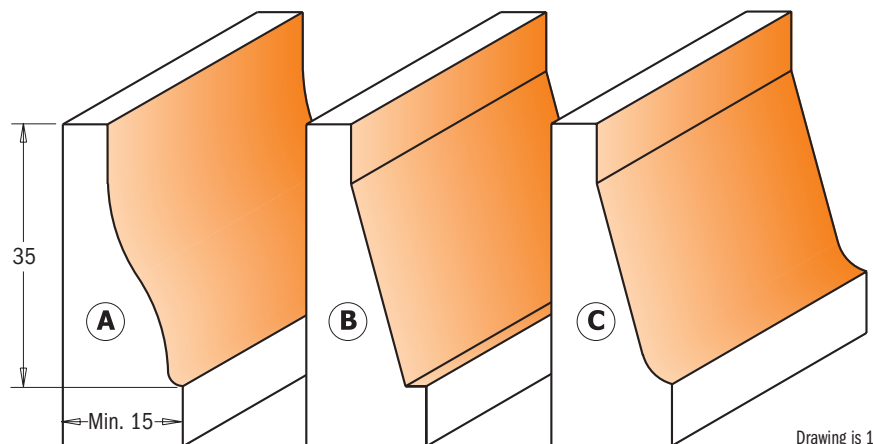

Drawing is 1:1 scale

PROFILE	D mm	I mm	T ₁ mm	L mm		ORDER NO. S=Ø12mm	ORDER NO. S=Ø12,7mm
A	38	38	15 ÷ 18	76,2	10	990.601.11	890.601.11
B	38	38	15 ÷ 18	76,2	10	990.602.11	890.602.11
C	38	38	15 ÷ 18	76,2	10	990.603.11	890.603.11

Junior Ogee Rail & Stile Set

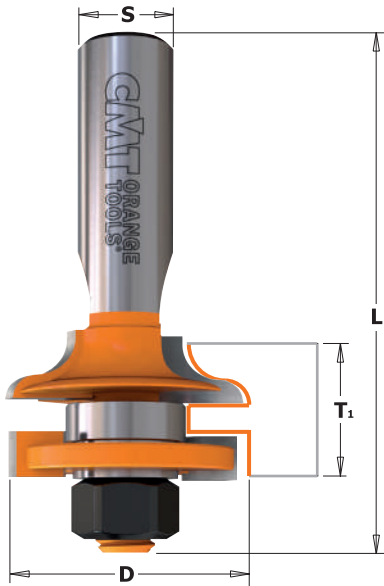

8/991.517



These bits are designed for those special projects that require a smaller panel door. Use these bits with stock from 11,1mm to 17,4mm thick, and build doors as small as 70mm.

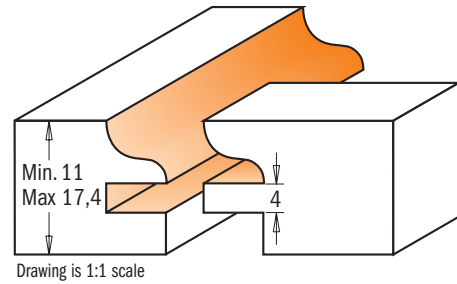

D mm	T ₁ mm	L mm		ORDER NO. S=Ø12mm	ORDER NO. S=Ø12,7mm	Spare parts							
31,75	11 ÷ 17,4	67	5	991.517.11	891.517.11					822.008.11	822.009.11	791.025.00	990.020.00

Spare parts: 541.515.00 0,1mm spacer
541.516.00 0,3mm spacer
541.518.00 1,0mm spacer

Rail & Stile Set

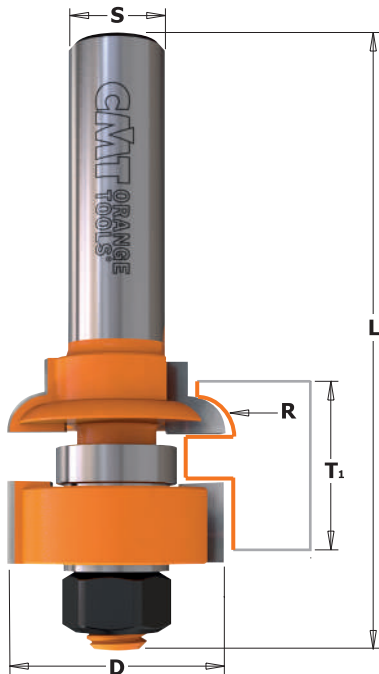

8/991



Designed for fine furniture construction, these bits mill a delicate 4,75mm thumb-nail profile in stock from 15,8mm to 20,6mm.

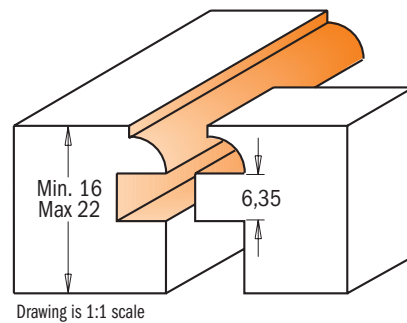

D mm	T ₁ mm	R mm	L mm		ORDER NO. S=Ø8mm	ORDER NO. S=Ø12,7mm	Spare parts							
28,7	16 ÷ 22	4,8	79,2	10	991.012.11	891.512.11					822.011.11	822.012.11	791.025.00	990.020.00

Spare parts: 541.515.00 0,1mm spacer
541.516.00 0,3mm spacer
541.518.00 1,0mm spacer

The ABC's of Panel Door Construction

In our step-by-step example of panel door construction, we used the following:

- CMT Rail & Stile set (item **891.502.11**)
- CMT Reverse Glue Joint (item **855.501.11**)
- pre-cut to length stiles - 19mm thick x 57mm wide
- pre-cut to length rails - 19mm thick x 57mm wide
- panel - 16mm thick
- scrap stock

The CMT Rail & Stile set was designed ideally for the construction of panel doors from 19mm thick stock, however any variation of size up to 22mm thick can be used. Remember to adjust your measurements and cutting depths according to the wood thickness you use.

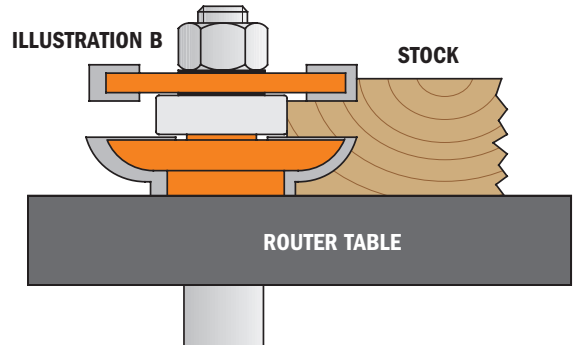
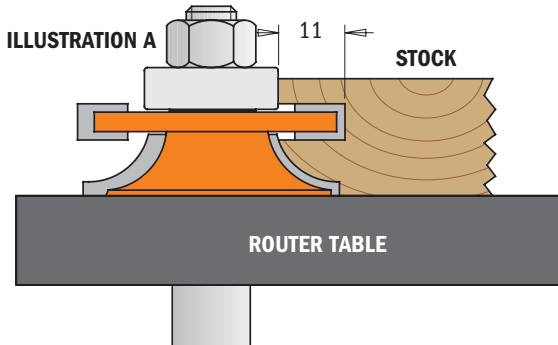
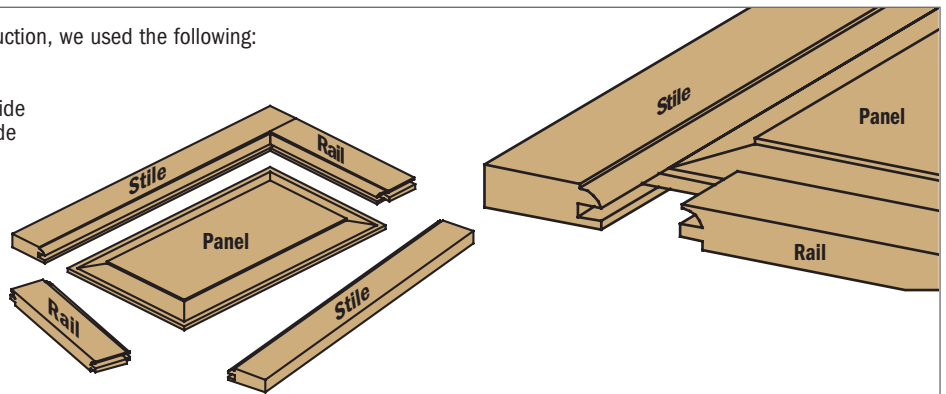

MILLING THE RAILS AND STILES

First make trial cuts of the cope profile (rail) and the stick profile (stile) in scrap stock and check the accuracy of the joint. This is extremely important when working at maximum thickness (22mm). Make sure your stock is flat and cut straight with square edges. Using the CMT Stile Bit shown in illustration A, place the stock front face-down on the router table and mill the cope profile in the stile and rail pieces. To mill the rails, use the CMT Rail Bit shown in illustration B, position the rails face-down on the router table and mill the cope profile on the ends. If you are milling cope and stick profiles before cutting the rails and stiles to length, be sure to make the proper calculations before cutting the rails. The stiles are the same length as the door. The rails must be calculated by the following equation (CMT standard tenon length is 22mm):

(total door width - sum of stile widths) + sum of 2 tenons = total rail length
 therefore, using our example measurements listed above, for a 300mm cabinet door:
 $300\text{mm} - 114\text{mm} + 22\text{mm} = 208\text{mm}$

GLUEING UP PANELS

If the panel requires a width greater than the width of your stock, you will need to edge glue stock for the central floating panel. This is accomplished by simply using the CMT Reverse Glue Joint bit. For making a two panel glue joint, place the first panel front face-down on the router table and accurately centre the wood to the bit. Adjust the bit according to the thickness of the wood you are cutting by lining up the cut edge of the wood to the centre point of the bit as illustrated in illustration B and mill the cut edge of the wood. Place the second panel front face up and repeat the milling process. This assures you will have the best side of your stock as a front face. If a third panel is required, mill one cut edge of the piece as instructed above, turn the piece over and run the other edge. Assemble the reverse cut pairs together for beautiful, strong joints that match up perfectly.

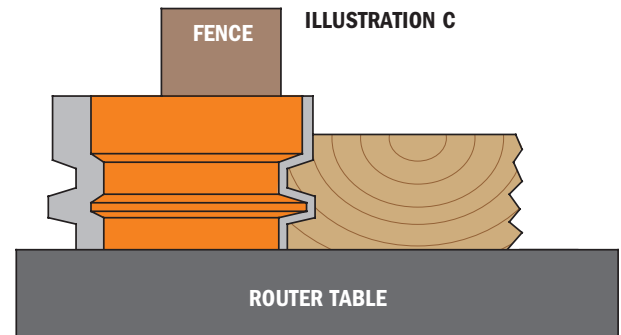

MILLING THE FLOATING PANEL

Make trial cuts in scrap stock to create a tongue that fits snugly into the groove in the stile without forcing it. To cut your panel to size be sure to make the proper calculations, taking into account the length of the tongue. The CMT Raised Panel Bit in our example has a standard tongue length of 8mm (The New CMT Raised Panel Bit profile has a 9,5mm tongue).

Use the following equation:

(Total door length - Sum of Stile widths) + Sum of 2 Tongues = Overall Panel Length

Therefore, using our example, measurements listed above for a 600mm long cabinet door: $(600 - 114) + 16\text{mm} = 502\text{mm}$

And accordingly:

(Total door width - Sum of Stile widths) + Sum of 2 Tongues = Overall Panel Width.

Once the panel has been cut to proper dimensions, position the panel front face side down on the router table tongue as shown in illustration C and use the CMT Raised Panel Bit to mill the tongue. **ATTENTION:** this bit is capable of removing large amounts of stock. To safely and effectively produce the profile you want, we suggest making several shallow passes. It can be dangerous to try to mill the entire profile in a single run.

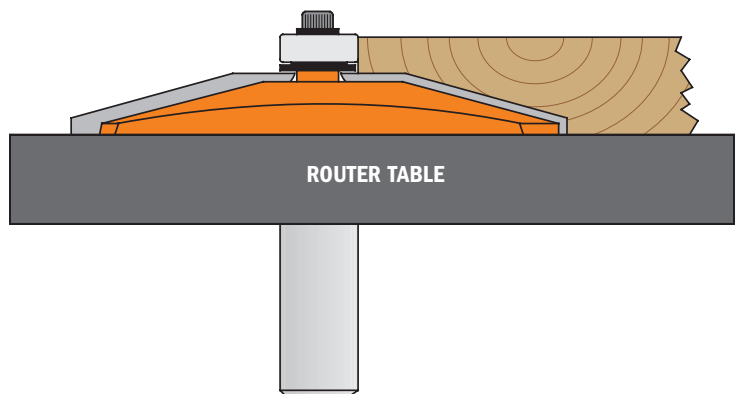

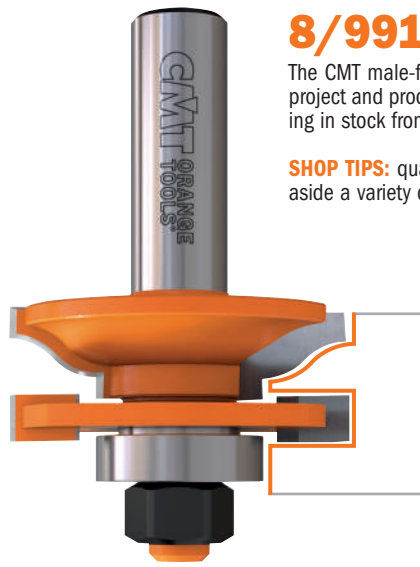
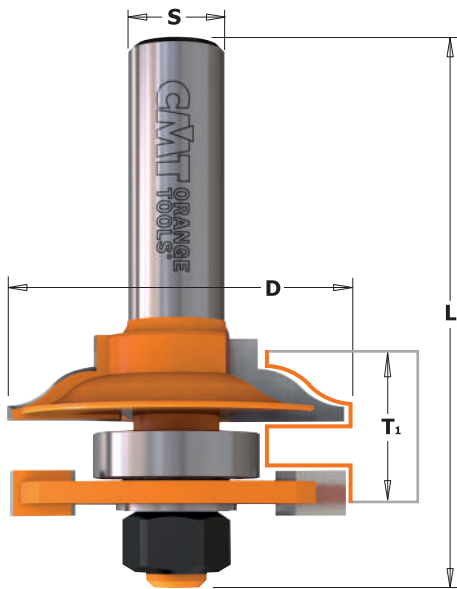

8/991



The CMT male-female rail and stile sets are a perfect pair for this particular project and produce clean, precise and well-crafted joints. Designed for working in stock from 18mm to 22mm.

SHOP TIPS: quality workmanship is the result of a lot of trial and error. Set aside a variety of small pieces for trial cuts.

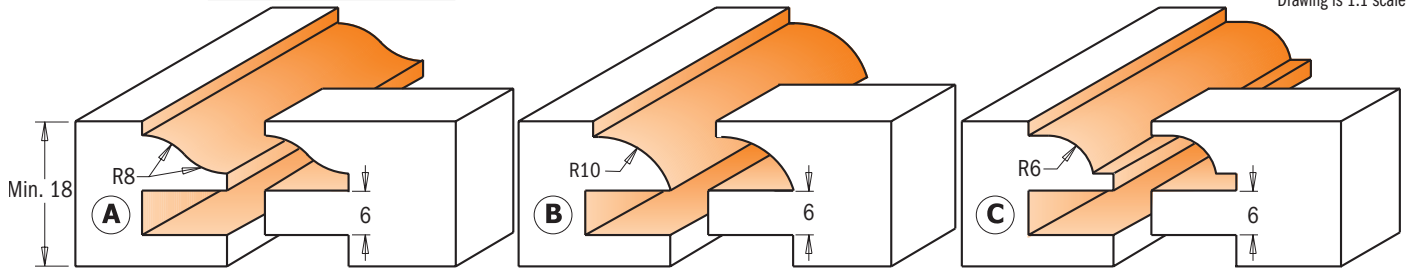

Drawing is 1:1 scale

PROFILE	D mm	L mm	T ₁ mm		ORDER NO. S=Ø8mm	ORDER NO. S=Ø12mm	ORDER NO. S=Ø12,7mm	Spare parts					
A	44,4	71	18 ÷ 22	5	991.001.11	991.501.11	891.501.11	822.003.11	791.012.00	541.515.00	514.516.00	990.407.00	990.020.00
B	44,4	71	18 ÷ 22	5	991.502.11	891.502.11	822.003.11	791.012.00	541.515.00	514.516.00	990.407.00	990.020.00	
C	44,4	71	18 ÷ 22	5	991.503.11	891.503.11	822.003.11	791.012.00	541.515.00	514.516.00	990.407.00	990.020.00	

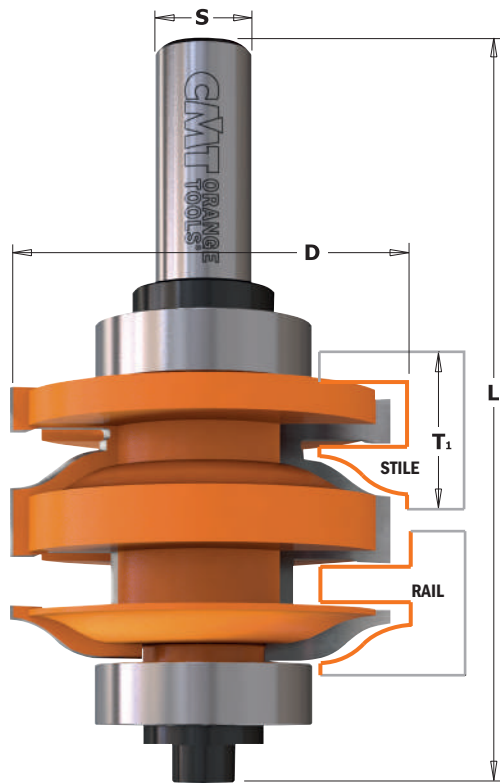

8/991.521



The new CMT One-Piece Rail and Stile Bit represents the union of two cutters in one bit. By simply adjusting the height of the bit, you can cut two perfectly joining profiles with no wasted time or effort moving the fence or changing the bit. Save time and money by investing in one single CMT cutting tool.

SHOP TIPS: the complicated nature of this kind of project requires a lot of practice and you need to carry out trial cuts. Always keep a variety of test pieces on hand.

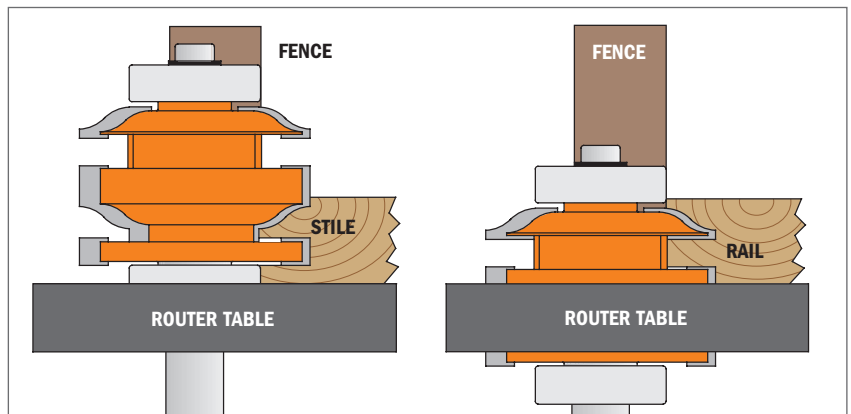

PROFILE	D mm	L mm	T ₁ mm		ORDER NO. S=Ø12mm	ORDER NO. S=Ø12,7mm	Spare parts						
A	50,87	96	18 ÷ 22	10	991.521.11	891.521.11	791.027.00	541.002.00	990.005.00	991.056.00	541.551.00	990.010.00	991.064.00
A	50,87	96	18 ÷ 22	10	991.521.11	891.521.11	791.027.00	541.005.00	990.005.00	991.056.00	541.551.00	990.010.00	991.064.00

Raised Panel Bits



8/990

Make classic raised panel doors by choosing from the profiles illustrated below. Its anti-kickback design is fundamental in further improving safety when working with larger diameter bits.

SAFETY TIPS: This type of bit needs to be used at a lower rotational speed, preferably between 10,000 and 12,000 RPMs. Three to five passes are recommended to safely and accurately obtain the profile you desire. To be used on routers with at least 1800 KW.

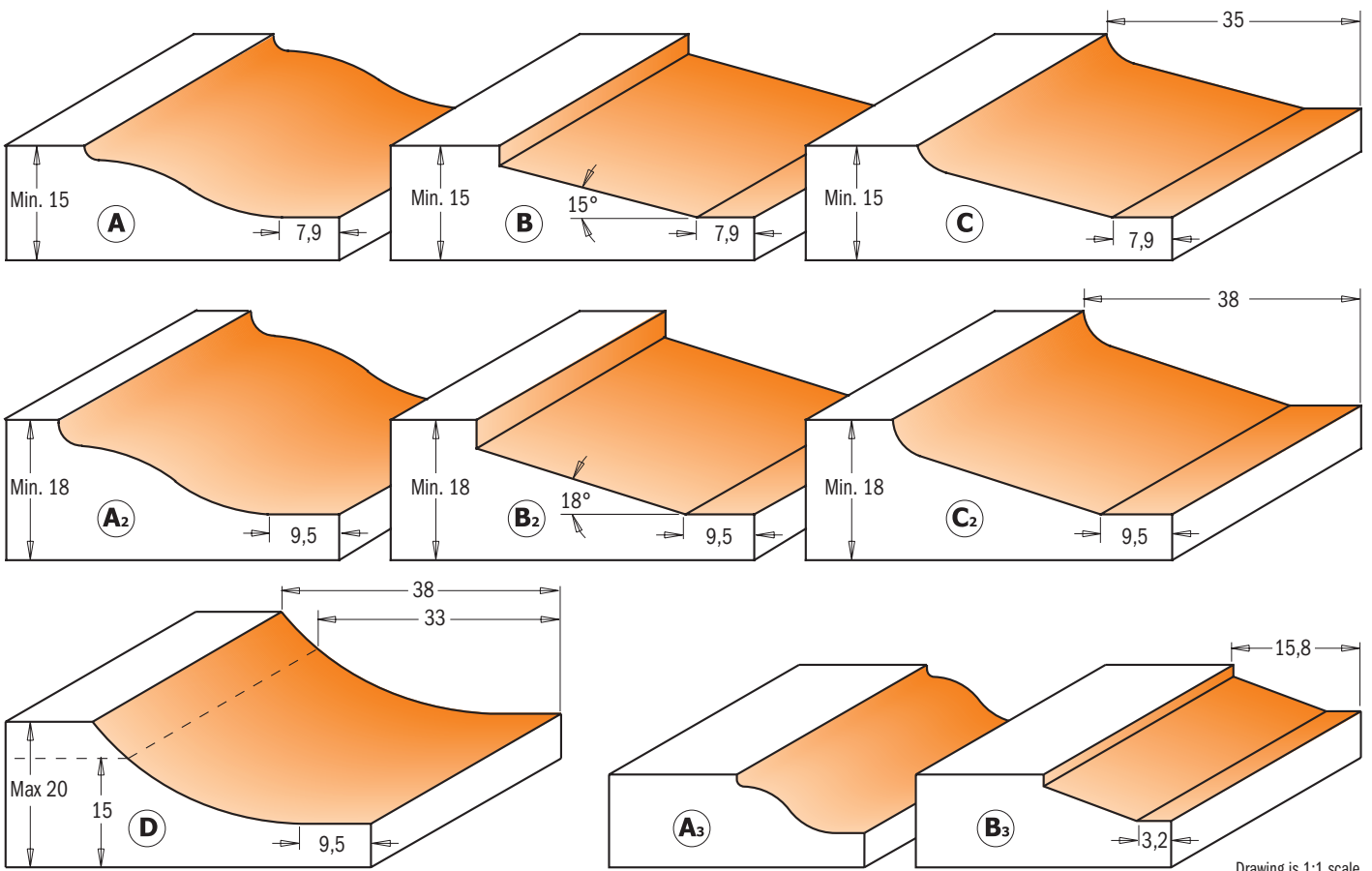
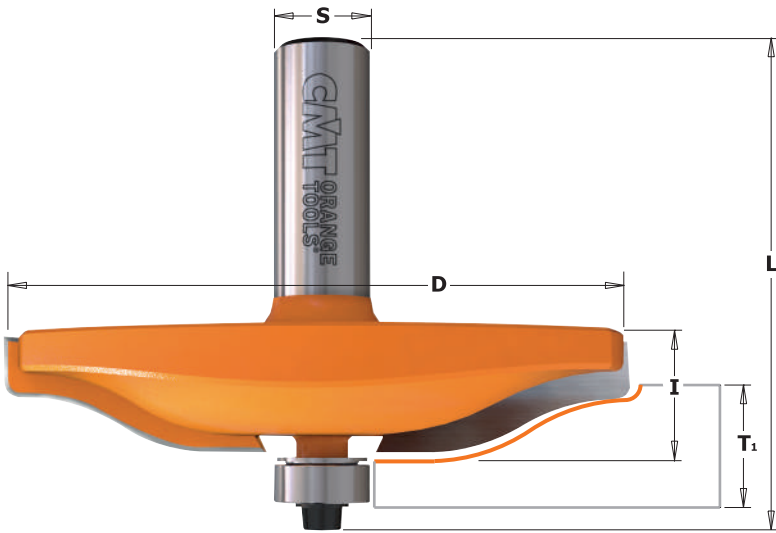

Drawing is 1:1 scale

PROFILE	D mm	I mm	L mm	T ₁ mm		ORDER NO. S=Ø8mm	ORDER NO. S=Ø12mm	ORDER NO. S=Ø12,7mm
A	82,5	15	63,8	15 ÷ 18	5		990.501.11	890.501.11
B	82,5	15	63,8	15 ÷ 18	5		990.502.11	890.502.11
C	82,5	15	64,6	15 ÷ 18	5		990.503.11	890.503.11
A ₂	89	15	64,6	18 ÷ 20	5		990.504.11	890.504.11
B ₂	89	15	64,6	18 ÷ 20	5		990.505.11	890.505.11
C ₂	89	15	64,6	18 ÷ 20	5		990.506.11	890.506.11
D	89	15	64,6	15 ÷ 20	5		990.507.11	890.507.11
A ₃	47,6	9,5	58,1	12,7 ÷ 15	10	990.011.11		
B ₃	47,6	9,5	58,1	12,7 ÷ 15	10	990.012.11		890.512.11

Spare parts

990.423.00	791.003.00	990.058.00	991.057.00
990.423.00	791.003.00	990.058.00	991.057.00
990.423.00	791.003.00	990.058.00	991.057.00
990.423.00	791.003.00	990.058.00	991.057.00
990.423.00	791.003.00	990.058.00	991.057.00
990.423.00	791.003.00	990.058.00	991.057.00
990.423.00	791.003.00	990.058.00	991.057.00
990.423.00	791.003.00	990.058.00	991.057.00
990.423.00	791.003.00	990.058.00	991.057.00
990.423.00	791.003.00	990.058.00	991.057.00

Raised Panel Bit with Back Cutter

8/990.5



These bits have a back-cutter which allows you to rout both the front and back of the panel in the same cut which saves time and money.

SAFETY TIPS: to ensure improved safety when using the Ø89mm bit, carry out the cut in 2 shallow passes: use a Ø37mm bearing for the first pass, and then a Ø16mm bearing for the second pass.

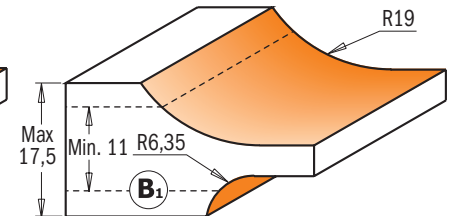
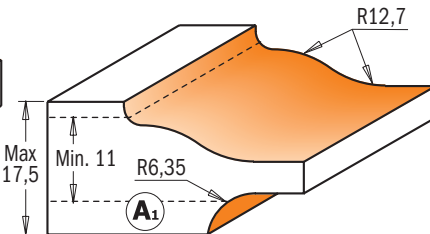
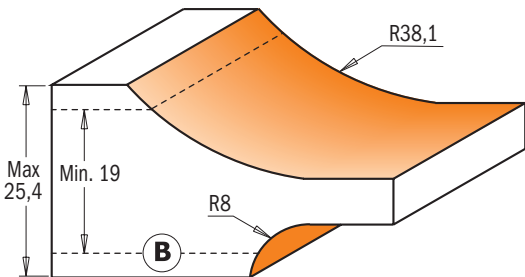
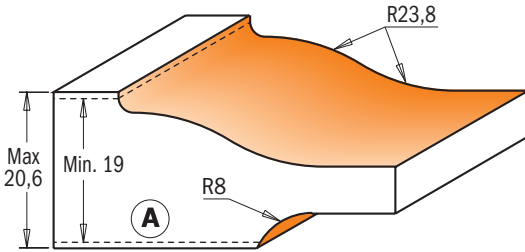
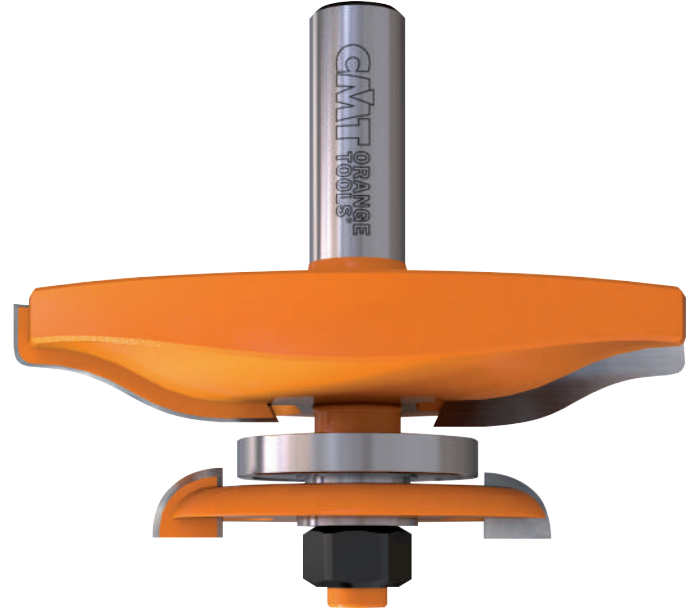
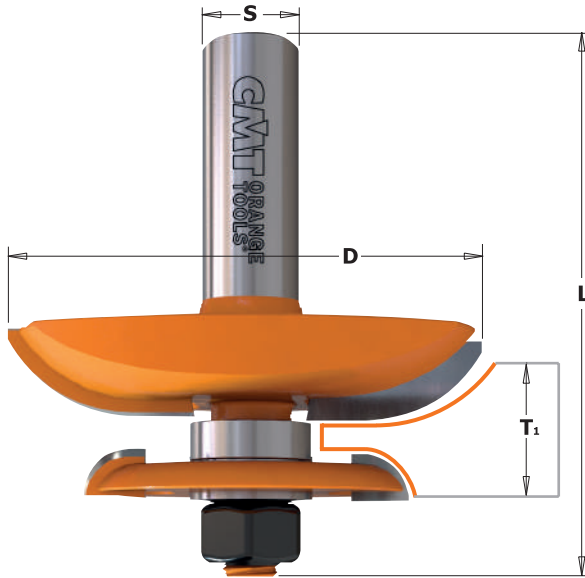

Drawing is 1:1 scale

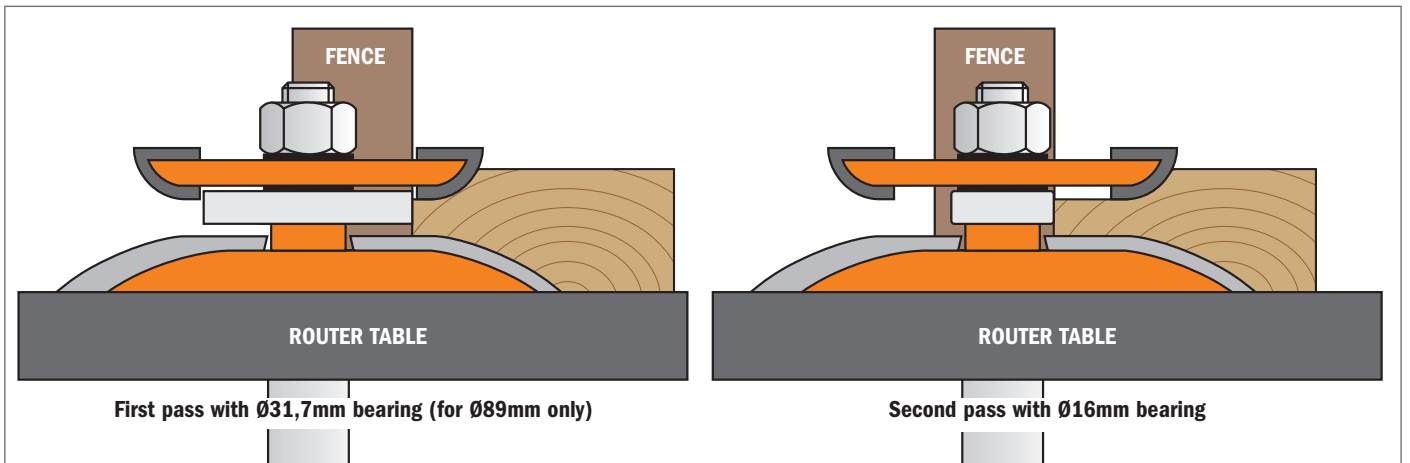

PROFILE	D mm	T ₁ mm	L mm		ORDER NO. S=Ø12mm	ORDER NO. S=Ø12,7mm
A	89	19 - 20,6	78,1	5	990.524.11	890.524.11
B	89	19 - 25,4	78,1	5	990.527.11	890.527.11
A ₁	63,5	11,1 - 17,5	70	5	990.534.11	890.534.11
B ₁	63,5	11,1 - 17,5	70	5	990.537.11	890.537.11

Spare parts

16mm	31,7mm		
822.007.11	791.025.00	791.033.00	990.020.00
822.007.11	791.025.00	791.033.00	990.020.00
822.010.11	791.025.00		990.020.00
822.010.11	791.025.00		990.020.00

Spare parts: 541.515.00 0,1mm spacer 541.518.00 1,0mm spacer
 541.516.00 0,3mm spacer 990.407.00 Shield conical

Stile & Panel Router Bits

8/970



These bits can be used for decorative work on solid wood panels and MDF materials. Use them in one pass or in combination with CMT's MDF panel bits for complex and intricate profiles. A simple approach for an elegant appearance.

Featuring large cutting diameters and available in the most popular profiles, these panel bits guarantee excellent performance.

PANEL BITS

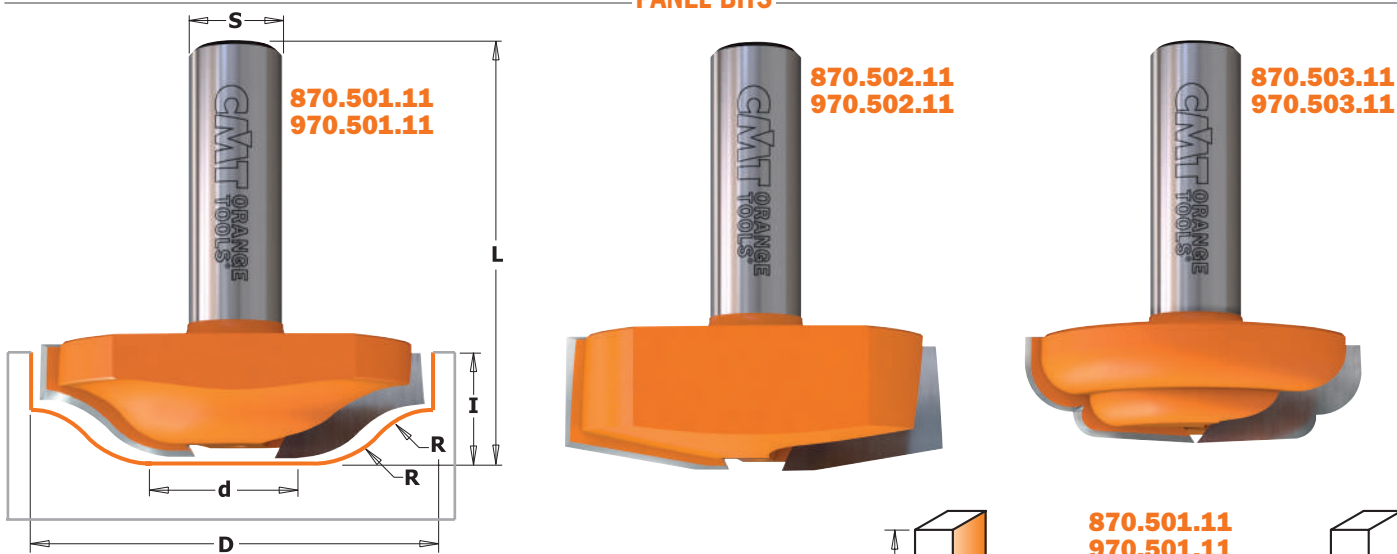

STILE BITS

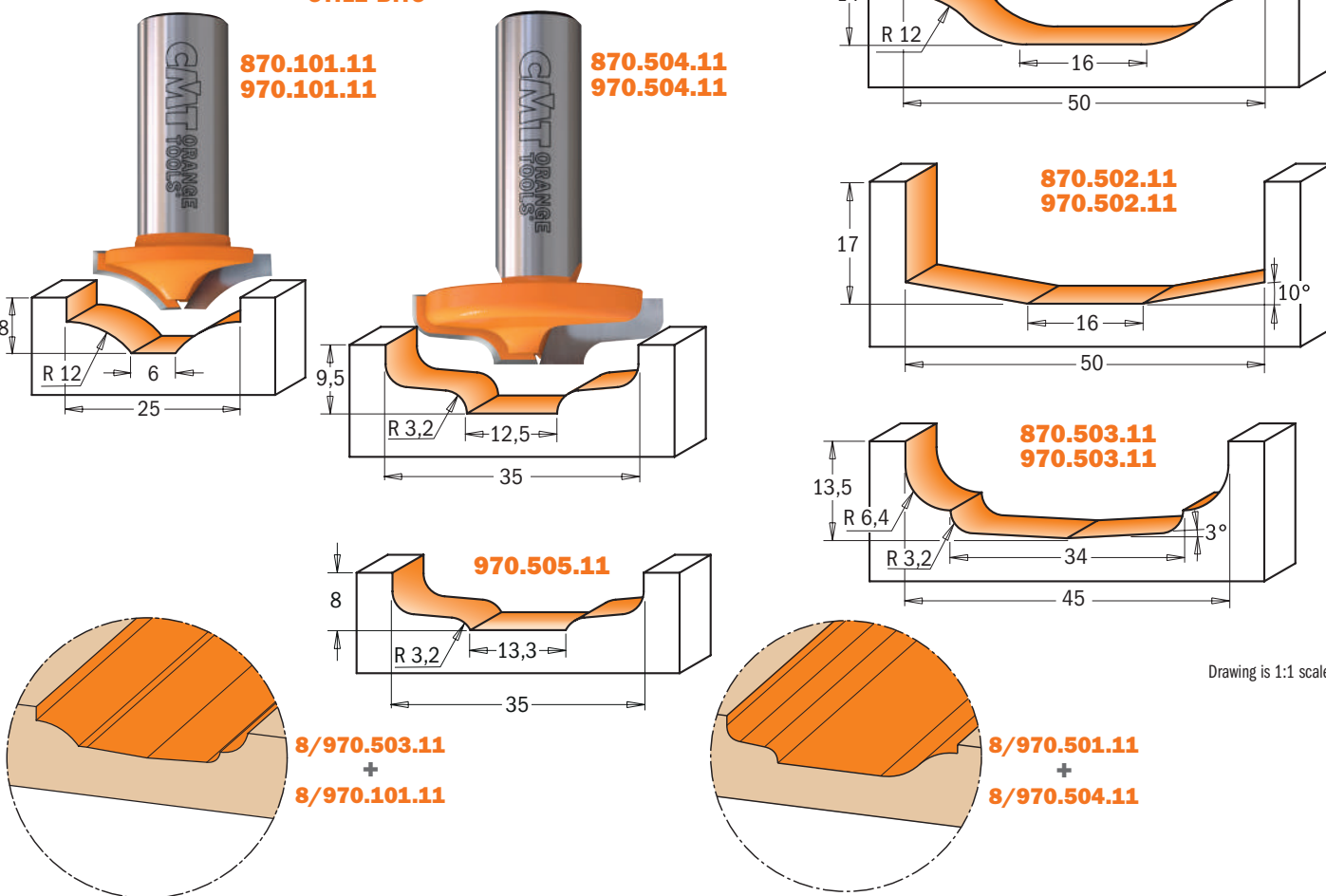

Drawing is 1:1 scale

D mm	d mm	l mm	R mm	A	L mm		ORDER NO. S=∅8mm	ORDER NO. S=∅12mm	ORDER NO. S=∅12,7mm
25	6	8	12		39,8	10	970.101.11		870.101.11
50	16	14	12		52,1	10		970.501.11	870.501.11
50	16	17		10°	55,1	10		970.502.11	870.502.11
45	34	13,5	3,2 - 6,4	3°	51,6	10		970.503.11	870.503.11
35	12,5	9,5	3,2		47,6	10		970.504.11	870.504.11
35	13,3	8	3,2		46	10		970.505.11	

3-Flute Slot Cutter for STRIPLOX® Mini

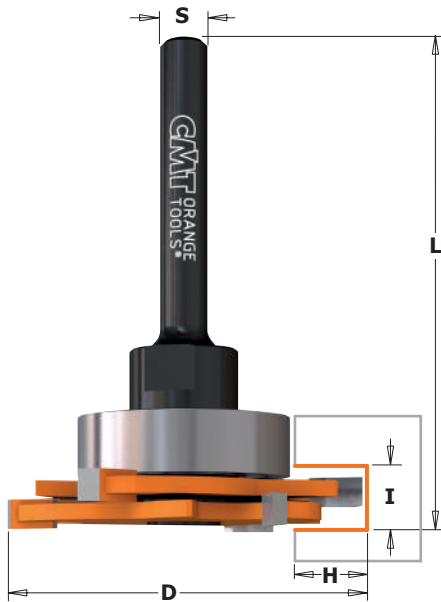

823.371

New CMT cutter for STRIPLOX® Mini connectors. These connectors are invisible joiners suited to everyday projects, custom cabinets, wood joints and any piece of cabinetry, furniture or design application. They produce a tight and strong joints either in a permanent or temporary structures making them perfectly suited for commercial, domestic and architectural furniture, kitchen, bathroom and wardrobe closets, cabinetry, commercial fit-outs plus many more applications.

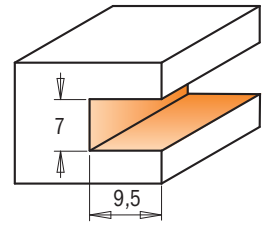

Drawing is 1:1 scale



I mm	D mm	H mm	L mm		ORDER NO.
7	47,6	9,5	65	10	823.371.11A

Spare parts

791.030.00	823.340.11	990.055.00	991.067.00

Spare parts: **541.515.00** 0,1mm spacer
541.516.00 0,3mm spacer
541.517.00 0,5mm spacer

Solid Surface - Counter-Top Trim Router Bits

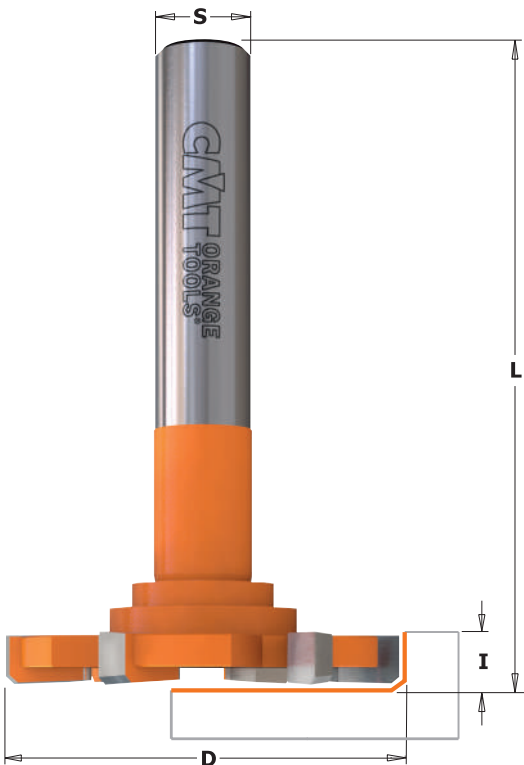

8/922.034-35

Create even shallow recesses in countertops with this 6-wing tool. The radiused cutting tips produce an edge that's super smooth to the touch and simple to clean. For use with handheld routers.

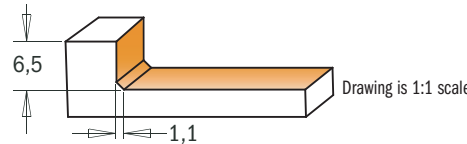

Drawing is 1:1 scale

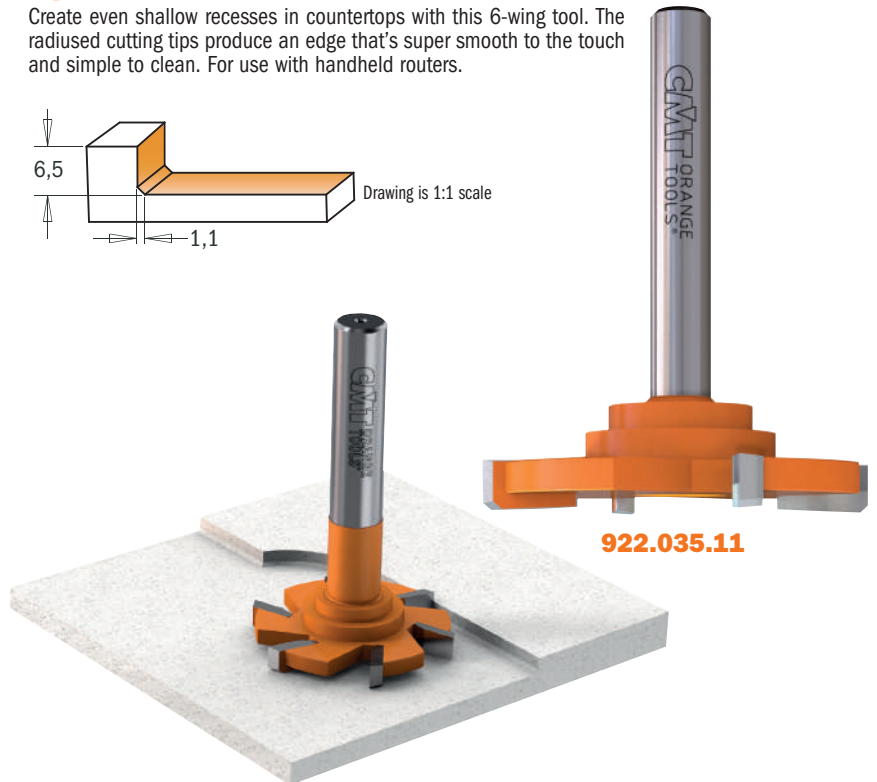

922.035.11

822/922.034.11

D mm	I mm	L mm	Z		ORDER NO.	ORDER NO.	ORDER NO.
52	6,5	65	4	5	922.035.11	S=Ø12mm	S=Ø12,7mm
52	6,5	83,5	6	5		922.034.11	822.034.11

Solid Surface - Rounding Over Bits



7/8/938 - 8/980.5

Use these bits to create traditional roundover edges on solid surface countertops. Equipped with a non-marring DELRIN® bearing to protect finished edges. For use on hand-held portable routers.

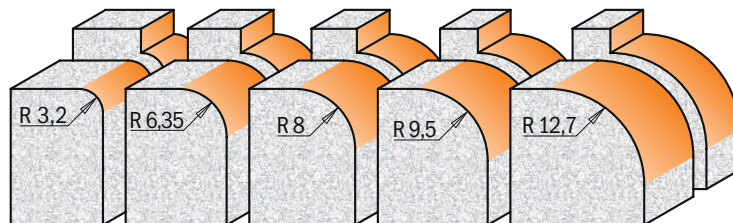
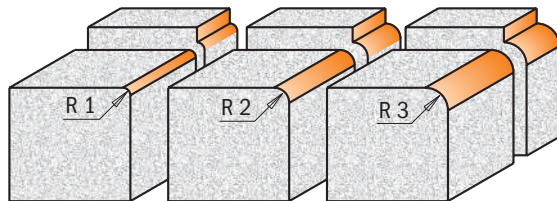
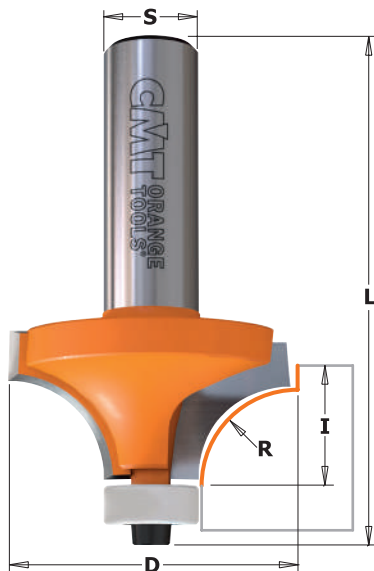

Drawing is 1:1 scale

APPLICATION
 WILSONART®
 GIBRALTAR®
 CORIAN®
 SURELL®
 FOUNTAINHEAD®
 AVONITE®
 FORMICA®
 Etc.

R mm	D mm	I mm	L mm		ORDER NO. S=Ø6mm	ORDER NO. S=Ø6,35mm	ORDER NO. S=Ø8mm	ORDER NO. S=Ø12mm	ORDER NO. S=Ø12,7mm
1	14,7	10	51	10		838.147.11	938.147.11		
2	16,7	12,7	52,5	10	738.167.11		938.167.11		
3	18,7	12,7	54	10	738.187.11		938.187.11		
3,2	19,05	12,7	59,5	10				980.501.11	880.501.11
6,35	25,4	12,7	59,5	10				980.502.11	880.502.11
8	28,7	15	62,5	10				980.505.11	880.505.11
9,5	31,75	14	61	10				980.503.11	880.503.11
12,7	38,1	19,05	66	10				980.504.11	880.504.11

Spare parts

990.422.00	791.044.00	990.058.00
990.422.00	791.044.00	990.058.00
990.422.00	791.044.00	990.058.00
990.422.00	791.044.00	990.058.00
990.422.00	791.044.00	990.058.00
990.422.00	791.044.00	990.058.00
990.422.00	791.044.00	990.058.00
990.422.00	791.044.00	990.058.00
990.422.00	791.044.00	990.058.00

Spare parts: **991.057.00** 3/32" hex key

Solid Surface - Decorative Edge Profile Bits



8/980.521

Create elegant countertops with flawless results. Features a non-marring DELRIN® bearing to protect the finished edges. For use on hand-held portable routers.

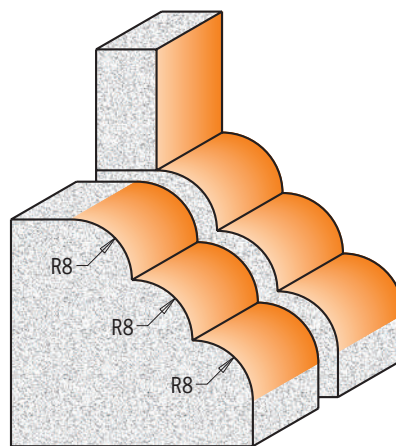
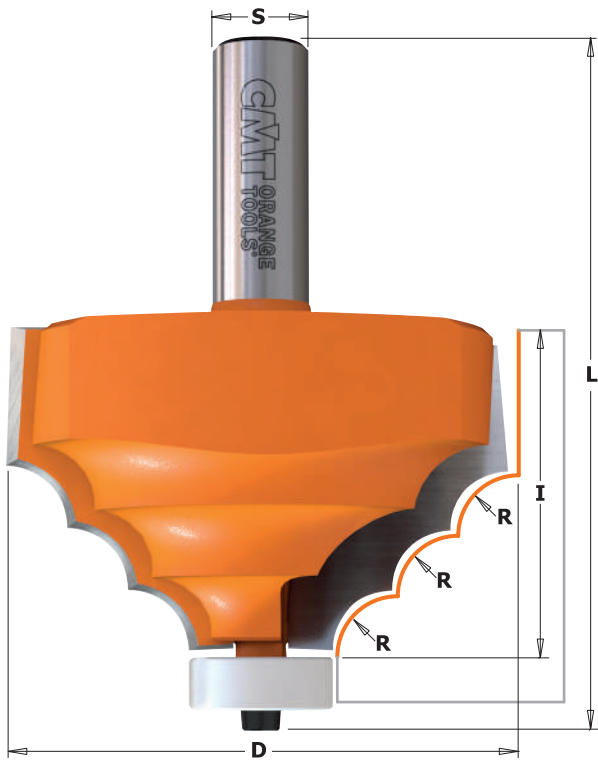

Drawing is 1:1 scale

APPLICATION
 WILSONART®
 GIBRALTAR®
 CORIAN®
 SURELL®
 FOUNTAINHEAD®
 AVONITE®
 FORMICA®
 Etc.

D mm	I mm	R mm	L mm		ORDER NO. S=Ø12mm	ORDER NO. S=Ø12,7mm
66,7	41,3	8	89,8	5	980.521.11	880.521.11

Spare parts

791.046.00	990.058.00	991.057.00

Solid Surface - Rounding Over Bowl Bits

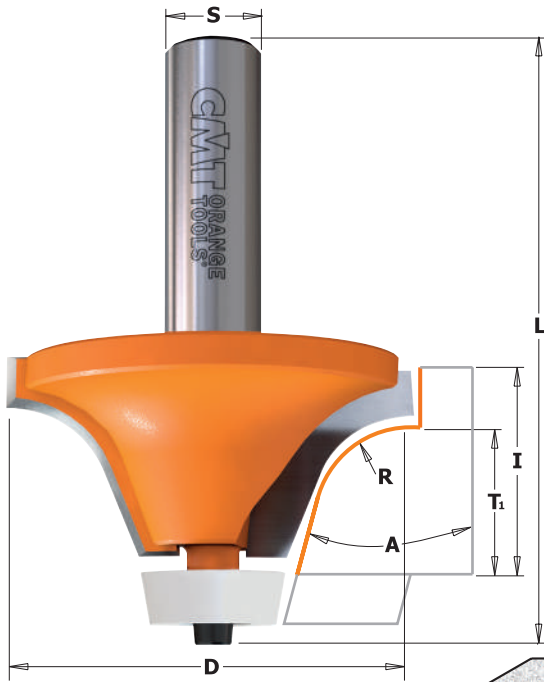

8/966.601/602
8/980.541



These bits are the best tool for rounding over and trimming countertop edges after the bowl is mounted. Can be used together with the CMT 8/980.551.11 bevel cutter for a flush cut-out between the countertop and the installed undermount bowl. For use on hand-held routers. Features a non-marring DELRIN® bearing to protect the finished edges as well as surfaces.

APPLICATION
WILSONART®
GIBRALTAR®
CORIAN®
SURELL®
FOUNTAINHEAD®
AVONITE®
FORMICA®
Etc.

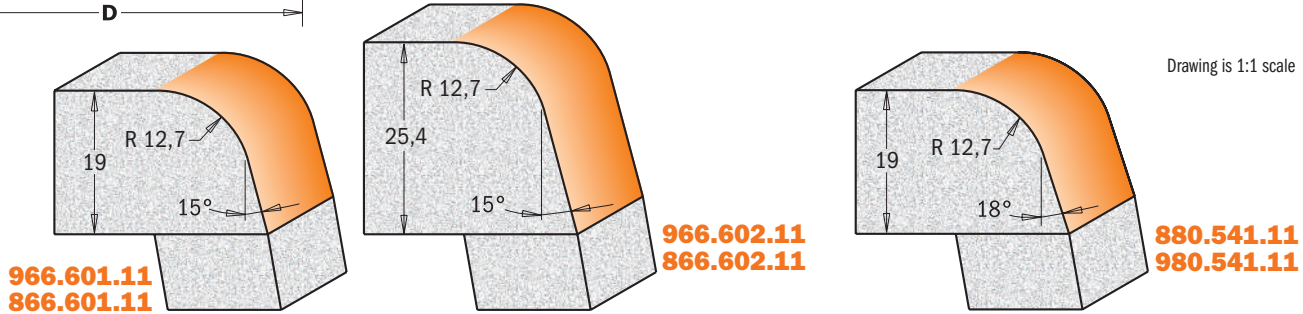

966.601.11
866.601.11

966.602.11
866.602.11

880.541.11
980.541.11

Drawing is 1:1 scale

A	D mm	T ₁ mm	I mm	R mm	L mm		ORDER NO. S=Ø12mm	ORDER NO. S=Ø12,7mm
15°	50,8	19	25,4	12,7	74,9	10	966.601.11	866.601.11
15°	50,8	25,4	31,75	12,7	81,3	10	966.602.11	866.602.11
18°	54	19	25,4	12,7	78,1	10	980.541.11	880.541.11

Spare parts

791.041.00	990.058.00	991.057.00
791.041.00	990.058.00	991.057.00
791.041.00	990.058.00	991.057.00

Solid Surface - Rounding Over Bowl Bit (ogee profile)

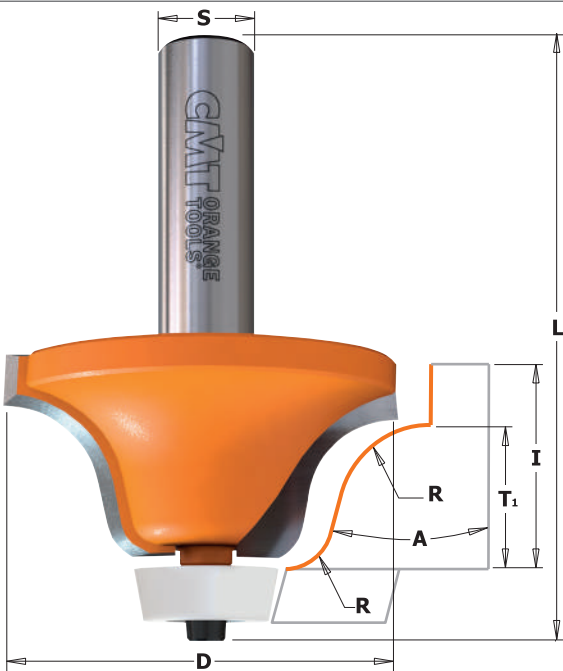

8/980.542



These bits roundover and trim the countertop edges after the bowl is mounted. Can be used with the CMT 8/980.551.11 bevel cutter for a flush cut-out between the countertop and installed undermount bowl. For use on hand-held portable routers. Features a non-marring DELRIN® bearing to protect the finished edges.

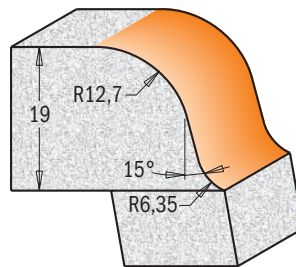

Drawing is 1:1 scale

APPLICATION
WILSONART®
GIBRALTAR®
CORIAN®
SURELL®
FOUNTAINHEAD®
AVONITE®
FORMICA®
Etc.

A	D mm	T ₁ mm	I mm	R mm	L mm		ORDER NO. S=Ø12mm	ORDER NO. S=Ø12,7mm
15°	54	19	25,4	6,35-12,7	77,6	10	980.542.11	880.542.11

Spare parts

791.041.00	990.058.00	991.057.00

Solid Surface - Bevel Bowl Bits

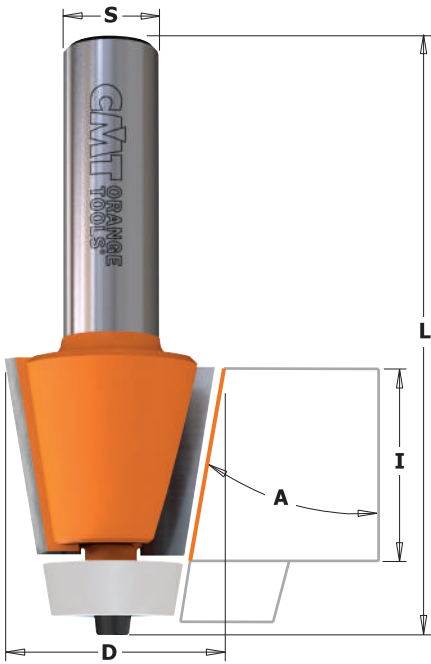

8/966.501 - 8/980.551



These bits are designed for undermount applications joining the countertops and sink bowls with a beveled edge. Can be used with the 8/980.541.11 and 8/980.542.11 for complete undermount applications. For use on hand-held routers. Features a non-marring DELRIN® bearing to protect the finished edges and surfaces.

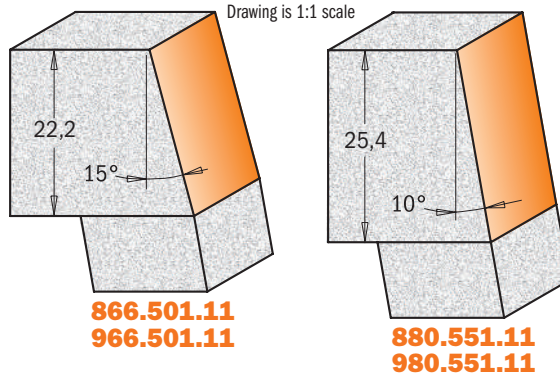

APPLICATION
 WILSONART®
 GIBRALTAR®
 CORIAN®
 SURELL®
 FOUNTAINHEAD®
 AVONITE®
 FORMICA®
 Etc.

A	D mm	I mm	L mm		ORDER NO. S=∅12mm	ORDER NO. S=∅12,7mm
15°	31,7	22,2	72	10	966.501.11	866.501.11
10°	28,5	25,4	77	10	980.551.11	880.551.11

Spare parts

791.041.00	990.058.00	991.057.00
791.041.00	990.058.00	991.057.00

Solid Surface - Bevel Bit



8/981.521



Edge profile bit designed to create a 15° beveled edge on solid surface countertops. Can also be used for European type topmount installation with sinks and bowls. For use on hand-held portable and table routers.

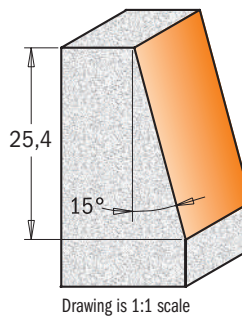

APPLICATION
 WILSONART®
 GIBRALTAR®
 CORIAN®
 SURELL®
 FOUNTAINHEAD®
 AVONITE®
 FORMICA®
 Etc.

D mm	d mm	I mm	A	L mm		ORDER NO. S=∅12mm	ORDER NO. S=∅12,7mm
23	9,52	25,4	15°	63,5	10	981.521.11	881.521.11

Solid Surface - Cut & Plug Repair Set



Download the instructions

9/881.541



These special carbide-tipped bits work best on solid surfaces or when repairing damaged surfaces. One bit creates the plug, then the other bit easily carves out the hole. Your surfaces will look like new again!
For use with hand-held routers or CNC machines.

APPLICATION

- WILSONART®
- GIBRALTAR®
- CORIAN®
- SURELL®
- FOUNTAINHEAD®
- AVONITE®
- FORMICA®
- Etc.

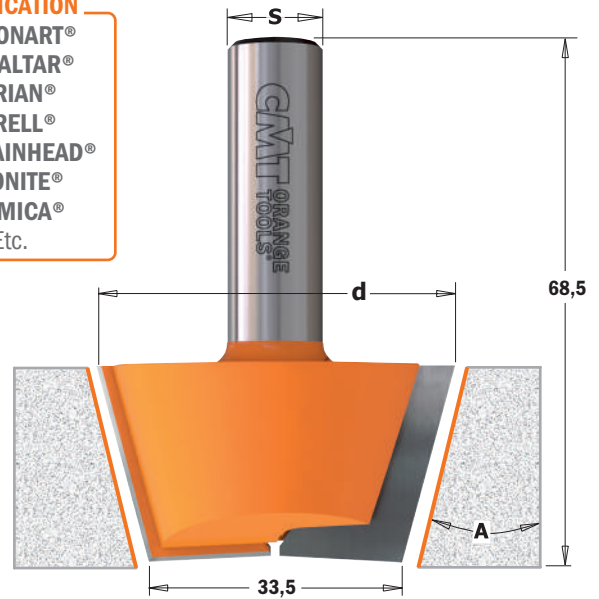
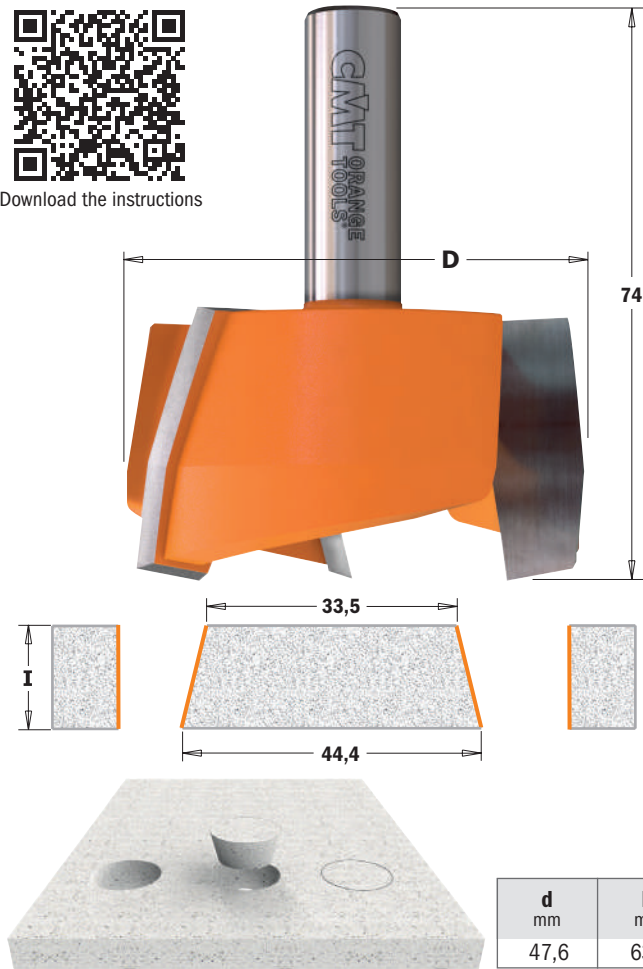

d mm	D mm	I mm	A	L mm		ORDER NO. S=Ø12mm	ORDER NO. S=Ø12,7mm
47,6	63,5	20	15°	68,5-74	5	981.541.11	881.541.11

4-Wing Cut Out Slot Cutters for Solid Surfaces



8/922.033B

This bit features two tungsten carbide-tipped cutting edges for carving out solid surface undermount bowls in composite. For use on hand-held routers. Bit also equipped with a non-marring DELRIN® bearing to protect your surfaces.

APPLICATION

- WILSONART®
- GIBRALTAR®
- CORIAN®
- SURELL®
- FOUNTAINHEAD®
- AVONITE®
- FORMICA®
- Etc.

Drawing is 1:1 scale

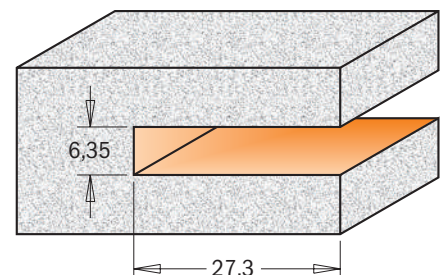
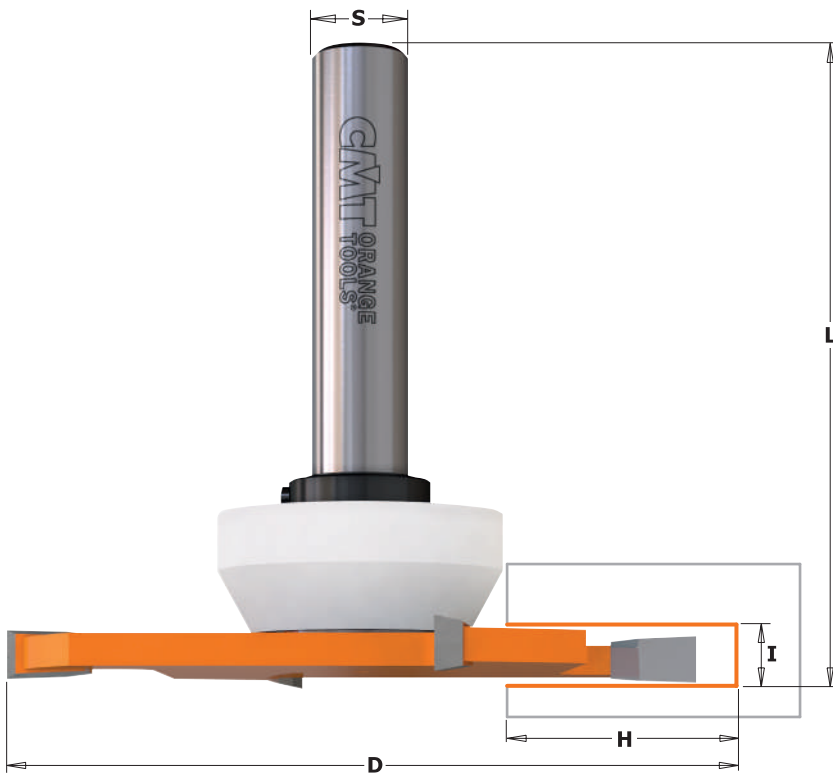

D mm	I mm	H mm	L mm		ORDER NO. S=Ø12mm	ORDER NO. S=Ø12,7mm
92	6,35	27,3	82,5	5	922.033.11B	822.033.11B

Spare parts

541.553.00	791.047.00	541.002.00	991.056.00

Solid Surface - No-Drip Bit



8/981.501

This bit is designed to create "no-drip" edges on kitchen and vanity countertops in one simple step. Designed for hand-held portable routers on applications where a guide bearing cannot be used. This one bit will cut both the outer and inner profiles creating a slightly raised edge, controlling spilled liquids.

APPLICATION
WILSONART®
GIBRALTAR®
CORIAN®
SURELL®
FOUNTAINHEAD®
AVONITE®
FORMICA®
 Etc.

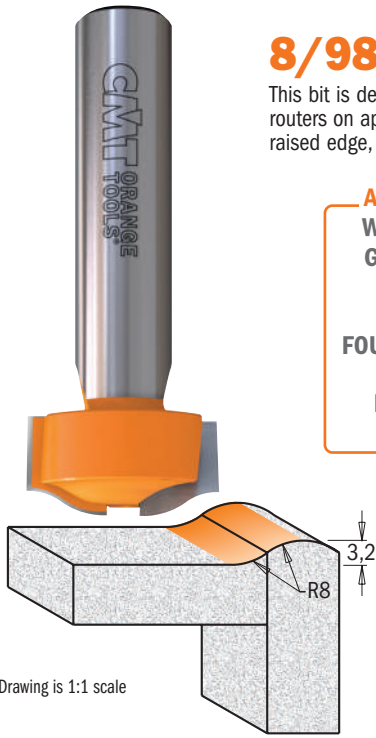
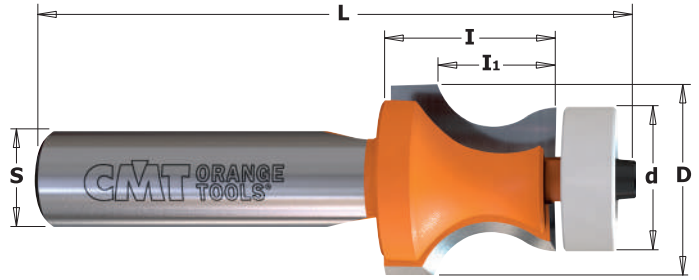

Drawing is 1:1 scale

8/980.531

This bit creates strong and reliable joints in a variety of composites thanks to greater surface area for applying glue.

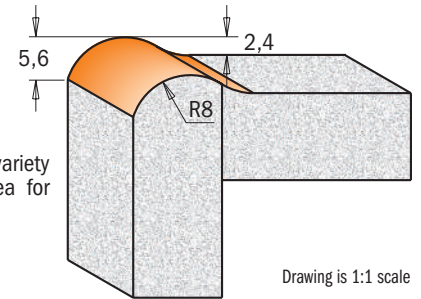

Drawing is 1:1 scale

D mm	d mm	I mm	I ₁ mm	R mm	L mm		ORDER NO. S=∅12mm	ORDER NO. S=∅12,7mm
25,4		12,7	3,2	8	63,5	10	981.501.11	881.501.11
25,4	19	22,2	15,87	8	77	10	980.531.11	880.531.11

Spare parts

791.046.00	990.058.00	991.057.00

Solid Surface - Wavy Joint Bit

8/981.531

These bits are ideal for making strong joints on any solid surface, thanks to a wider surface area for glue application.



APPLICATION
WILSONART®
GIBRALTAR®
CORIAN®
SURELL®
FOUNTAINHEAD®
AVONITE®
FORMICA®
 Etc.

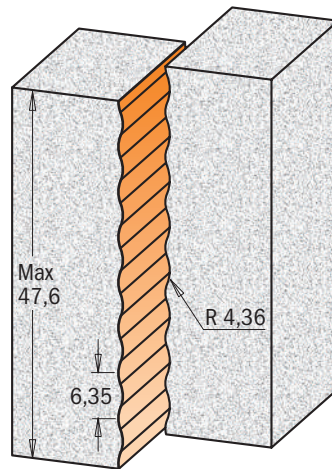

Drawing is 1:1 scale

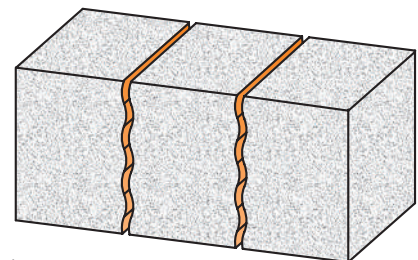

D mm	I mm	R mm	L mm		ORDER NO. S=∅12mm	ORDER NO. S=∅12,7mm
15,87	51,5	4,36	89	10	981.531.11	881.531.11

Solid Surface - Drainboard Bits

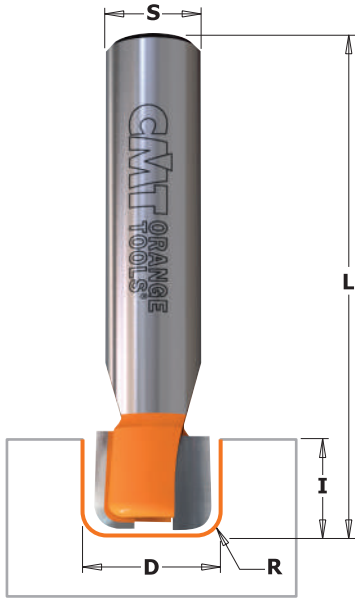

8/981.511-512

This bit is ideal for creating custom drainboard patterns in solid surface countertops. For use on hand-held portable routers.



APPLICATION

- WILSONART®
- GIBRALTAR®
- CORIAN®
- SURELL®
- FOUNTAINHEAD®
- AVONITE®
- FORMICA®
- Etc.

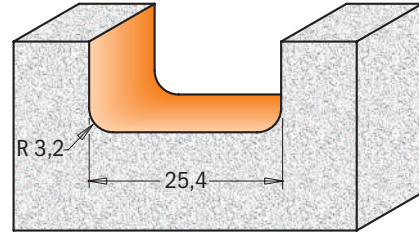
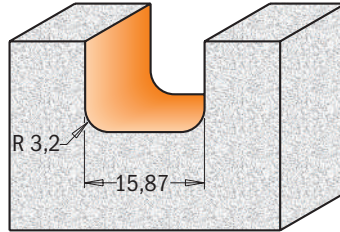

Drawing is 1:1 scale

D mm	I mm	R mm	L mm		ORDER NO. S=Ø12mm	ORDER NO. S=Ø12,7mm
15,87	12,7	3,2	63,5	10	981.511.11	881.511.11
25,4	12,7	3,2	69,8	10	981.512.11	881.512.11

Solid Surface - Inlay Bits

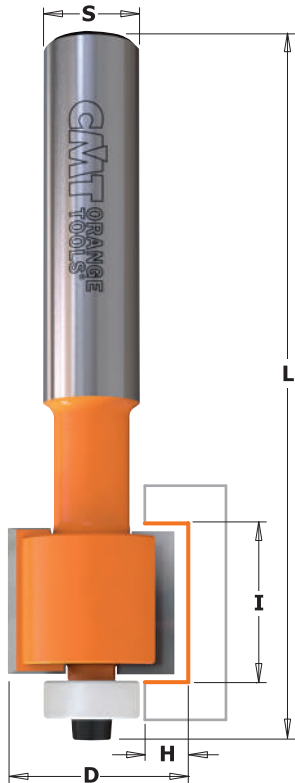

8/980.511-512-513

Add a decorative inlay to solid surface countertops in composite. Equipped with a non-marring DELRIN® bearing to protect the finished edges. For use on hand-held portable and table routers.



APPLICATION

- WILSONART®
- GIBRALTAR®
- CORIAN®
- SURELL®
- FOUNTAINHEAD®
- AVONITE®
- FORMICA®
- Etc.

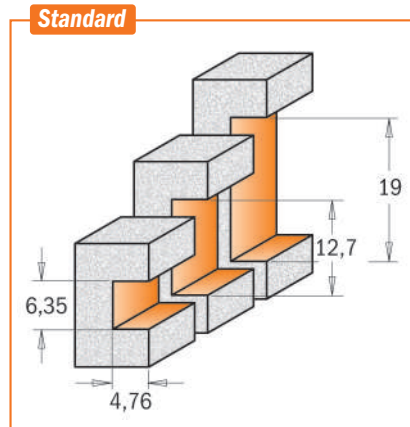

Drawing is 1:1 scale

Optional

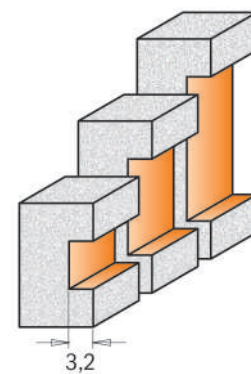

optional with bearing 791.045.00

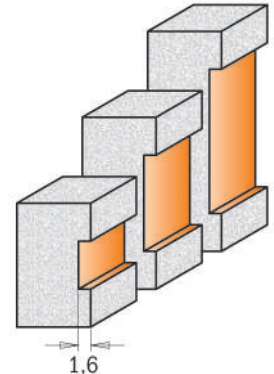

optional with bearing 791.046.00

D mm	I mm	H mm	L mm		ORDER NO. S=Ø12mm	ORDER NO. S=Ø12,7mm	Spare parts		
22,2	6,35	4,76	77	10	980.511.11	880.511.11			
22,2	12,7	4,76	90	10	980.512.11	880.512.11	791.044.00	990.058.00	991.057.00
22,2	19,05	4,76	90	10	980.513.11	880.513.11	791.044.00	990.058.00	991.057.00

Solid Surface - Sink & Trim Bits



8/980.57

Trim a sink cut-out flush with the bowl in stages using these “overhang” and flush trim bits. The DELRIN® bearings are tapered to match the slope of the bowl’s side. A first pass with the overhang bit cleans the cut-out edge, leaving a slight overhang on the underside of the counter. A second pass with the flush-trim bit completes the operation. Made from super micrograin carbide for guaranteed longer life!

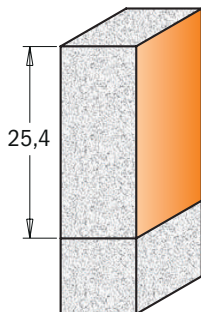

880.571.11
980.571.11

Drawing is 1:1 scale

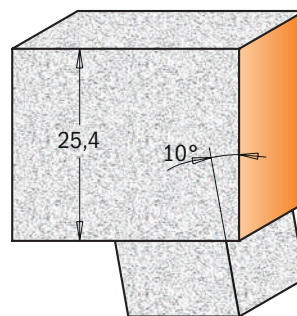

880.572.11
980.572.11



APPLICATION

WILSONART®
GIBRALTAR®
CORIAN®
SURELL®
FOUNTAINHEAD®
AVONITE®
FORMICA®
Etc.



D mm	I mm	A	L mm		ORDER NO. S=Ø12mm	ORDER NO. S=Ø12,7mm
19,05	25,4		78	10	980.571.11	880.571.11
22	25,4	10°	78	10	980.572.11	880.572.11

Spare parts

791.046.00	990.058.00	991.057.00
791.048.00	990.058.00	991.057.00

Solid Surface - Sink & Trim Bits with Insert Knives - LONG LIFE



8/980.56

Trim a sink cut-out flush with the bowl in stages using these “overhang” and flush trim bits. The DELRIN® bearings are tapered to match the slope of the bowl’s side. A first pass with the overhang bit **8/980.562.11** cleans the cut-out edge, leaving a slight overhang on the underside of the counter. A second pass with the flush-trim bit **8/980.561.11** completes the operation. Knives made from super micrograin carbide and sharpened on both sides guarantee longer life!

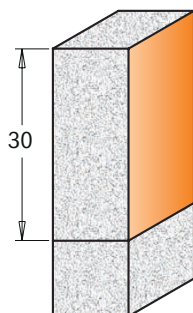

880.561.11
980.561.11

Drawing is 1:1 scale

CORRECT KNIFE POSITIONING

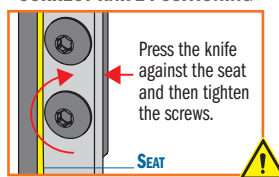

APPLICATION

WILSONART®
GIBRALTAR®
CORIAN®
SURELL®
FOUNTAINHEAD®
AVONITE®
FORMICA®
Etc.



880.562.11
980.562.11

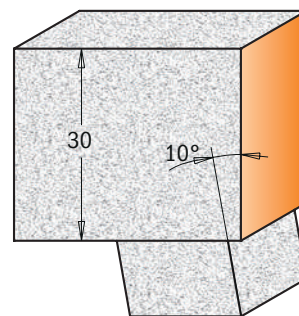

Drawing is 1:1 scale

SAFETY TIPS

The **TW-006** Torque Screwdriver is recommended for the proper fastening of screws (see page 413).

D mm	I mm	A	L mm		ORDER NO. S=Ø12mm	ORDER NO. S=Ø12,7mm
19,05	30		83	10	980.561.11	880.561.11
22	30	10°	83	10	980.562.11	880.562.11

Spare parts

790.300.03	990.075.00	991.061.00	791.046.00	990.058.00	991.057.00
790.300.03	990.075.00	991.061.00	791.048.00	990.058.00	991.057.00

26 Piece Router Bit Set



900.003

Find a whole workshop in this practical 26 piece router bit set! An endless selection of tools to express your woodworking creativity! Every cutting tool is made from the highest quality tungsten carbide and features our trademarked P.T.F.E. orange coating. Comes with a snap-lock case for safe storage!



DESCRIPTION	Box Icon	ORDER NO. S=Ø8mm
26 Piece Router Bit Set	1	900.003.00

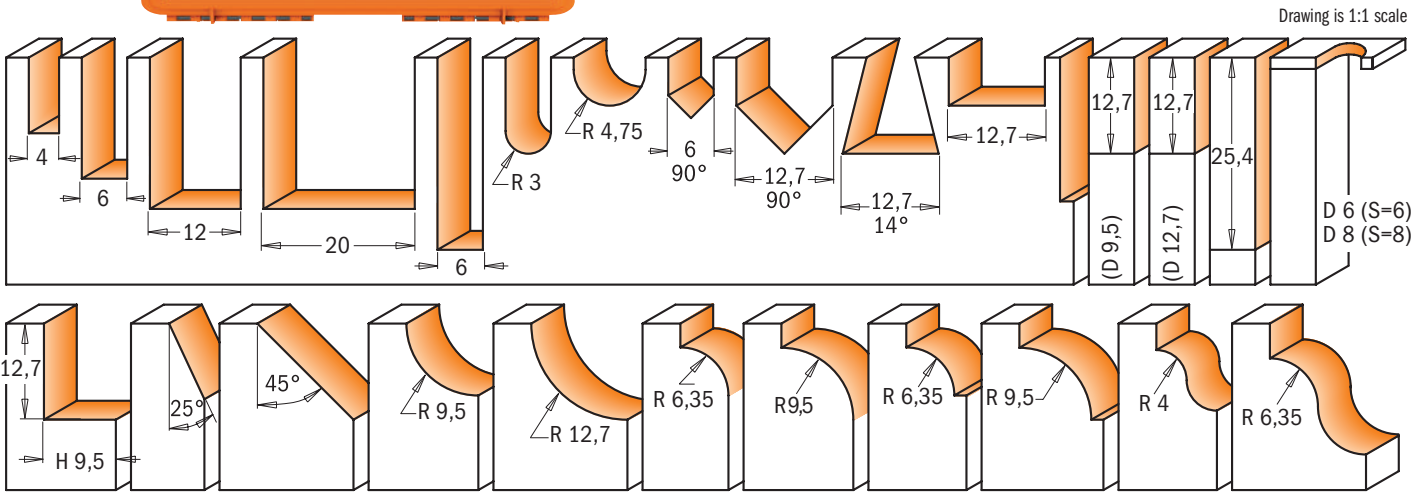

15 Piece Router Bit Set



8/900.001

CMT's 15 piece bit router bit set is the perfect companion for the professional craftsman. This set offers a selection of organized and ready-to-use straight and profile bits. Added value for any woodworker! Each bit is made with micrograin tungsten carbide and coated with orange non-stick P.T.F.E. Comes with a snap-lock case for safe storage!



DESCRIPTION	Box Icon	ORDER NO. S=Ø6,35mm	ORDER NO. S=Ø8mm
15 Piece Router Bit Set	1	800.001.00	900.001.00

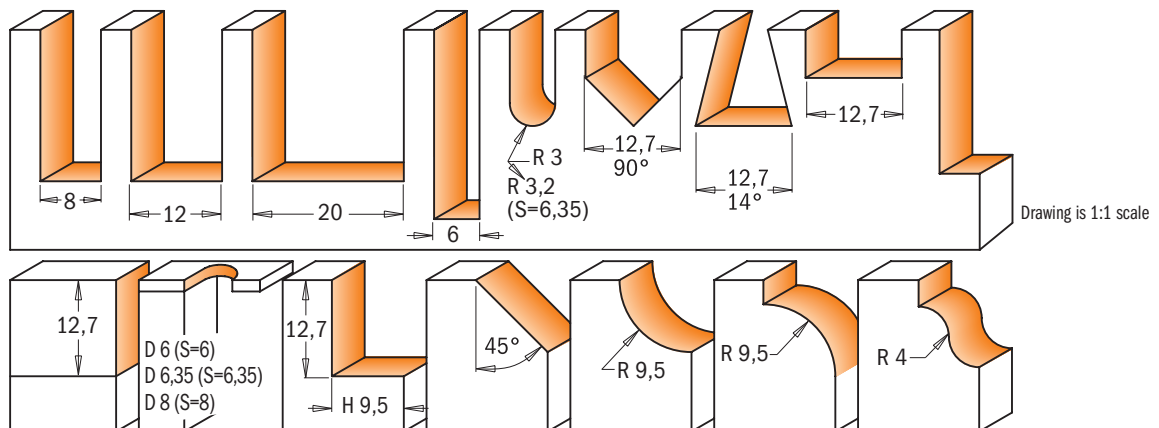

12 Piece Router Bit Set



800.503



CMT's 12 most frequently used 6.35mm shank router bits assembled in a compact and attractive case for your convenience! The perfect case for any professional woodworker! Comes with a snap-lock case for safe storage!



DESCRIPTION		ORDER NO. S=Ø6,35mm
12 Piece Router Bit Set	1	800.503.11

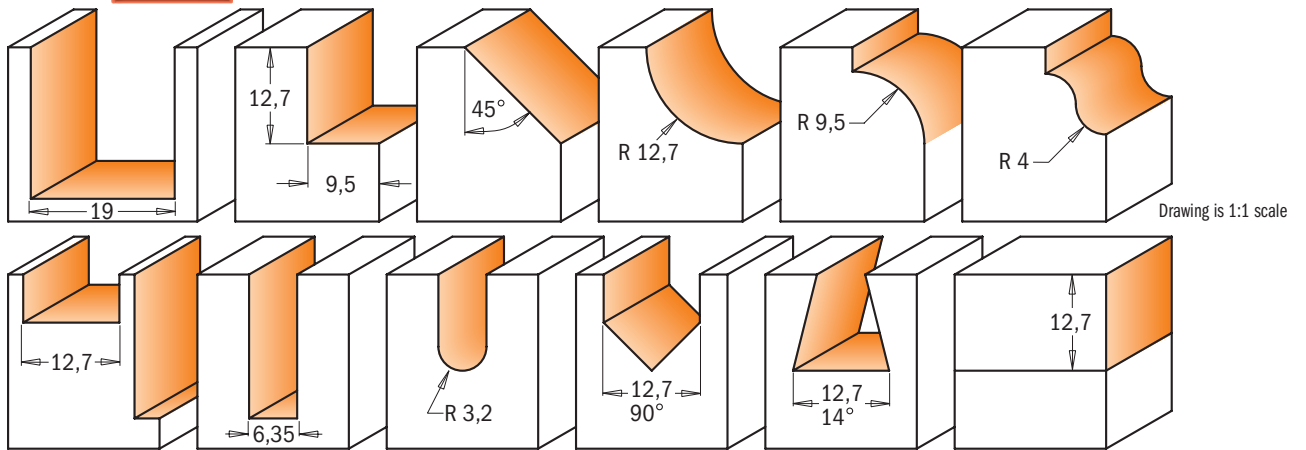

13 Piece Router Bit Set



800.505



CMT's 13 most frequently used 12.7mm shank router bits assembled in a compact and attractive case for your convenience! Unique design that comes with a snap-lock case for safe storage!



DESCRIPTION		ORDER NO. S=Ø12,7mm
13 Piece Router Bit Set	1	800.505.11

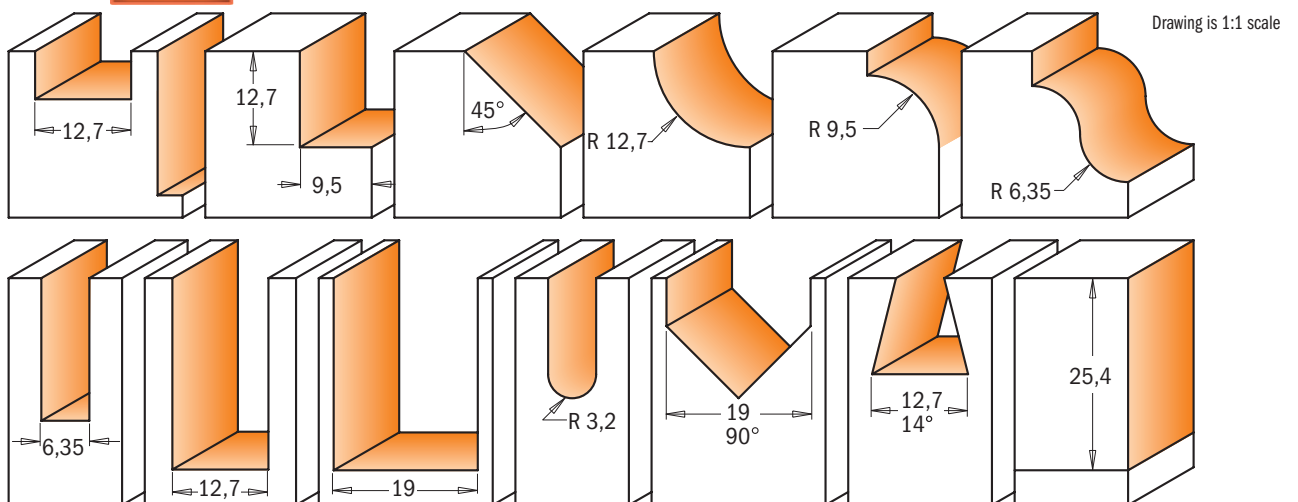

Divided Light Door Set



800.525 - 900.025



Build authentic divided light doors for fine furniture and cabinets with these 3 piece sets. They include a stuck bit to cut the decorative ovolo profile on the frame edges, a cope to shape the mating profile on the ends of the stock, and a rabbeting bit to cut the recess for the glass. Thanks to the guide bearings, you can also create arches on curved frames. The unique design of the cope bit allows you to use full-length tenons to create strong, authentic mortise-and-tenon joinery. As the stock is coped, the tenon passes over the bit. These sets are designed for 22,2mm wide bars such as those on corner cupboard doors.

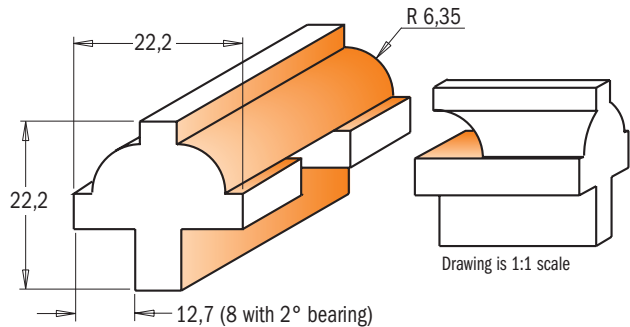
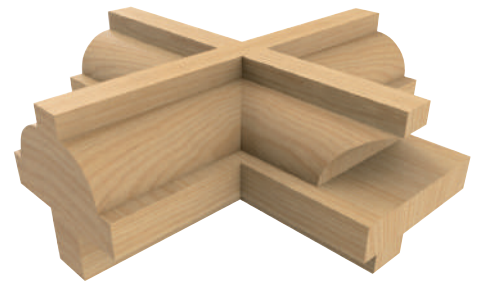

DESCRIPTION		ORDER NO. S=Ø8mm	ORDER NO. S=Ø12,7mm
Divided Light Door Set	1	900.025.11	800.525.11

Glass Panel Set



8/955.803



CMT's unique stile and rail router bit sets allow you to produce glass panel doors by using a rubber panel retainer to secure the glass in a 3,2mm slot cut into the frames. These bits work the same as other CMT stile and rail sets, but they leave you with a square rabbet on the inside of your door for installing the glass panel. Available in 12mm and 12,7mm shanks.

DESCRIPTION		ORDER NO. S=Ø12mm	ORDER NO. S=Ø12,7mm
Glass Panel Set	1	955.803.11	855.803.11

GLASS PANEL RETAINERS

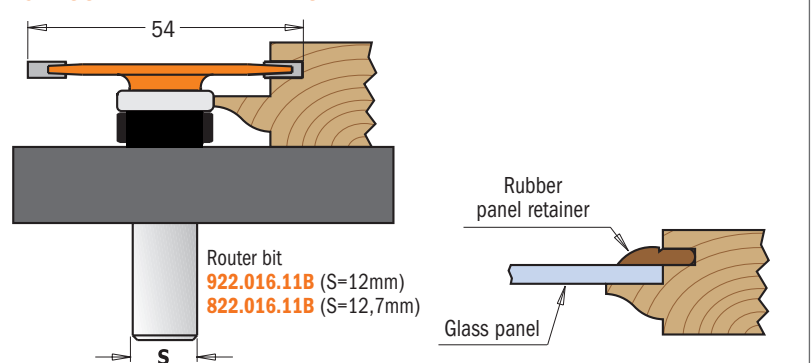

HERE'S HOW IT WORKS:

Mill the cope and pattern cuts first, then use the slot cutter to cut the groove for the rubber panel retainer. The edge of the pattern cut will ride on the bearing of the slot cutter bit. When you cut the slot in the rails you can cut the slot the full length of the stock. When you cut the slot in the stiles you need to set up reference points to stop and start the cuts so they are hidden from view on the top and bottom of the doors.

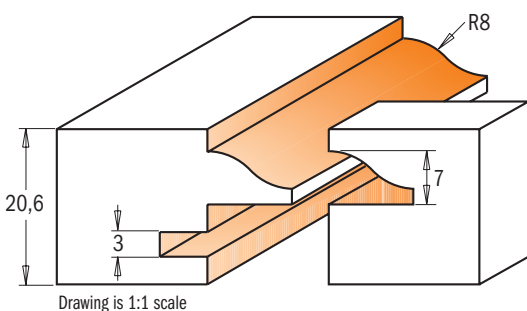

Entry & Interior Door Router Bit Set



8/900.527

This is a multifunctional set for door and furniture makers, building entry or passage doors and furniture tenons. The tenon cutter included in the set, produces a beefy 27mm long tenon. As an extra bonus, the tenon cutter can be used for making furniture requiring tenons anywhere from 9.5mm to 16mm in thickness.



**ENTRY & INTERIOR DOOR CONSTRUCTION
EASY AS 1, 2, 3!**

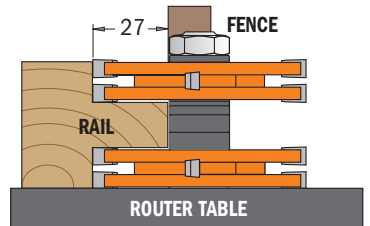

STEP 1. Cut the tenon into the rails

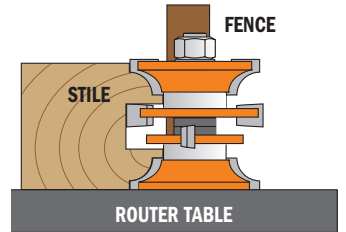

STEP 2. Cut the groove and door profile in pieces.

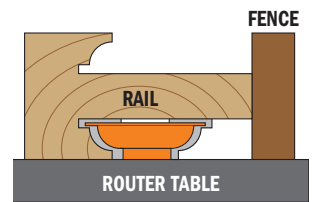

STEP 3. Undercut the tenons to cope the ends of the rails.

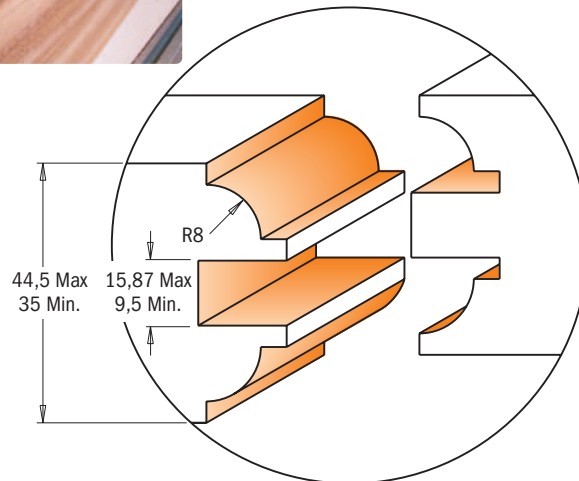

DESCRIPTION		ORDER NO. S=Ø12mm	ORDER NO. S=Ø12,7mm
3 Piece Entry & Interior Door Router Bit Set	1	900.527.11	800.527.11

2 Piece Entry Door Router Bit Set

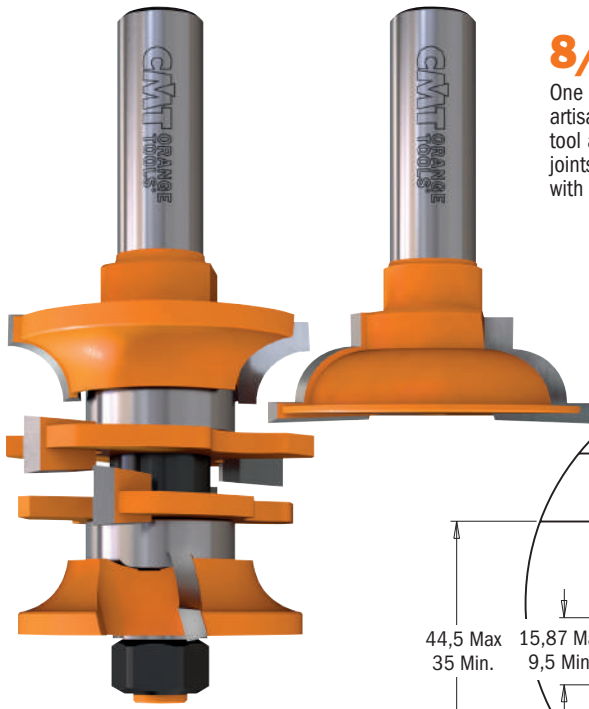

8/955.806

One of the more popular bits among both artisans and professional carpenters, this tool allows you to create tongue and-groove joints and produce entry and passage doors with minimal effort. Incredible versatility!

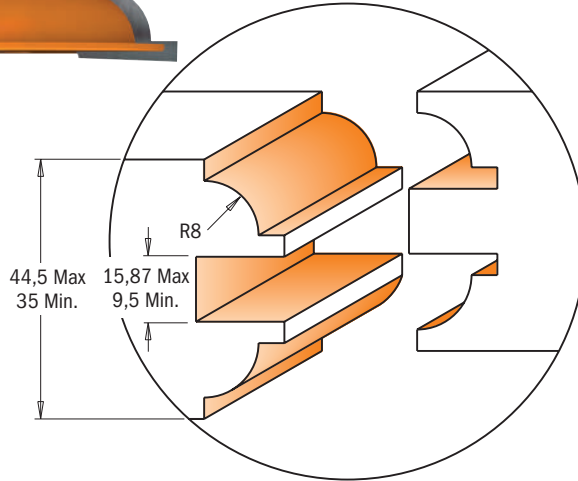

ENTRY & INTERIOR DOOR CONSTRUCTION

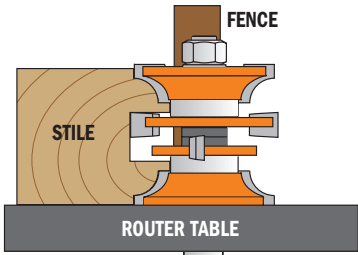

APPLICATION 1: cut the groove and the door profile in all pieces.

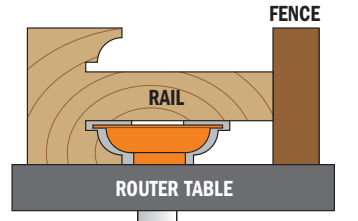

APPLICATION 2: undercut the tenon to cope the ends of the rails.

D mm	I mm		ORDER NO. S=Ø12mm	ORDER NO. S=Ø12,7mm
44,5-48	35-44,5	5	955.806.11	855.806.11

Spare parts

791.005.00	822.021.11A	822.021.11B	822.022.11	541.515.00	541.516.00	541.500.00	990.020.00

Tenon Cutting Router Bits

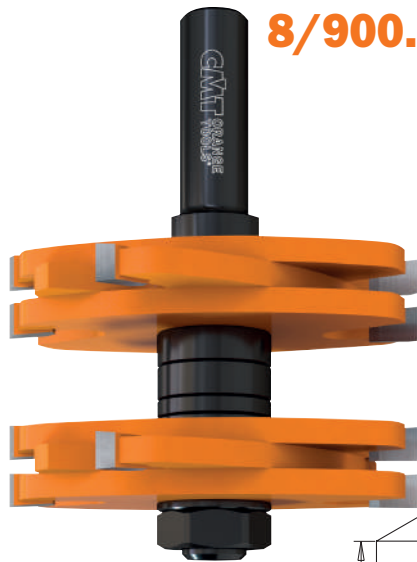

8/900.628



8/900.627



CMT's tenon cutting router bit will produce the most perfect fitting tenons in every board you cut, even if the boards vary in thickness. Simply set the distance between the cutters using the included spacers, and you can easily cut tenons from 4,76mm to 9,5mm thick, and up to 27mm long. This simple-to-use router bit takes the mystery out of tenon-to-mortise fit required for high quality joinery.

Maximum speed
MAX RPM 12.000

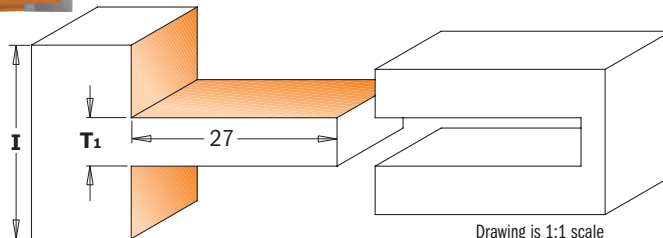

8-900.627

T1	Spacer (mm)		
	6,35mm	3,2mm	1,6mm
4,76mm	1	0	0
6,35mm	1	0	1
8mm	1	1	0
9,5mm	1	1	1

D mm	I mm	T1 mm		ORDER NO. S=Ø12mm	ORDER NO. S=Ø12,7mm
75	34,9	4,76-9,5	5	900.627.11	800.627.11
75	34,9	4,76-9,5	5	900.628.11	800.628.11
75	44,5	9,5-15,8	5	900.628.11	800.628.11
75	44,5	9,5-15,8	5	900.628.11	800.628.11

Spare parts

924.134.00	822.020.11	541.526.00	541.520.00	541.521.00	541.522.00	541.523.00	990.022.00
824.134.00	822.020.11	541.526.00	541.520.00	541.521.00	541.522.00	541.523.00	990.022.00
924.135.00	822.020.11	541.526.00	541.520.00	541.521.00	541.522.00	541.523.00	990.022.00
824.135.00	822.020.11	541.526.00	541.520.00	541.521.00	541.522.00	541.523.00	990.022.00

The Cabinetmaking Set

800.515 - 800.520



Available with raised panel bits in two different profiles, these sets feature six router bits for making arched raised panel doors and professional drawer fronts. These sets include:

OGEE RAIL & STILE BITS: these two perfectly matched tools will eliminate the frustration of setting up reversible cutters. The stile bits also feature shear angles for neater cuts.

RAISED PANEL BIT WITH BACKCUTTER: this 88,9mm diameter bit features a backcutter for milling both the front and the back on the panel in a single cut. We recommend using a 31mm diameter bearing to work safely in two shallow passes.

SUPER-DUTY FLUSH TRIM BIT: this 19mm diameter bit gives you a superior cut with minimal chipping, even on end grain.

OGEE DOOR EDGE BIT: a subtle cove followed by a subtle roundover adds an elegant touch to your door edge.

DRAWER FRONT BIT: this bit makes a mini-raised panel cut on the outside edges of your drawer fronts.

DESCRIPTION	Box	ORDER NO. S=Ø12,7mm
The Cabinetmaking Set - Profile A (6 pcs. HW)	1	800.515.11
The Cabinetmaking Set - Profile B (6 pcs. HW)	1	800.520.11

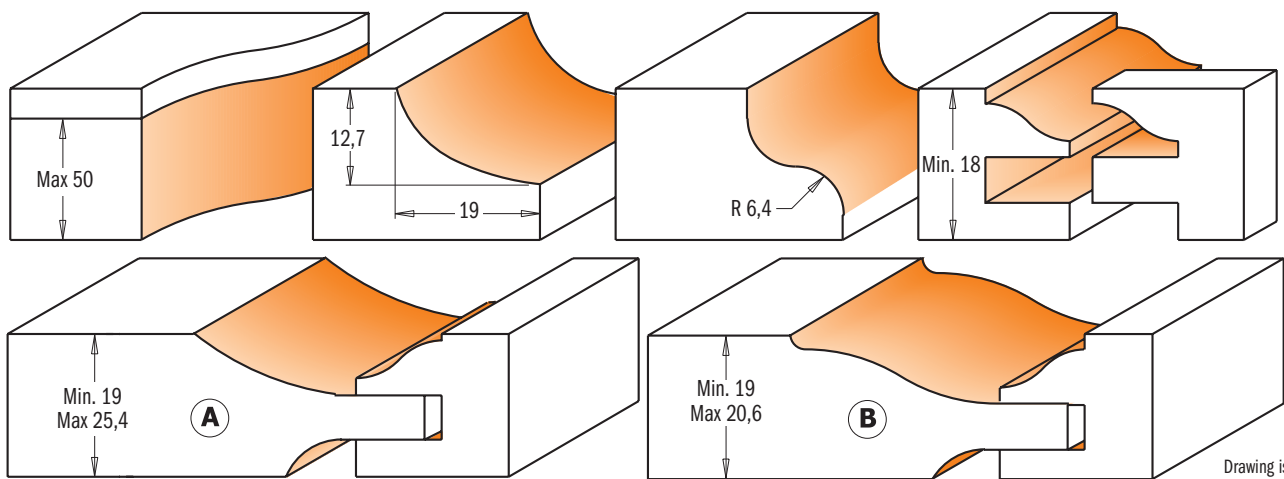

Small Arch Door Set



800.524 - 900.024



These 3 piece sets will produce beautifully raised panel doors with a classic bevelled profile. Designed for use in fine furniture making, these sets include two matched cope and stick bits to produce frames from 15,87mm to 19mm in thickness. The stick bit shapes a decorative 4,76mm thumbnail moulding along the edge of the frame.

The panel bit is designed for material 12,7mm in thickness. All bits are equipped with guide bearings for shaping curved work such as the small arched panel doors seen on secretaries and corner cabinetry.

These sets also produce panels for small chests, lids for small boxes, or drawer fronts.

Available in 8mm and 12,7mm shanks.

DESCRIPTION	Box	ORDER NO. S=Ø8mm	ORDER NO. S=Ø12,7mm
Small Arch Door Set (3 pcs. HW)	1	900.024.11	800.524.11

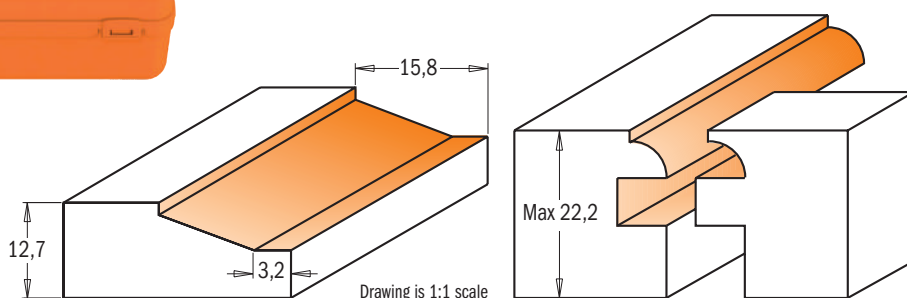



These CMT's sets aren't only a random selection of odds and ends packaged in a handy carry case, but they are also professional kits for drawer and door makers. 3 sets to choose from, 5 different bits to suit your needs: a raised panel bit, rail and stile bits, a glue joint and a drawer lock bit. Please refer to the illustrations below for complete profile options.



DESCRIPTION	1	ORDER NO. S=Ø12mm	ORDER NO. S=Ø12,7mm
CMT's Complete Kitchen Set - Profile A (5 pcs. HW)	1	900.509.11	800.509.11
CMT's Complete Kitchen Set - Profile B (5 pcs. HW)	1	900.510.11	800.510.11
CMT's Complete Kitchen Set - Profile C (5 pcs. HW)	1	900.511.11	800.511.11

8/900.509.11

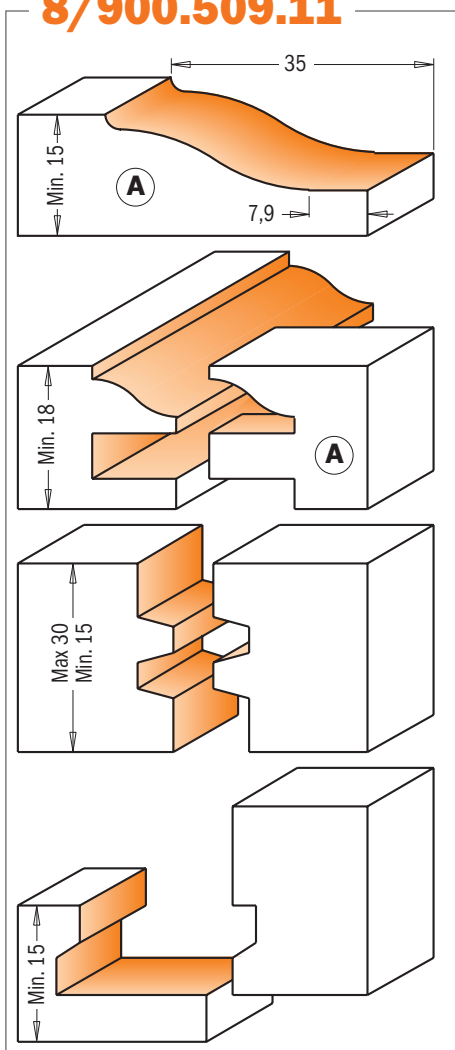

8/900.510.11

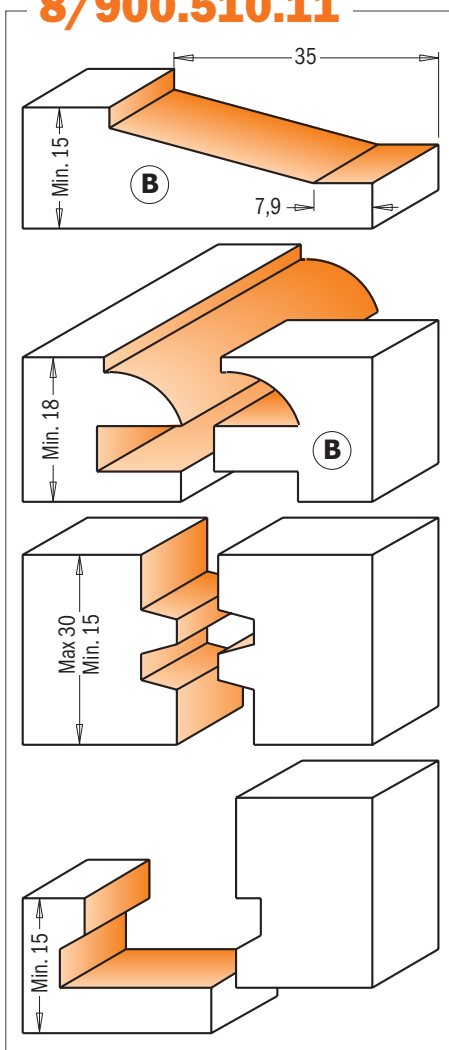

8/900.511.11

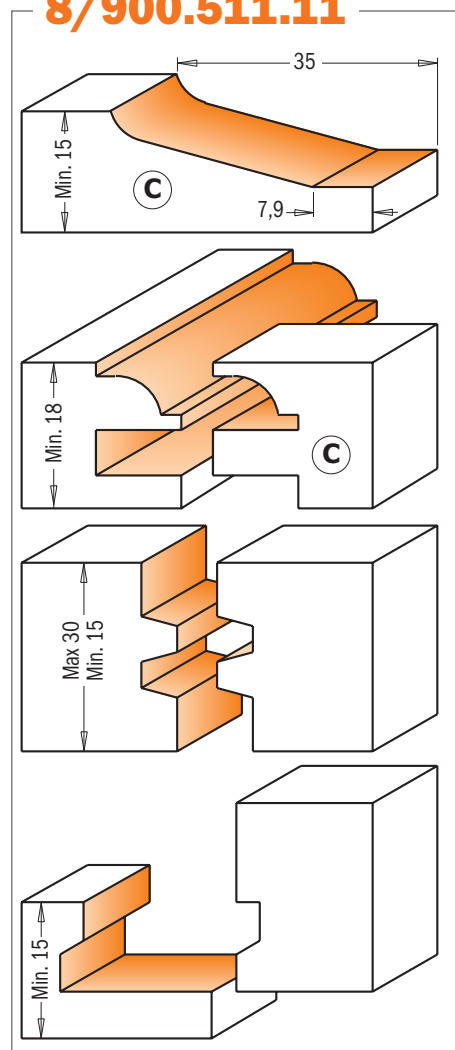

Drawing is 1:1 scale

Panalign Strips

Beautiful panel doors can be ruined by a poorly-aligned panel. Next time, slip panalign strips into the rails to keep panels perfectly centred while allowing for expansion. Unlike carpet foam, which eventually loses elasticity and ceases to work, the rubber in panalign strips is specially designed to spring back indefinitely. The rectangular shape makes the strips easy to handle. Typical doors require 4 to 8 strips each.

PNL-001

DESCRIPTION	DIMENSION mm	QTY.	1	ORDER NO.
Panalign Strips	27x7x7	200	1	PNL-001



Kitchen Set



Our 3 piece kitchen set includes a couple of rail and stile bits and a raised panel bit. Choose among 4 possible profiles to make panel doors easily economically. Supplied in a protective carry case: perfect for keeping your bits safe, organized and within reach.



DESCRIPTION		ORDER NO. S=Ø12mm	ORDER NO. S=Ø12,7mm
Kitchen Set - Profile A+A ₂	1	900.513.11	800.513.11
Kitchen Set - Profile B+B ₂	1	900.512.11	800.512.11
Kitchen Set - Profile C+C ₂	1	900.514.11	800.514.11
Kitchen Set - Profile D+B	1	900.516.11	800.516.11

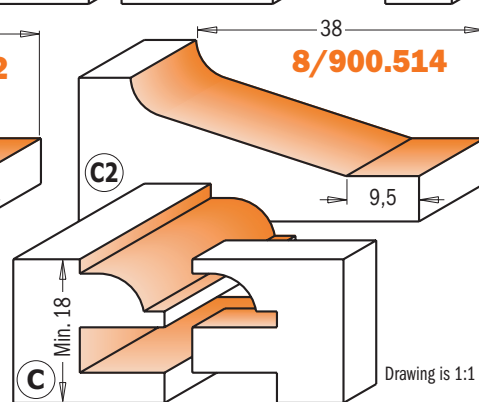
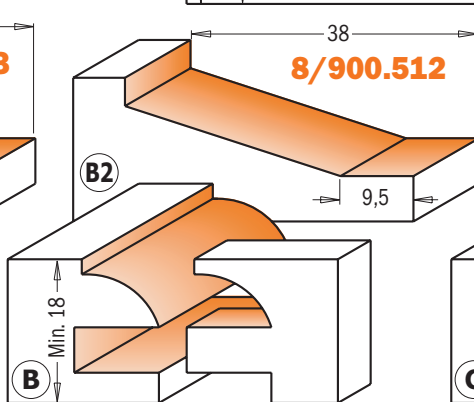
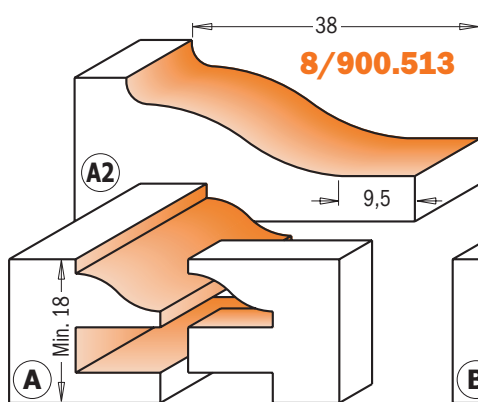
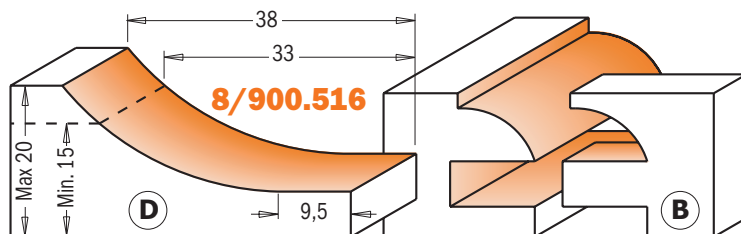

Drawing is 1:1 scale

The Raised Panel Set with Backcutter



8/900.518 - 8/900.522     

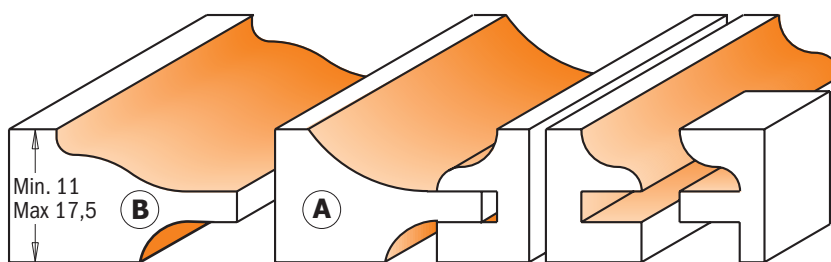

Drawing is 1:1 scale

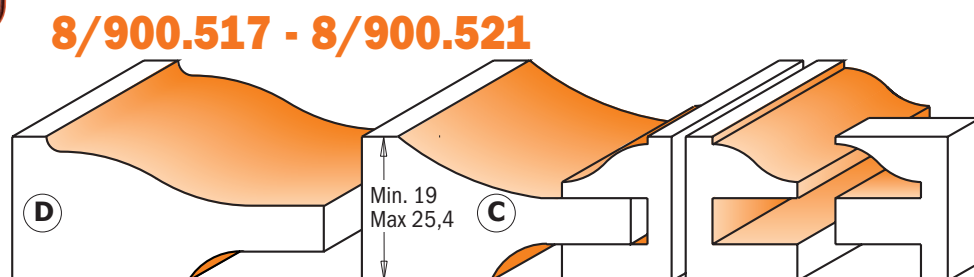

The set includes a choice of a cove or an ogee raised panel bit and an ogee rail & stile pair. All tools are supplied in a robust protective carry case.

DESCRIPTION		ORDER NO. S=Ø12mm	ORDER NO. S=Ø12,7mm
Junior Raised Panel Set - Profile A (3 pcs. HW) Ø63,5mm.	1	900.518.11	800.518.11
Junior Raised Panel Set - Profile B (3 pcs. HW) Ø63,5mm.	1	900.522.11	800.522.11
Raised Panel Set - Profile C (3 pcs. HW) Ø89mm.	1	900.517.11	800.517.11
Raised Panel Set - Profile D (3 pcs. HW) Ø89mm.	1	900.521.11	800.521.11

Adjustable Shaker Router Bit Set



8/900.624

These new bit sets are excellent for producing adjustable tongue and groove joints with a bevel, in order to eliminate panel rattle that may occur with the production of standard cabinets. Cut precise grooves into your plywood veneered panels and make perfect rattle-free fits. To be used on table-mounted routers. Avoid using these bits in hand-held power tools.

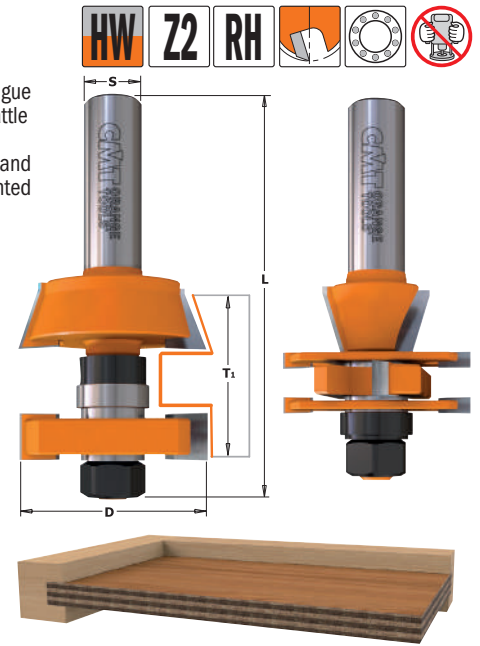
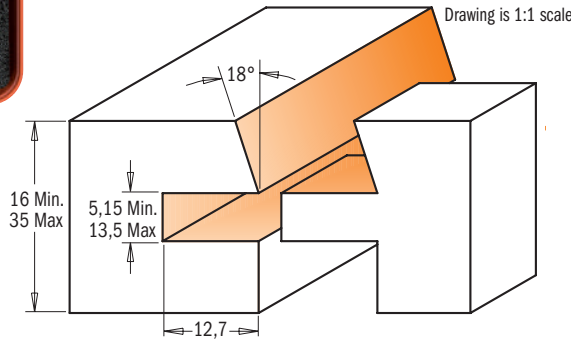

D mm	T ₁ mm	A	L mm		ORDER NO. S=Ø12mm	ORDER NO. S=Ø12,7mm
41,2	16-35	18°	87	5	900.624.11	800.624.11

Spare parts

791.025.00	822.025.11 3,7mm	822.026.11 7,14mm	822.027.11 3,7mm	822.028.11 10,4mm	990.020.00

Spare parts: 541.515.00 0,1mm spacer
541.516.00 0,3mm spacer
541.517.00 0,5mm spacer

541.518.00 1mm spacer
541.500.00 3mm spacer
541.519.00 5,8mm spacer

Adjustable Tongue & Groove Bit Set for Mission Style Cabinet Doors



8/900.625

Exclusive CMT design which allows the perfect fit for undersized plywood panel. The tongue cutter features opposing shear angles to obtain flawless finishing on a large variety of materials such as plywood, softwood and hardwood.

For use on a table-mounted router. Not for handheld routers.

- Adjustable in 0.050mm (0.002") increments;
- For groove width from 5mm to 13,5mm;
- Cut stock thickness of 12,7mm to 31,7mm;
- Features micrograin carbide for longer life.

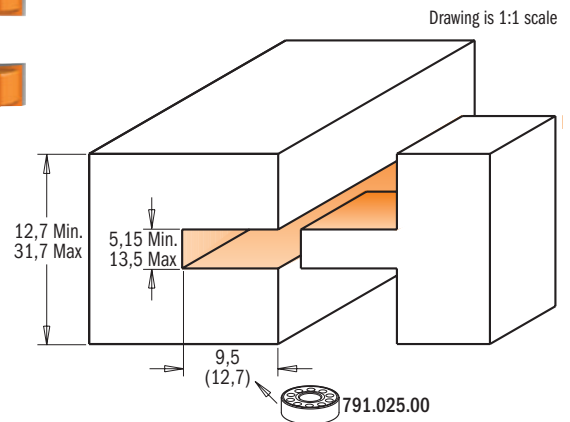
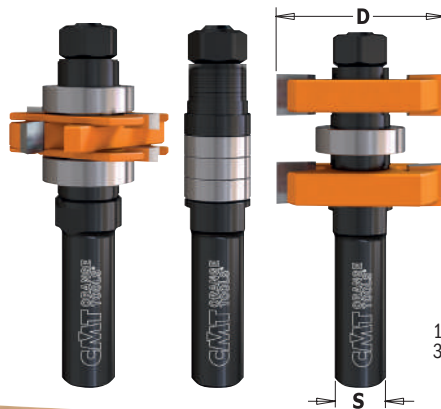

D mm	T ₁ mm		ORDER NO. S=Ø12mm	ORDER NO. S=Ø12,7mm
41,2	5,15-13,5	5	900.625.11	
41,2	12,7-31,7	5		800.625.11

Spare parts

924.136.00	791.012.00 8-22mm	822.025.11 3,7mm	822.026.11 7,14mm	822.027.11 3,7mm	822.028.11 10,4mm	990.020.00
824.136.00	791.012.00	822.025.11	822.026.11	822.027.11	822.028.11	990.020.00

Spare parts: 541.515.00 0,1mm spacer
541.516.00 0,3mm spacer
541.517.00 0,5mm spacer

541.518.00 1mm spacer
541.500.00 3mm spacer
541.519.00 5,8mm spacer

Slot Cutter Set



8/923.001

Create slots, grooves and rabbets on all materials using these slot cutter sets. Ideal for biscuit and tongue and groove joints. These sets include 4 different bearings to allow a cutting depth of 8mm, 9,5mm, 12,8mm and 14,3mm. Please refer to the chart below for applications and the correct cutter combinations.

SAFETY TIPS: never use the slot cutter sets without shims between cutters, whose distance can vary from 1mm to 1,7mm. Shims can also be positioned between the ball bearings and the cutters.



ASSEMBLY ILLUSTRATION

924.081.10 S=8mm
824.121.10 S=12,7mm
924.082.10 S=8mm
824.122.10 S=12,7mm
924.080.10 S=8mm
824.127.10 S=12,7mm
924.083.10 S=8mm
824.128.10 S=12,7mm

47,6

H

Spare parts		
H mm	Order No.	Order No.
14,3	8-19	791.034.00
12,7	8-22	791.005.00
9,5	8-28,5	791.030.00
8	8-31,5	791.033.00

DESCRIPTION	Box	ORDER NO. S=Ø8mm	Spare parts								
			2mm	3mm	4mm	5mm	6mm	924.081.10	924.082.10	924.080.10	924.083.10
Slot cutter set	1	923.001.11	822.320.11	823.330.11	823.340.11	823.350.11	822.360.11	924.081.10	924.082.10	924.080.10	924.083.10

DESCRIPTION	Box	ORDER NO. S=Ø12,7mm	Spare parts								
			1,6mm	3,2mm	4mm	4,8mm	6,4mm	824.121.10	824.122.10	824.127.10	824.128.10
Slot cutter set	1	823.001.11	822.316.11	823.332.11	823.340.11	822.348.11	822.364.11	824.121.10	824.122.10	824.127.10	824.128.10

5 Piece Straight Bit Set & Profile Bit Set

A three 5 piece set with a selection of straight bits and the most popular profile router bits. Sold in a robust protective carry case.



900.005.01

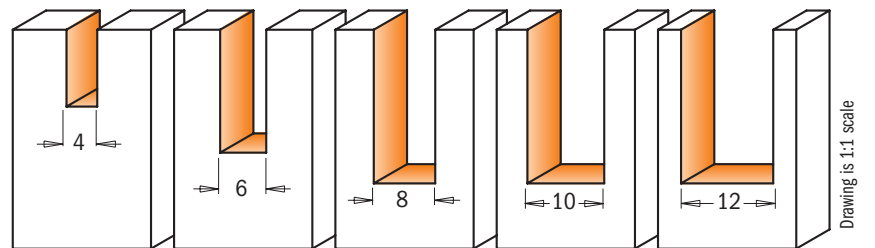

DESCRIPTION	Box	ORDER NO. S=Ø8mm
5 Piece Straight Bit Set	5	900.005.01

7/900.005.03

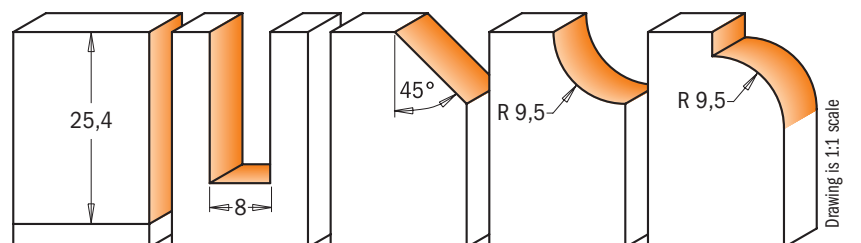

DESCRIPTION	Box	ORDER NO. S=Ø6mm	ORDER NO. S=Ø8mm
5 Piece Profile Bit Set	5	700.005.03	900.005.03

Router Bit Set with Insert Knives



600.005.01

This set is the perfect companion for the professional craftsman. We offer the 5 most popular bits with reversable knives complete with 10 spare knives and 2 TORX® keys. They are perfect for working on all materials such as solid wood, wood derivatives, laminates, MDF, and plastic materials. For use with a hand held, point-to-point machine or CNC router.

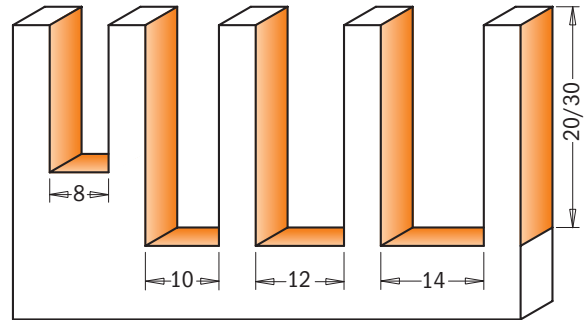

Drawing is 1:1 scale

SAFETY TIPS



The **TW-006** Torque Screwdriver is recommended for the proper fastening of screws (see page 413).

DESCRIPTION	Box	ORDER NO. S=Ø8mm
Router Bit Set with Insert Knives	1	600.005.01

10 spare knives and 2 TORX® keys included

SET CONTAINS	D mm	I mm	KNIVES	Box	ORDER NO. S=Ø8mm
Straight Router Bit with Knife	8	20	790.200.01 - 20 x 4,1 x 1,1mm		651.080.11
Straight Router Bit with Knife	10	30	790.300.01 - 30 x 5,5 x 1,1mm		651.100.11
Straight Router Bit with Knife	12	30	790.300.01 - 30 x 5,5 x 1,1mm		651.120.11
Straight Router Bit with Knife	14	30	790.300.01 - 30 x 5,5 x 1,1mm		651.140.11
Flush Trim Bit with Knife	19	30	790.300.00 - 30 x 12 x 1,5mm	791.007.00	657.191.11

5 Piece Spiral Bit Set



191.0/192.0



This new set of high quality solid tungsten carbide upcut and downcut spiral bits come in the most popular diameters: 4-8-10-12mm. These bits featuring sharp long-lasting cutting edges guarantee perfect high quality cuts, and the spiral layout allows for a more efficient chip ejection. Recommended for use on hardwood, wood derivatives, laminates and plastic materials.

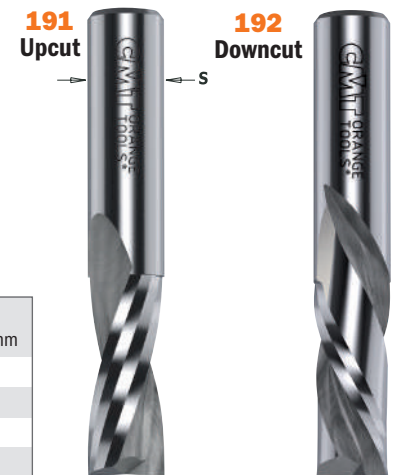
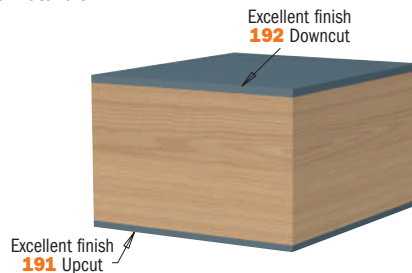

DESCRIPTION	Box	ORDER NO. S=Ø8mm	ORDER NO. S=Ø6,35-12,7mm
5 Piece Upcut Spiral Bit Set (Ø4 - 6 - 8 - 10 - 12mm)	5	191.000.01	
5 Piece Downcut Spiral Bit Set (Ø4 - 6 - 8 - 10 - 12mm)	5	192.000.01	
5 Piece Upcut Spiral Bit Set (Ø4,76 - 6,35 - 8 - 9,5 - 12,7mm)	5		191.000.02
5 Piece Downcut Spiral Bit Set (Ø4,76 - 6,35 - 8 - 9,5 - 12,7mm)	5		192.000.02

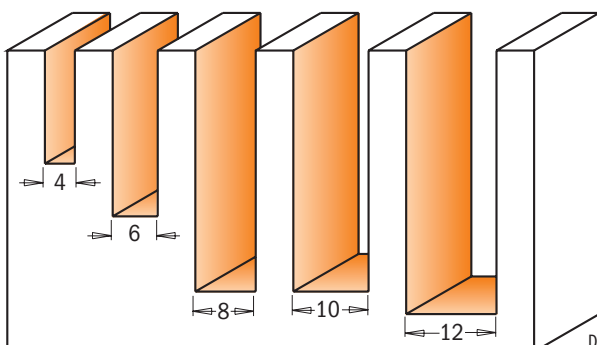

Drawing is 1:1 scale

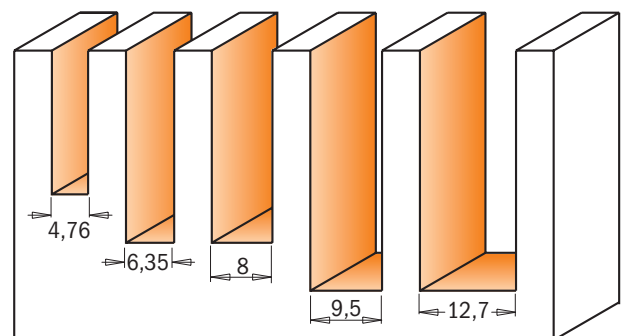

CONTRACTOR ROUTER BIT FROM CMT



DELUXE PACKAGING



For value-driven contractors, remodelers and DIYers. Great quality/price ratio and long-lasting performance.



HEAT-TREATED SHANK & BODY FOR GREATER DURABILITY

The bits are made from the finest steel hardened to reach 58 Rockwell which ensures durability and good cutting performance.



ANTI-KICKBACK DESIGN

Controls depth of cut and minimizes kickback reducing your risk of injury.



SINTERHIP HI-DENSITY CARBIDE

New process called SinterHIP (Hot Isostatic Pressing), helps prevent material failure and increases cutting life.



CORROSION-FREE BLACK COATING

Protects against corrosion and provides a longer bit life.

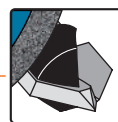

PRECISION GROUND CUTTING EDGES

Each cutting edge is precisely sharpened to obtain a sharp and durable cutting angle.

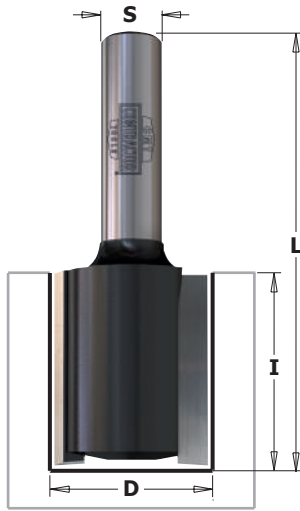

K911-K912



Designed for making slots and routing channels in wood and wood composites. Hi-Density carbide-tipped cutting edges provide smooth performance and a precise cut. Engineered for efficient chip clearance.

D mm	I mm	L mm	Z		ORDER NO. S=Ø8mm
3	8	51	1	10	K911-030
4	11	51	1	10	K911-040
5	12,7	51	1	10	K911-050
6	16	51	1	10	K911-060
6	25,4	57	2	10	K912-060
8	20	51	2	10	K911-080
8	32	62	2	10	K912-080
10	20	51	2	10	K911-100
10	32	62	2	10	K912-100
12	20	51	2	10	K911-120
12	32	62	2	10	K912-120
14	25,4	56	2	10	K911-140
15	25,4	56	2	10	K911-150
16	25,4	56	2	10	K911-160
18	25	56	2	10	K911-180
20	25	56	2	10	K911-200
22	25,4	56	2	10	K911-220
24	25,4	56	2	10	K911-240
25	25,4	57	2	10	K911-250

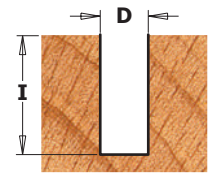

Drawing is 1:1 scale

Straight Bits with Centre Tip



K174



Thanks to the center tip the cutting edge allows you to execute any kind of plunge drilling and trimming jobs on soft or hardwood, wood composites and plastic or laminated materials.

D mm	I mm	L mm	Z		ORDER NO. S=Ø8mm
8	20	51	2+1	10	K174-080
8	40	90	2+1	10	K174-082
10	20	51	2+1	10	K174-100
10	40	90	2+1	10	K174-101
12	20	51	2+1	10	K174-120
12	40	90	2+1	10	K174-121
16	20	51	2+1	10	K174-160
16	40	90	2+1	10	K174-161
18	20	51	2+1	10	K174-180
20	20	51	2+1	10	K174-200
22	20	70	2+1	10	K174-220

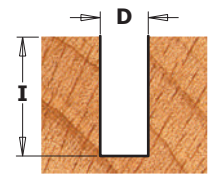

Drawing is 1:1 scale

PLUNGE CENTRE TIP

This particular kind of cutting edge guarantees long-lasting performance during plunging operations.



Pattern Bits



K911B

Our pattern bit makes template routing easy and accurate. Create cabinets, furniture, signs, toys or just about any other project you can imagine. Our smooth-running top bearing will glide along your template creating a perfect copy in the wood piece below.



D mm	I mm	L mm	Z		ORDER NO. S=Ø8mm
16	25,4	70	2	10	K911-160B
22	25,4	70	2	10	K911-220B

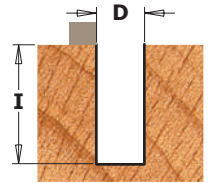

Drawing is 1:1 scale

Flush Trim Bits



K906

Precise flush trimming of wood or laminate material. Bottom bearing runs effortlessly against finished work piece delivering a smooth to the touch flush trim cut. Two carbide-tipped cutting edge design optimizes performance.



I mm	D mm	L mm	Z		ORDER NO. S=Ø8mm
14	9,5	56	2	10	K906-096
25,4	12,7	67	2	10	K906-127
25,4	19	67	2	10	K906-191

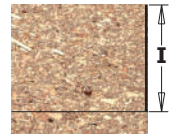

Drawing is 1:1 scale

Round Nose Bits

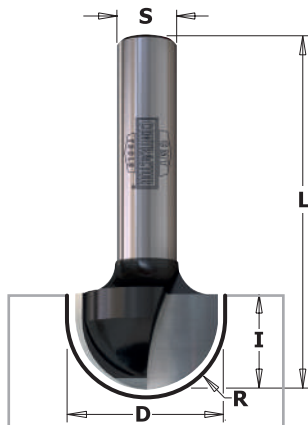

K914

Designed for sign and cabinet makers. Use the round nose to make decorative doors, drawer fronts, signs or add a design to any other creative project. Features two carbide-tipped cutting edges that provide a smooth cut in wood and wood derivatives.



R mm	D mm	I mm	L mm		ORDER NO. S=Ø8mm
3	6	9,5	40	10	K914-060
4,75	9,5	9,5	40	10	K914-095
6,35	12,7	12,7	40	10	K914-127
8	16	12,7	45	10	K914-160
9,5	19	12,7	46	10	K914-190

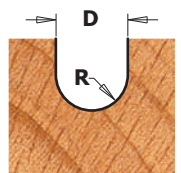

Drawing is 1:1 scale

V-Groove Bits

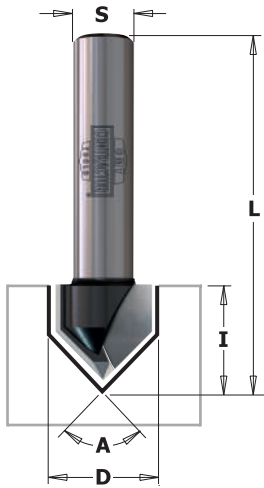

K915-K958

Make a clean sharp v-groove in panel and drawer fronts for decorative projects. Good for engraving letters for signs, they feature two sharp carbide-tipped cutting edges for smooth fast cutting. Choose from our 60° or 90° V-groove angle.



D mm	I mm	A	L mm	Z		ORDER NO. S=Ø8mm
12,7	12,7	90°	45	2	10	K915-127
16	16	90°	45	2	10	K915-160
31,8	20	90°	60	2	10	K915-317
11	14	60°	45	2	10	K958-110

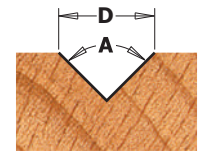

Drawing is 1:1 scale

Decorative Ogee Bit



K965

This new CMT bit produces a classic single or double-edged bead. Ideal for creating a marked decorative effect on panel, door and drawer work.



D mm	d mm	I mm	R mm	L mm		ORDER NO. S=Ø8mm
10	1,3	10	5	50,8	10	K965-100

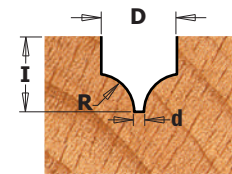

Drawing is 1:1 scale

Keyhole Bit



K950

Easily create a hardware-free way to hang pictures and plaques on a wall. Cuts a keyholed groove or slot in a variety of materials such as wood, plywood and laminates.



D mm	d mm	I mm	L mm		ORDER NO. S=Ø8mm
9,5	4,76	11,1	48	10	K950-095

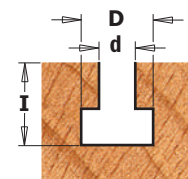

Drawing is 1:1 scale

Dovetail Bit

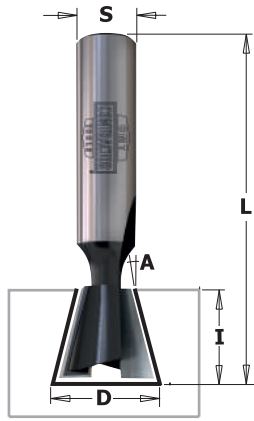

K918

Use our bits with some of the most popular dovetail jigs on the market to create clean dovetail joints in wood and wood composite material. Balanced for good performance.



D mm	I mm	L mm	A		ORDER NO. S=Ø8mm
12,7	12	45	14°	10	K918-127

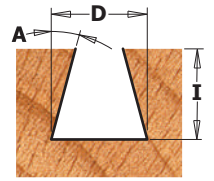

Drawing is 1:1 scale

Slot Cutters

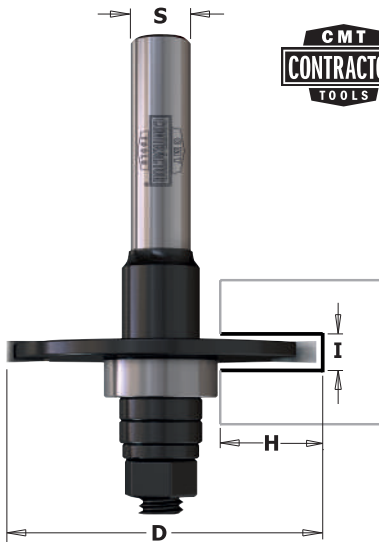

K922

Uses for these 2 wing slot cutter are almost infinite. Cut slots and grooves for splines, biscuits, T-molding or tongue and groove joints.



NOTE: For biscuit joints, use I=4mm slot cutter.

I mm	D mm	H mm	Z		ORDER NO. S=Ø8mm
3	40	12,5	2	10	K922-330A
4	40	12,5	2	10	K922-340A
5	40	12,5	2	10	K922-350A
6	40	12,5	2	10	K922-360A

Spare parts: 791.024.00 Ø6-15mm bearing
990.095.00 Hex nut M6 UNI-5588

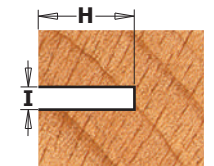

Drawing is 1:1 scale

Chamfer Bit

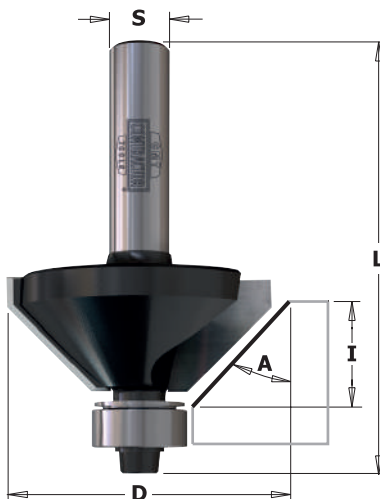

K936

Produce clean, accurate bevel or chamfer edges for edge jointing, decorative edges or perfectly aligned boxes. Features two carbide-tipped cutting edges, anti-kickback design with heat treated shank and body for durability. Bottom bearing included.



D mm	I mm	A	L mm		ORDER NO. S=Ø8mm
35	15	45°	56	10	K936-350



Drawing is 1:1 scale

Rabbeting Bit

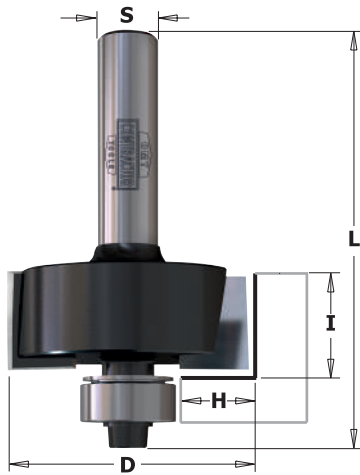

K935



Ideal for creating inset doors and drawer fronts or to re-groove old window frames to accept a panel of glass. Features two carbide-tipped cutting edges, anti-kickback design with heat treated shank and body for durability. Bottom bearing included.

D mm	I mm	H mm	L mm		ORDER NO. S=Ø8mm
31,8	12,7	9,5	54	10	K935-317

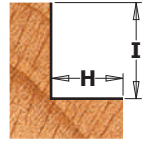

Drawing is 1:1 scale

Cove Bits

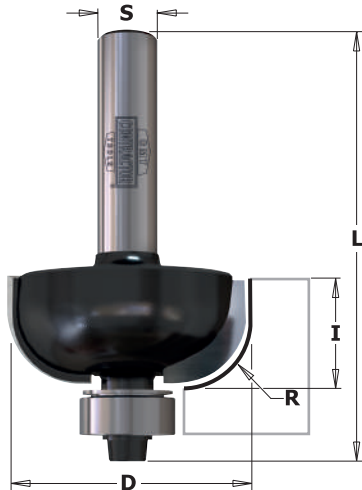

K937



Give your doors and drawer fronts an elegant touch. Pair a cove bit with a roundover bit to create decorative elements on your furniture projects. Features two carbide-tipped cutting edges, anti-kickback design, heat treated shank and body for durability. Bottom bearing included.

D mm	I mm	R mm	L mm		ORDER NO. S=Ø8mm
31,8	14	9,5	56	10	K937-317
38,1	16	12,7	62	10	K937-380



Drawing is 1:1 scale

Ovolo Bit



K927



Ideal for furniture makers, you get a roundover with top and bottom bead all in one. Bit equipped with two carbide-tipped cutting edges, features anti-kickback design and heat treated shank and body for increased durability.

D mm	I mm	R mm	L mm		ORDER NO. S=Ø8mm
25,4	14,3	6,3	46	10	K927-064

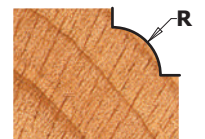

Drawing is 1:1 scale

Roundover & Beading Bits

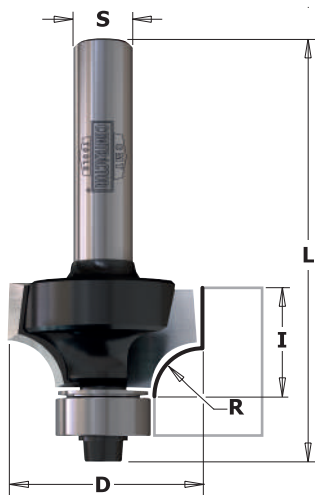

K938

A popular profile for taking the edge off a sharp corners. When partnered with a cove bit, you can create a drop-leaf table or other intricate projects. Bits equipped with two carbide-tipped cutting edges, anti-kickback design, and heat treated shank/body for increased durability. Bottom bearing included.



D mm	I mm	R mm	L mm		ORDER NO. S=Ø8mm
16,7	7,9	2	51	10	K938-167
18,7	10,5	3	53	10	K938-187
22,2	12,7	4,8	54	10	K938-222
25,4	13,5	6,3	55	10	K938-254
28,7	15,5	8	53	10	K938-287
31,8	16,5	9,5	58	10	K938-317
38,1	19	12,7	61	10	K938-380
44,7	22,2	16	67	10	K938-445



EACH BIT INCLUDES A 9mm (3/8") BEARING FOR BEADING PROFILES

Drawing is 1:1 scale

Roman Ogee Bit

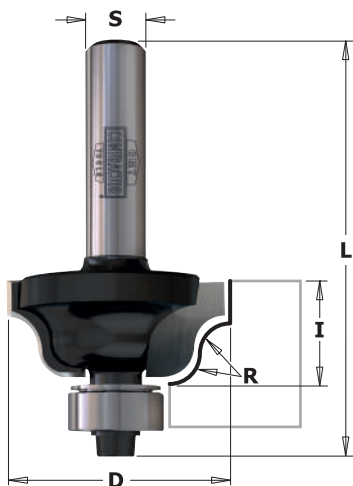

K940

A very popular bit for making a wavy profile which, gives a touch of class to your furniture. These bits feature an anti-kickback design, rust-resistant black coating and include a smooth running bearing for template work.



D mm	I mm	R mm	L mm		ORDER NO. S=Ø8mm
28,6	12,7	4	54	10	K940-286



Drawing is 1:1 scale

Classical Ogee Bits

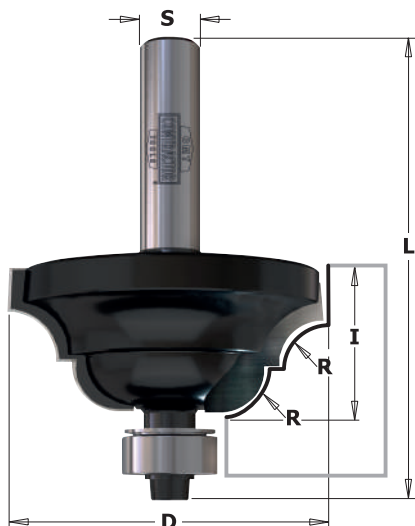

K941

This bit produces both a concave and a convex profile on your work piece for smooth eye-catching detail! They feature 2 sharp cutting edges, rust-resistant black coating and are equipped with a bottom bearing for easy template work on both natural wood and wood-based materials.



D mm	I mm	R mm	L mm		ORDER NO. S=Ø8mm
42,9	18	6,3	60	10	K941-430



Drawing is 1:1 scale

Finger Pull Bit

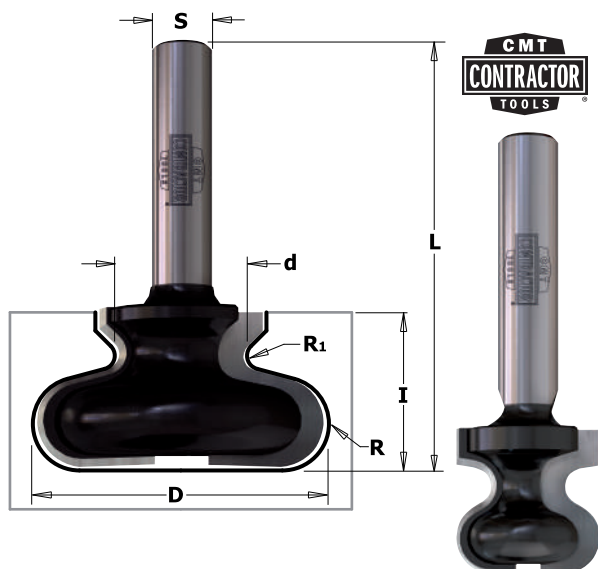

K955



Why interrupt the subtle linearity of an all-wood drawer front or cabinet door with a metal knob or handle? Use these finger pull bits and make a harmonious wooden handle. Two options are available: a template profile made directly in the wood or a European-style hardwood pull as illustrated below.

D mm	d mm	I mm	R mm	R ₁ mm	L mm		ORDER NO. S=Ø8mm
19,05	9,5	19,05	4,8	2,4	57,2	10	K955-190
38,1	17	20,7	6	1,8	55,4	10	K955-380

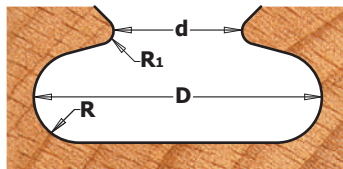

Drawing is 1:1 scale

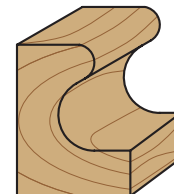

5 Piece Straight Router Bit Set



K900-005-01



D mm	I mm	L mm	Z	ORDER NO. S=Ø8mm
4	11	51	1	K911-040
6	16	51	1	K911-060
8	20	51	2	K911-080
10	20	51	2	K911-100
20	25	56	2	K911-200

5 Piece Basic Router Bit Set



K900-005-02



D mm	I mm	R mm	L mm	A	ORDER NO. S=Ø8mm
12	20		51		K911-120
16	25,4		70		K911-160B
12,7	25,4		67		K906-127
25,4	13,5	6,3	55		K938-254
35	15		56	45°	K936-350

Replacement Bearing Set

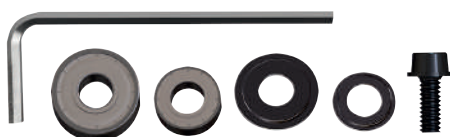

79101

Pack Qty. 10

SET INCLUDES	PIECES
3/8" Bearing	1
1/2" Bearing	1
3/8" Dust Shields	1
1/2" Dust Shields	1
Screw	1
Hex Key	1

What work parameters are best when routing?

Answering the following questions will provide you with the answer!

- **What equipment are you using?** Using brand new equipment of high quality is not the same as using outdated machinery! It is important to understand that vibration is the direct result of wear and tear, which can lead to a poor quality finish. Feed rate should be chosen in order to dampen vibration, and quite often, higher feed rates are associated with better finishing results.
- **What factors influence the performance of the bit I am using?** Many factors affect performance and the ultimate finish of the workpiece: the power of the collet chuck, the rigidity and eccentricity of the couplings, conditions and quality of the collets, reverse locking system, sharpened tool edge, the dust-collection system in use and even the relative humidity of the workplace environment.
- **What bit should I use?** The number of cutting edges as well as the cutting diameter significantly affect work parameters. In general, the more cutting edges and the wider the blade diameter, the higher the feed rate.
- **What is the cutting depth I hope to carry out?** In order to increase cutting depth, it is necessary to reduce the feed rate and vice versa for shallower cuts.
- **At what speed does my machine run?** By increasing the spindle speed (rpm), the quality of the finished edge improves. However, at the same time friction also increases between the tool and the workpiece. As a result, tool longevity is compromised. Ideally, the objective is to select the slowest rotation speed possible compatible with the quality of finishing you hope to achieve.
- **What edge finish am I looking to achieve?** Coarse routing and fine routing are definitely not the same thing! You need to figure out what is more important: quality or quantity. In order to prolong the life of your cutting tool, its best to choose the highest feed rate possible best suited to achieve the finish you want.
- **Above all....what materials am I working with?** Wood is a good example of natural fiber composite. It is made up of a natural fibrous material, both elastic and flexible (cellulose: long molecular polymer chains), bound together by a very rigid substance (lignin: cross-linked polymer) as well as a compatibilizer (hemicellulose: a polysaccharide). It is an anisotropic material, that is, directionally dependent, changing with direction along the object. How many types of wood and wood derivatives are you familiar with? Remember, no two pieces of wood are the same! In fact, the same work parameters carried out on two different pieces of wood will provide two very different results.

Feed rate is dependent of several factors, like the ones mentioned above - and these are just a few examples. It is important to weigh all factors in order to select an optimum feed rate suitable for the tools and work objectives involved. CMT is synonymous with quality and to produce high quality cuts you just can't randomly shoot off a bunch of numbers. Be wary of those who provide you with random numbers.

I get it....but where do I start? *The best way to go forward is step-by-step using reliable test data.* To quickly achieve the results best suited for your specific work expectations, you can always turn to theory!

One rule of thumb, which may prove advantageous, is to use a simple gauge to measure chipload wherever possible. On the one hand, it should be noted that when chips that are too thick, breakage will occur, resulting in a poor, rough finish. On the other hand, when chips are too thin, it will negatively affect tool longevity and cause rapid wear and tear of the cutting edge because the teeth of the tool are rubbing more than removing material.

The next time you experiment, you need to properly assess the specific demands of the work involved, assess chipload measurements and try to orient yourself towards a different thickness by taking into account the aforementioned factors. Then, with the aid of the formulas listed below, proceed to establish the appropriate feed rate for your next test. This will help you to achieve better results faster and you will have the essential information you will need for the next work project.

PARAMETERS:

V = Feed rate (m/min)

Z = Cutting edges

C = Chipload (mm)

FORMULAS:

V = (RPM x Z x C) / 1000

RPM = V x 1000 / (Z x C)

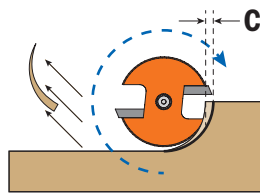

EXAMPLE:

with caliper take measurement of a good result chipload (C=0,2mm).

Z=2

RPM=18000

V = (RPM x Z x C) / 1000 = (18000x2x0,2) / 1000 = 7,2m/min

PROBLEM SOLVING

PROBLEM

Bad finishing
Cutting edge wear
Cutting edge burns
Cutting edge debris
Vibrations
Cutter breakage

SOLUTIONS

<ul style="list-style-type: none"> • Cutting depth • Vibrations
<ul style="list-style-type: none"> • Rotation speed • Vibrations
<ul style="list-style-type: none"> • Rotation speed • Number of cutting-edges
<ul style="list-style-type: none"> • Cutting depth
<ul style="list-style-type: none"> • Rotation speed • Cutting depth
<ul style="list-style-type: none"> • Feed speed • Cutting depth • Vibrations

INCREASE

<ul style="list-style-type: none"> • Rotation speed • Dust extraction • Number of cutting edges • Clamping cutter/chuck
<ul style="list-style-type: none"> • Feed speed
<ul style="list-style-type: none"> • Feed speed
<ul style="list-style-type: none"> • Rotation speed • Feed speed • Dust extraction
<ul style="list-style-type: none"> • Machine firmness • Workpiece firmness
<ul style="list-style-type: none"> • Shank diameter • Collet clamping • Change tool material (solid carbide or DENSIMET®)

DECREASE

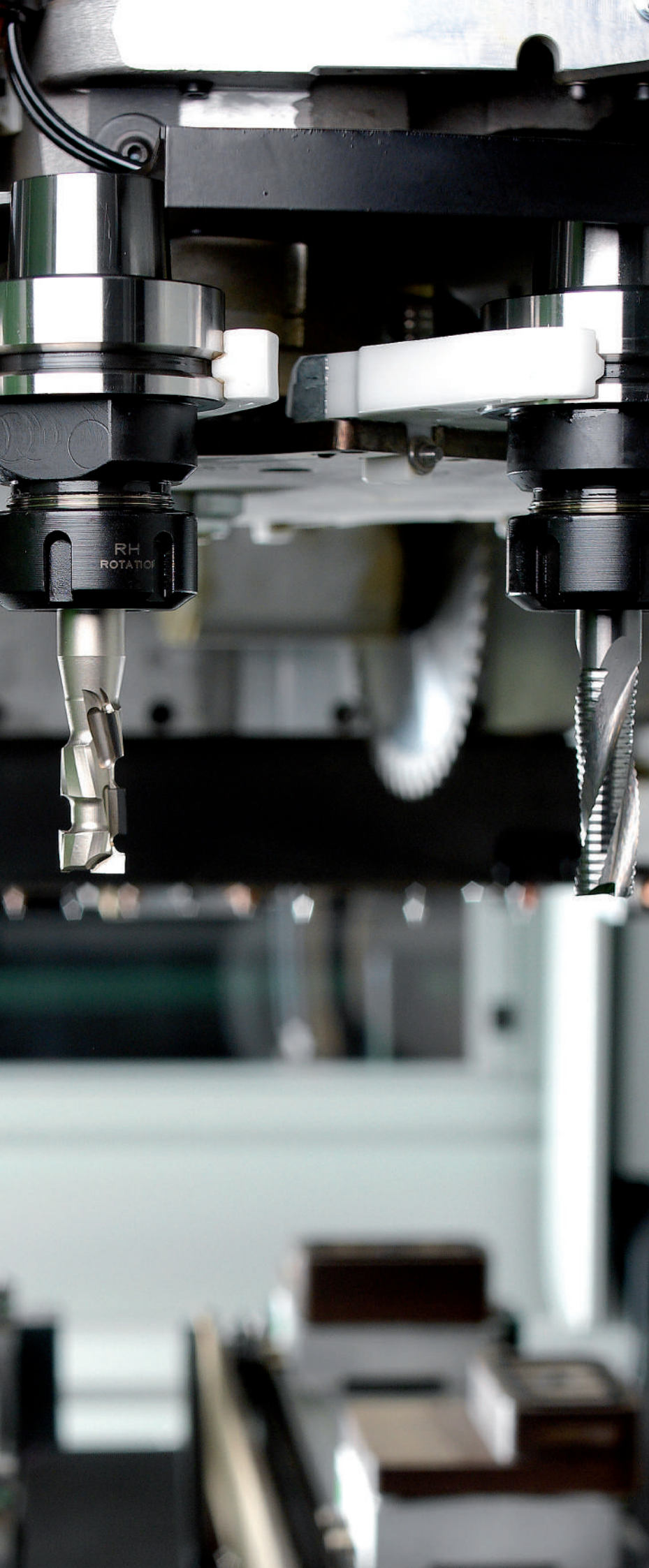

CNC ROUTER CUTTERS & CHUCKS

PRODUCTS	PAGE
Kinetic Dust Extractor	282
CNC Chucks	283~285
Precision Collets	286-287
Clamping Nuts	287
ISO30 Retaining Studs & C-Spanner	288
HSK Chucks for Grooving Blade	288-289
Cutter Arbor	290
Universal Assembly Supports for Chucks	290
DLCS Coating Solid Carbide Spiral Bits	291-292, 295, 299
Solid Carbide Spiral Bits	292~300, 302
Spiral Bits for Locksets	301
HSS Upcut Spiral Bits	301
Solid Surface & Fiberglass Bits with DLCS	303
DP - Straight Cutters for CNC	304~308
Straight Carbide Cutters for CNC	308~311
Cutters with Insert Knives for CNC	312~319
Slot & Mortise Bits	320~326



Kinetic Dust Extractor



992 REMOVES MDF & CHIPBOARD DUST FROM THE WORKPIECE

DESCRIPTION	D mm		ORDER NO.
Kinetic Dust Extractor for chucks with ER20	80	1	992.081.ER20
Kinetic Dust Extractor for chucks with ER25	80	1	992.081.ER25
Kinetic Dust Extractor for chucks with DIN6388/EOC25 collets	100	1	992.101.EOC25
Kinetic Dust Extractor for chucks with ER32 collets	100	1	992.101.ER32
Kinetic Dust Extractor for chucks with ER40 collets	100	1	992.101.ER40

Spare parts: **991.285.00** C-Spanner 80-90mm (ER20/ER25)
991.284.00 C-Spanner 95-100mm (EOC25/ER32/ER40)



EASY TO USE!

Installation and removal just like a clamping nut

- Better health & safety on the worksite
- Better air quality on the worksite
- Improves tool performance & cut quality
- Longer tool life & reduced labor costs
- Recommended for Nesting and routing operations
- No wasted time throughout operation
- Replaces the standard clamping nut
- Suitable for any collet chucks with standard router bits
- Available for ER32 - ER40 - EOC25 (DIN6388) collets
- Tough ceramic coating offers anti-corrosion, anti-friction and anti-static protection.
- Tool body in light alloy
- Lightweight and quiet
- Performs even at low RPM: from 6,000 up to 20,000 rpm
- Materials: chipboard, coated chipboard, MDF, CORIAN®, plasterboard, OSB, HPL.

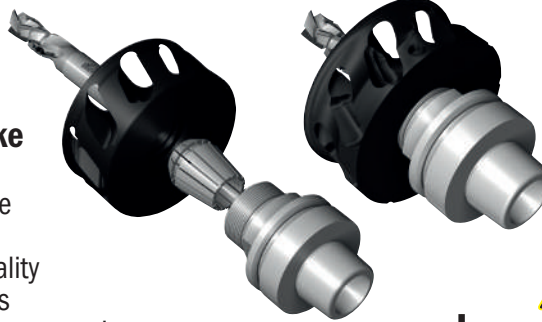

SAFETY TIPS

The **TW-200** Torque Wrench is recommended for the proper fastening of clamping nuts (see page 413).

Always use vacuum system.

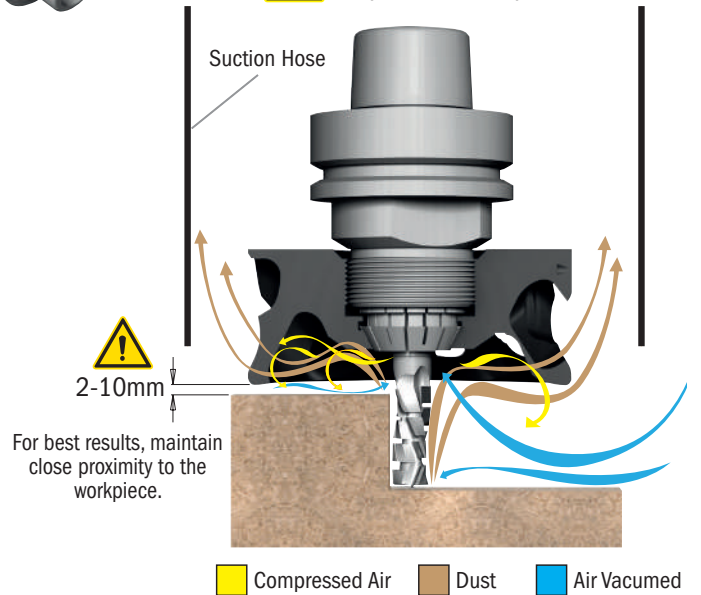

Download Instruction



Watch the video on **YouTube**

Working **WITHOUT** Kinetic Dust Extractor



Working **WITH** Kinetic Dust Extractor



HSK-63F Chucks for "ER32" Precision Collets

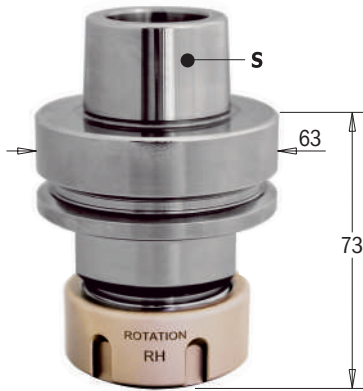

183.300 XTREME



S	TO BE USED WITH COLLET	ORANGE CHROME	NOTE	Box	ORDER NO. Right-hand rotation	ORDER NO. Left-hand rotation
HSK-63F	ER32	✓	Clamping nut without bearing	1	183.300.01	183.300.02
HSK-63F	ER32	✓	Clamping nut with bearing	1	183.300.11*	
HSK-63F	ER32		Clamping nut without bearing	1	183.300.91	
HSK-63F	ER32		Clamping nut with bearing	1	183.300.93*	

Optional: 990.118.00 M6x10mm screw

* Suitable for right-hand and left-hand rotation.

For HOMAG®, EIMA®, IMA® FROM 9/94, WEEKE®, BIESSE®, SCM®, MORBIDELLI® and MASTERWOOD® machines.



NON-STICK ORANGE CHROME® SHIELD COATING

- Prevents overheating.
- Protects against corrosion and rust.
- Reduces resin build-up.
- Longer life and greater tool performance.

SAFETY TIPS



The **TW-200** Torque Wrench is recommended for the proper fastening of clamping nuts (see page 413).

HSK-63F Chucks for "ER40" Precision Collets

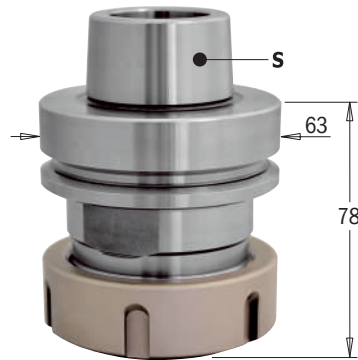

183.310 XTREME



S	TO BE USED WITH COLLET	ORANGE CHROME	NOTE	Box	ORDER NO. Right-hand rotation	ORDER NO. Left-hand rotation
HSK-63F	ER40	✓	Clamping nut without bearing	1	183.310.01	183.310.02
HSK-63F	ER40	✓	Clamping nut with bearing	1	183.310.11*	
HSK-63F	ER40		Clamping nut without bearing	1	183.310.91	
HSK-63F	ER40		Clamping nut with bearing	1	183.310.93*	

Optional: 990.117.00 M6x6mm screw

* Suitable for right-hand and left-hand rotation.

For HOMAG®, EIMA®, IMA® FROM 9/94, WEEKE®, BIESSE®, SCM®, MORBIDELLI® and MASTERWOOD® machines.



NON-STICK ORANGE CHROME® SHIELD COATING

- Prevents overheating.
- Protects against corrosion and rust.
- Reduces resin build-up.
- Longer life and greater tool performance.

SAFETY TIPS



The **TW-200** Torque Wrench is recommended for the proper fastening of clamping nuts (see page 413).

HSK-63F Chucks for "EOC25" Precision Collet "DIN6388"

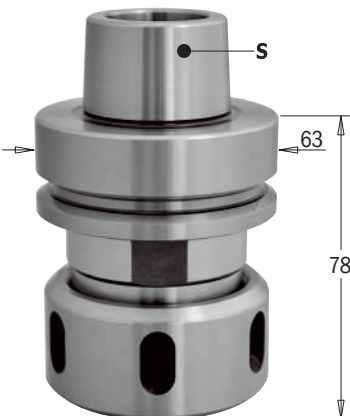

183.320



S	TO BE USED WITH COLLET	NOTE	Box	ORDER NO. Right-hand rotation	ORDER NO. Left-hand rotation
HSK-63F	EOC25	Clamping nut with bearing	1	183.320.01*	
HSK-63F	EOC25	Clamping nut without bearing	1	183.320.03	

Spare parts: 992.283.01 Clamping nut without bearing
992.283.11 Clamping nut with bearing

* Suitable for left-hand rotation too.

For HOMAG®, EIMA®, IMA® FROM 9/94, WEEKE®, BIESSE®, SCM®, MORBIDELLI® and MASTERWOOD® machines.



NON-STICK ORANGE CHROME® SHIELD COATING

- Prevents overheating.
- Protects against corrosion and rust.
- Reduces resin build-up.
- Longer life and greater tool performance.

SAFETY TIPS



The **TW-200** Torque Wrench is recommended for the proper fastening of clamping nuts (see page 413).

HSK-63F Chucks for Shrink Fit Holders

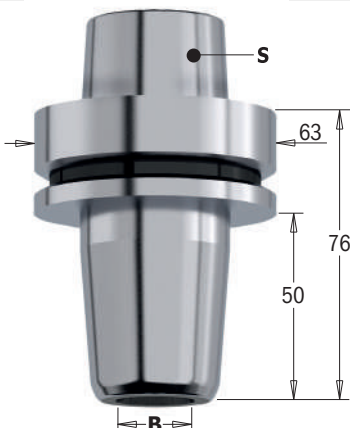

183.075



S	B mm	Box	ORDER NO.
HSK-63F	12	1	183.075.12
HSK-63F	16	1	183.075.16
HSK-63F	20	1	183.075.20
HSK-63F	25	1	183.075.25

SPECIAL STEEL UNI 1.2344

- Prevents overheating.
- Protects against corrosion and rust.
- Longer life and greater tool performance.

ISO30 Chucks for "ER32" Precision Collets

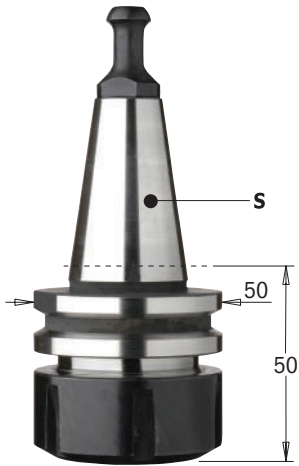

995.200 For BIESSE® machines.

183.200

RH LH

S	TO BE USED WITH COLLET	RETAINING STUD mm		ORDER NO. Right-hand rotation	ORDER NO. Left-hand rotation
ISO30	ER32	Ø12-8	 1	183.200.01	183.200.02



995.201 For BIESSE® machines with OMLAT® engine, NUOVA BULLERI BREVETTI®, BUSELLATO®, CMS® and IMA® machines.

183.210

RH LH

S	TO BE USED WITH COLLET	RETAINING STUD mm		ORDER NO. Right-hand rotation	ORDER NO. Left-hand rotation
ISO30	ER32	Ø13-9	 1	183.210.01	183.210.02



995.202 For ALBERTI® and MASTERWOOD® machines.

183.220

RH LH

S	TO BE USED WITH COLLET	RETAINING STUD mm		ORDER NO. Right-hand rotation	ORDER NO. Left-hand rotation
ISO30	ER32	Ø12,8-9	 1	183.220.01	183.220.02

SAFETY TIPS



The **TW-200** Torque Wrench is recommended for the proper fastening of clamping nuts (see page 413).

ISO30 Chucks for "ER40" Precision Collets

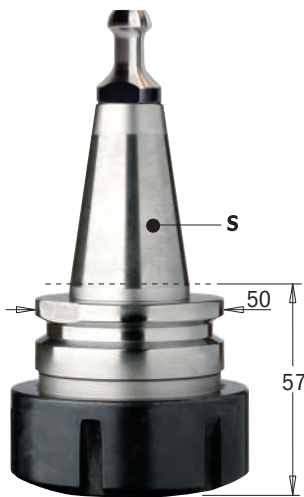

995.200 For BIESSE® machines.

183.201

RH

S	TO BE USED WITH COLLET	RETAINING STUD mm		ORDER NO. Right-hand rotation	
ISO30	ER40	Ø12-8	 1	183.201.01	



995.201 For BIESSE® machines with OMLAT® engine, NUOVA BULLERI BREVETTI®, BUSELLATO®, CMS® and IMA® machines.

183.211

RH

S	TO BE USED WITH COLLET	RETAINING STUD mm		ORDER NO. Right-hand rotation	
ISO30	ER40	Ø13-9	 1	183.211.01	



995.202 For ALBERTI® and MASTERWOOD® machines.

183.221

RH

S	TO BE USED WITH COLLET	RETAINING STUD mm		ORDER NO. Right-hand rotation	
ISO30	ER40	Ø12,8-9	 1	183.221.01	

SAFETY TIPS



The **TW-200** Torque Wrench is recommended for the proper fastening of clamping nuts (see page 413).

ISO30 Chucks for "ER32" Precision Collets

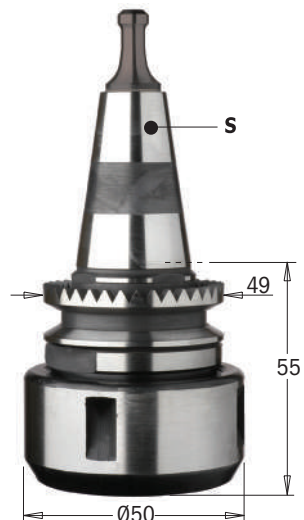

995.250 For MORBIDELLI® and SCM® machines.

183.250

RH LH

S	TO BE USED WITH COLLET	RETAINING STUD mm		ORDER NO. Right-hand rotation	ORDER NO. Left-hand rotation
ISO30	ER32	Ø8,5	 1	183.250.01	183.250.02

SAFETY TIPS



The **TW-200** Torque Wrench is recommended for the proper fastening of clamping nuts (see page 413).

Chucks for "ER32" Precision Collets

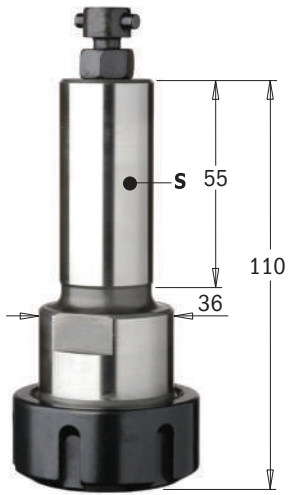

183.400

RH

S mm	TO BE USED WITH COLLET	RETAINING STUD		ORDER NO. Right-hand rotation	
Ø25x55	ER32	LEUCO® P-SYSTEM®	1	183.400.01	

For machines with LEUCO® P-SYSTEM®.

SAFETY TIPS



The **TW-200** Torque Wrench is recommended for the proper fastening of clamping nuts (see page 413).

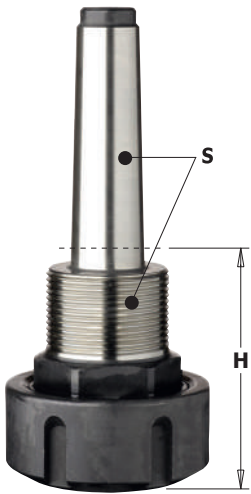

183.000/100 WITH MK2/MK3 TAPERED SHANK

RH LH

S mm	TO BE USED WITH COLLET	H mm		ORDER NO. Right-hand rotation	ORDER NO. Left-hand rotation
MK2/M30x1,5	ER32	62	1	183.000.01	183.000.02
MK3/M30x1,5	ER32	70	1	183.100.01	

MK2/MK3 tapered shank

SAFETY TIPS



The **TW-200** Torque Wrench is recommended for the proper fastening of clamping nuts (see page 413).

Chucks for Biconical Collets with MK2 Tapered Shank

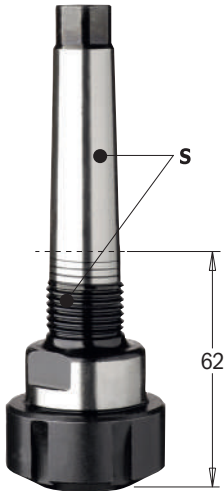

123

RH LH

S		ORDER NO. Right-hand rotation	ORDER NO. Left-hand rotation
MK2/Ø20x14Fx1"	1	123.000.01	123.000.02

Spare parts: **992.123.01** Clamping nut RH
992.123.02 Clamping nut LH
991.123.00 C-spanner

SAFETY TIPS



The **TW-200** Torque Wrench is recommended for the proper fastening of clamping nuts (see page 413).

The **TW-2836** Hook Insert can be used with this item (see page 413).

124 BICONICAL COLLETS

	B mm		ORDER NO.	B mm		ORDER NO.
	6	1	124.060.00	10	1	124.100.00
	6,35	1	124.064.00	12,7	1	124.120.00
	8	1	124.080.00	12,7	1	124.127.00
	9,5	1	124.095.00	14	1	124.140.00

Cap Nuts for CNC Machines



993.0

RH LH

INTERNAL THREAD		ORDER NO. Right-hand rotation	ORDER NO. Left-hand rotation
Ø20x14Fx1"	1	993.020.01	993.020.02
M30x1,5	1		993.030.02

For machines with M33x3 threaded spindle nose.

■ Until stock last

Precision Collets "DIN6499"

184 TECHNICAL DETAILS:

Replaceable **Standard Precision 0.015** collets. 0; -0,7mm wide clamping tolerance.
 Replaceable **High Precision 0.005** collets. 0; -1mm wide clamping tolerance.
 Suitable for most conical chucks. Fit most tapered spindle noses.

Special dimensions available on request.



RUN-OUT
 This tolerance is guaranteed only on the nominal diameter



ER11

B mm	ORDER NO. STANDARD
2	184.020.11
3	184.030.11
4	184.040.11
5	184.050.11
6	184.060.11

BULK PACK 10 PCS.



ER16

B mm	B inches	ORDER NO. STANDARD	B mm	B inches	ORDER NO. STANDARD
2		184.020.16	7		184.070.16
3		184.030.16	8 5/16		184.080.16
4		184.040.16	9		184.090.16
5		184.050.16	10		184.100.16
6		184.060.16			

BULK PACK 10 PCS.



ER20

B mm	B inches	ORDER NO. STANDARD	B mm	B inches	ORDER NO. STANDARD
2		184.020.20	8 5/16		184.080.20
3		184.030.20	9		184.090.20
4		184.040.20	10		184.100.20
5		184.050.20	11		184.110.20
6		184.060.20	12		184.120.20
6,35	1/4	184.064.20	12,7	1/2	184.127.20
7		184.070.20			

BULK PACK 10 PCS.



ER25

B mm	B inches	ORDER NO. STANDARD
3		184.030.25
4		184.040.25
5		184.050.25
6		184.060.25
6,35	1/4	184.064.25
8	5/16	184.080.25
9		184.090.25
10		184.100.25
12		184.120.25
12,7	1/2	184.127.25
14		184.140.25
16	5/8	184.160.25

BULK PACK 10 PCS.



For chucks:

183.000/100/200/250/300/400

ER32



B mm	B inches	ORDER NO. STANDARD	ORDER NO. HIGH	B mm	B inches	ORDER NO. STANDARD	ORDER NO. HIGH
3		184.030.00		11		184.110.00	
4		184.040.00	184.040.00H	12		184.120.00	184.120.00H
5		184.050.00		12,7	1/2	184.127.00	
6		184.060.00	184.060.00H	14		184.140.00	
6,35	1/4	184.065.00		15		184.150.00	
7		184.070.00		16	5/8	184.160.00	184.160.00H
8	5/16	184.080.00	184.080.00H	17		184.170.00	
9		184.090.00		18		184.180.00	
9,52	3/8	184.095.00		19	3/4	184.190.00	
10		184.100.00	184.100.00H	20		184.200.00	184.200.00H

BULK PACK 10 PCS.



For chucks:

183.201/211/221/310

ER40



B mm	B inches	ORDER NO. STANDARD	ORDER NO. HIGH	B mm	B inches	ORDER NO. STANDARD	ORDER NO. HIGH
3		184.032.00		12		184.122.00	184.122.00H
4		184.042.00		12,7	1/2	184.128.00	
5		184.052.00		14		184.142.00	
6		184.062.00	184.062.00H	16	5/8	184.162.00	184.162.00H
6,35	1/4	184.064.00		18		184.182.00	
7		184.072.00		19	3/4	184.192.00	
8	5/16	184.082.00	184.082.00H	20		184.202.00	184.202.00H
9,52	3/8	184.096.00		25		184.252.00	184.252.00H
10		184.102.00					

BULK PACK 10 PCS.

Precision Collets "DIN6388"

185 TECHNICAL DETAILS:

Replaceable **Standard Precision 0.015** collets. 0; -0,7mm wide clamping tolerance.
Suitable for most conical chucks. Fit most tapered spindle noses.

☐ Special dimensions available on request.



EOC25

mm	B inches		ORDER NO.	mm	B inches		ORDER NO.
3		10	185.030.00	12		10	185.120.00
4		10	185.040.00	12,7	1/2	10	185.127.00
5		10	185.050.00	14		10	185.140.00
6		10	185.060.00	16	5/8	10	185.160.00
6,35	1/4	10	185.064.00	18		10	185.180.00
8	5/16	10	185.080.00	19	3/4	10	185.191.00
9,5	3/8	10	185.095.00	20		10	185.200.00
10		10	185.100.00	25		10	185.250.00

EOC16

mm	B inches		ORDER NO.	mm	B inches		ORDER NO.
6		10	185.060.16	12		10	185.120.16
8	5/16	10	185.080.16	14		10	185.140.16
10		10	185.100.16	16	5/8	10	185.160.16

Clamping Nuts



992.583 FOR «ER25»

RH LH

DESCRIPTION	D mm	S mm		ORDER NO. Right-hand rotation	ORDER NO. Left-hand rotation
Clamping nut without bearing					
Clamping nut with bearing ER25	42	M32x1,5	1	992.583.01	992.583.02

992.183 FOR «ER32»

RH LH

DESCRIPTION	D mm	S mm		ORDER NO. Right-hand rotation	ORDER NO. Left-hand rotation
Clamping nut without bearing					
For 183.000/100/200/250/300/400 chucks	50	M40x1,5	1	992.183.01	992.183.02
Clamping nut with bearing					
For 183.000/100/200/250/300/400 chucks	50	M40x1,5	1	992.183.11	992.183.12

992.383 FOR «ER40»

RH LH

DESCRIPTION	D mm	S mm		ORDER NO. Right-hand rotation	ORDER NO. Left-hand rotation
Clamping nut without bearing					
For 183.201/211/221/310 chucks	63	M50x1,5	1	992.383.01	992.383.02
Clamping nut with bearing					
For 183.201/211/221/310 chucks	63	M50x1,5	1	992.383.11	

992.283 FOR «EOC25»

RH

DESCRIPTION	D mm	S mm		ORDER NO. Right-hand rotation
Clamping nut without bearing for chuck 183.320	60	M48x2	1	992.283.01
Clamping nut with bearing for chuck 183.320	60	M48x2	1	992.283.11

ISO30 Retaining Studs



995.200 995.201 995.202 995.250 995.400

995

DESCRIPTION	D mm	D ₂ mm	ORDER NO.
For 183.200/201 BIESSE® chucks	8	12,8	995.200.00
For 183.210/211 BIESSE®, OMLAT®, NUOVA BULLERI BREVETTI®, BUSELLATO®, WEEKE®, IMA® chucks	9	13	995.201.00
For 183.220/221 ALBERTI® - MASTERWOOD® chucks	9	12,8	995.202.00
For 183.250/251 SCM® - MORBIDELLI® chucks	6,5	8,5	995.250.00
For LEUCO® P-SYSTEM® 183.400 chucks	M8		995.400.00

C-Spanner

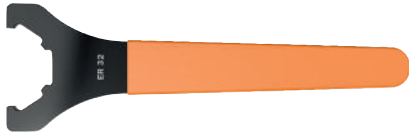

991.183 FOR «ER32»

DESCRIPTION	ORDER NO.
C-Spanner for "ER32"	991.183.00

991.184 FOR «ER40»

DESCRIPTION	ORDER NO.
C-Spanner for "ER40"	991.184.00



991.283 FOR «DIN6388» AND «ER40»

DESCRIPTION	ORDER NO.
C-Spanner for 58-62-65	991.283.00

Saw Blade Arbor with Parallel Shank

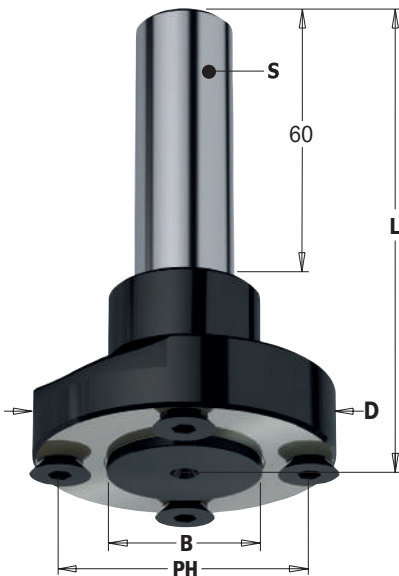

183.410

S mm	D mm	B mm	PIN HOLE	L mm	ORDER NO.
20	59	30	4/M6/48	97,5	183.410.30

Spare parts: **990.116.00** M6x8,7x12mm TSPEI screw (to use with Plate Thickness ≥ 2,2mm)
991.067.00 3mm hex key
991.064.00 4mm hex key



Optional: **990.083.00** M6x8x10mm TSPEI screw (to use with Plate Thickness < 2,2mm)

SAFETY TIPS



The **TW-006** Torque Screwdriver is recommended for the proper fastening of screws (see page 413).

Grooving saw blades available at page 66 on request.

LH RH

HSK Chucks for Grooving Blade

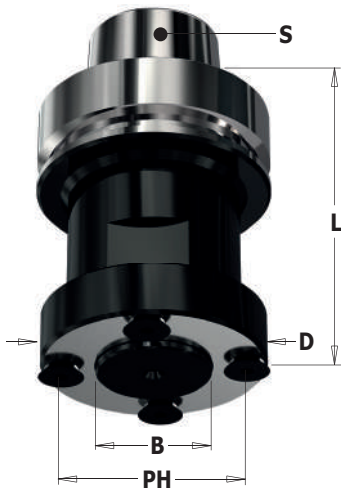

183.420

LH RH

S	D mm	B mm	PIN HOLE	L mm		ORDER NO.
HSK-63F	59	30	4/M6/48	78	1	183.420.30

Spare parts: 990.116.00 M6x8,7x12mm TSPEI screw
991.064.00 4mm hex key



Max saw blade \varnothing 250mm for chuck 183.420.30

Do not exceed maximum RPM indicated on the blade.

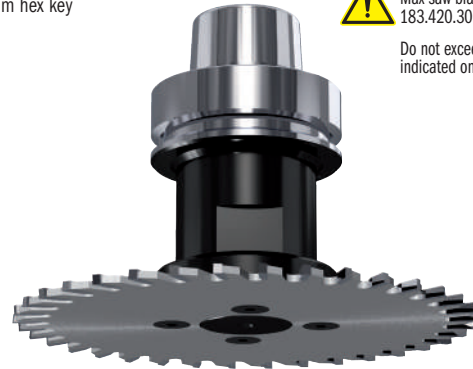

Grooving saw blades available at page 66 on request.

SAFETY TIPS



The **TW-006** Torque Screwdriver is recommended for the proper fastening of screws (see page 413).

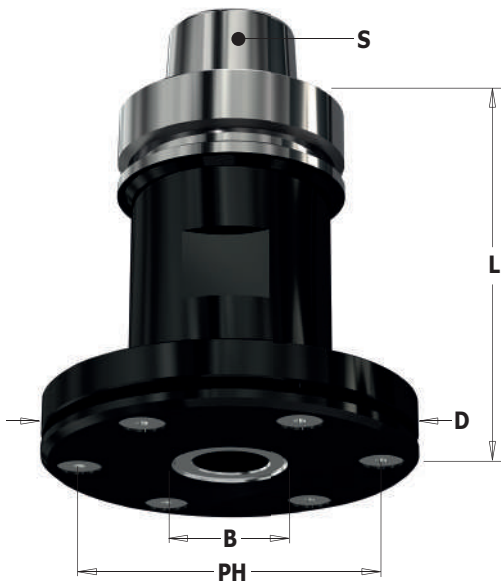

183.421

LH RH

S	D mm	B mm	PIN HOLE	L mm		ORDER NO.
HSK-63F	98	30	6/M6/80	94	1	183.421.30

Spare parts: 990.119.00 M6x12x16mm TSPEI screw
991.064.00 4mm hex key



Max saw blade \varnothing 300mm for chuck 183.421.30

Do not exceed maximum RPM indicated on the blade.

with flange \varnothing 98mm



Grooving saw blades available on request.

SAFETY TIPS



The **TW-006** Torque Screwdriver is recommended for the proper fastening of screws (see page 413).

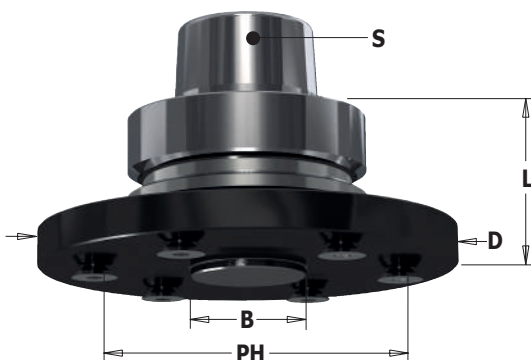

183.422

LH RH

S	D mm	B mm	PIN HOLE	L mm		ORDER NO.
HSK-63F	110	30	6/M6/80	40	1	183.422.30

Spare parts: 990.116.00 M6x8,7x12mm TSPEI screw
991.064.00 4mm hex key



Max saw blade \varnothing 350mm for chuck 183.422.30

Do not exceed maximum RPM indicated on the blade.



Grooving saw blades available on request.

SAFETY TIPS



The **TW-006** Torque Screwdriver is recommended for the proper fastening of screws (see page 413).

Cutter Arbor Chucks with Tapered Shank

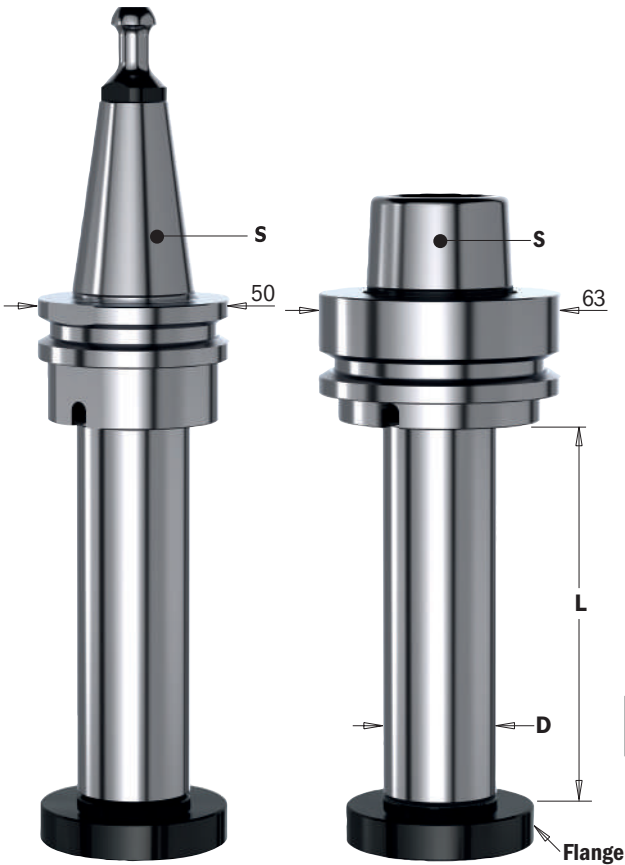

183.260

LH RH

S	DESCRIPTION	D x L mm		ORDER NO.
ISO30	Cutter arbor with ISO30 tapered shank	30x100	1	183.260.00

For BIESSE® machines.

REMARK: special dimensions available on request.

183.360

LH RH

S	DESCRIPTION	D x L mm		ORDER NO.
HSK-63F	Cutter arbor with HSK tapered shank	30x100	1	183.360.00
HSK-63F	Cutter arbor with HSK tapered shank	30x150	1	183.360.10
HSK-63F	Cutter arbor with HSK tapered shank	35x100	1	183.361.00
HSK-63F	Cutter arbor with HSK tapered shank	40x100	1	183.362.00

For HOMAG®, EIMA®, IMA® FROM 9/94, WEEKE®, BIESSE®, SCM®, MORBIDELLI® and MASTERWOOD® machines.

SAFETY TIPS



The **TW-006** Torque Screwdriver is recommended for the proper fastening of screws (see page 413).

Spare Parts for Cutter Arbor Chucks

Standard



Optional



DESCRIPTION	ORDER NO.	DESCRIPTION	ORDER NO.
M6x25 TCEI screw	990.098.00	Optional Steel Flange	
Steel flange for with Ø30mm arbors - Male	992.560.30M	For with Ø30mm arbors - Female	992.560.30F
Steel flange for with Ø35mm arbors - Male	992.560.35M	For with Ø35mm arbors - Female	992.560.35F
Steel flange for with Ø40mm arbors - Male	992.560.40M	For with Ø40mm arbors - Female	992.560.40F

Universal Assembly Supports for Chucks

183



SUITABLE FOR	D mm		ORDER NO.
HSK-63, BT40, ISO40 DIN 2080, SK40 DIN 69871, CAPTO® C6	63	1	183-HSK
ISO30, DIN 2080, SK30 DIN 69871, HSK50, CAPTO® C5	50	1	183-ISO*

*Not compatible with chucks **183.250** and **183.251**

CMT now offers new universal assembly supports for HSK-63F and ISO30 chucks. Thanks to the bi-directional roller bearings, which clamp the Left-hand rotation to the flange, the system offers the highest protection to the tool taper and clamps are no longer needed.

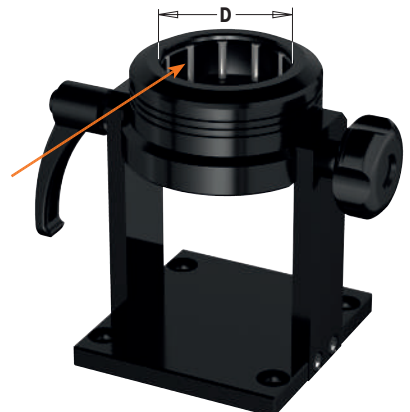



X-TREME COATING

THE ULTIMATE TECHNOLOGY FOR INDUSTRIAL CNC TOOLS

DLCS is a modified diamond-like carbon coating with superior load bearing capacity. This hard, durable metal-based finish (chromium nitride) provides an higher hardness surface and enhances the tribological properties of the carbon coating. Its application prevents excessive heat build up which is detrimental to performance. This means cutting tools remain fully effective after every use.

<p>Extreme Coating Hardness >HV 2.500</p> <p>Offers impressive hardness on cutting edges as well as outstanding protection against wear and tear.</p>	<p>Minimal coating thickness µm 2-4</p> <p>This micron thin finish guarantees perfectly sharpened edges for high cutting quality.</p>	<p>Provides the lowest coefficient of friction 0,1-0,2</p> <p>Very good running-in and low friction losses. Reduction of sticking. Ideal for high speeds in Nesting applications.</p>	<p>Optimal resistance to heat build up</p> <p>Reduced overheating. Cutting edges resist excessive wear up to 400°C.</p>
----------------------------------------------------------------------------------------------------------------------------------------------------------------------------	---------------------------------------------------------------------------------------------------------------------------------------------------------	---------------------------------------------------------------------------------------------------------------------------------------------------------------------------------------------------------	--------------------------------------------------------------------------------------------------------------------------------

BENEFITS



3X
LONGER LIFE
THAN UNCOATED

DLCS CHROME COATING

PROVIDES 3 TIMES LONGER LIFE THAN UNCOATED TOOLS!



Test performed in U.S. with 1/2" solid carbide compression spiral bit

- MACHINE:** FELDER® Profit H10 Nested Base/Overhead CNC Router
- WORKING PARAMETERS:** RPM = 18,000 - Feed = 20 mts/minute
- MATERIAL:** 19mm Melamine Chipboard
- APPLICATION:** Nesting Full Dimensioning
- PERFORMANCE:** DLCS coated bit cut 165 melamine panels
Uncoated bit cut 56 melamine panels

FELDER® Profit H10



DLCS coated bit



Melamine Chipboard



Cut quality after 165 panels

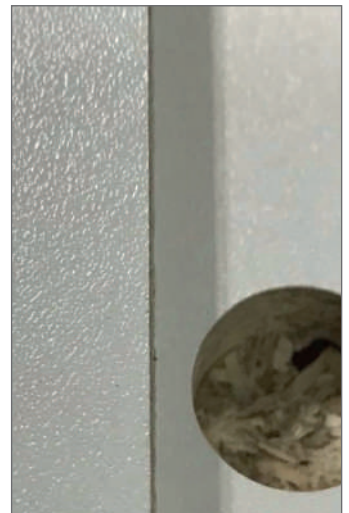



190.41 DLCS CHROME COATING



D mm	I mm	I ₁ mm	L mm	S mm	Z		ORDER NO. Right-hand rotation
8	32	7	80	8	2+2	10	190.080.41
9,52	28,6	7	76,2	9,52	2+2	10	190.504.41
10	32	7	80	10	2+2	10	190.100.41
10	42	7	90	10	2+2	10	190.101.41
12	42	7	90	12	2+2	10	190.120.41
12	52	7	100	12	2+2	10	190.121.41
12,7	25,4	12	76,2	12,7	2+2	10	190.505.41
12,7	28,6	12	76,2	12,7	2+2	10	190.506.41
12,7	34,9	12	88,9	12,7	2+2	10	190.507.41
12,7	41,3	12	101,6	12,7	2+2	10	190.508.41

...UP & DOWNCUT MORTISING BITS

9,52	22,2	4,8	76,2	9,52	2+2	10	190.513.41
9,52	25,4	5,2	76,2	9,52	3+3	10	190.813.41
12	25	5,2	83	12	3+3	10	190.320.41
12,7	22,2	5,2	76,2	12,7	2+2	10	190.515.41
12,7	34,9	5,2	88,9	12,7	2+2	10	190.517.41
12,7	28,5	6	76,2	12,7	3+3	10	190.815.41



190



D mm	I mm	I ₁ mm	L mm	S mm	Z		ORDER NO. Right-hand rotation
4	15	5	50	4	1+1	10	190.040.11
5	22	8	60	5	1+1	10	190.050.11
6	22	8	60	6	1+1	10	190.060.11
6,35	22,2	7	63,5	6,35	2+2	10	190.008.11
8	32	7	80	8	2+2	10	190.080.11
9,52	28,6	7	76,2	9,52	2+2	10	190.504.11
10	32	7	80	10	2+2	10	190.100.11
10	42	7	90	10	2+2	10	190.101.11
12	42	7	90	12	2+2	10	190.120.11
12	52	7	100	12	2+2	10	190.121.11
12,7	25,4	12	76,2	12,7	2+2	10	190.505.11
12,7	28,6	12	76,2	12,7	2+2	10	190.506.11
12,7	34,9	12	88,9	12,7	2+2	10	190.507.11
12,7	41,3	12	101,6	12,7	2+2	10	190.508.11
16	55	24	110	16	2+2	10	190.160.11
18	55	30	110	18	2+2	10	190.180.11

...UP & DOWNCUT MORTISING BITS

9,52	22,2	4,8	76,2	9,52	2+2	10	190.513.11
9,52	25,4	5,2	76,2	9,52	3+3	10	190.813.11
12	25	5,2	83	12	3+3	10	190.320.11
12,7	22,2	5,2	76,2	12,7	2+2	10	190.515.11
12,7	34,9	5,2	88,9	12,7	2+2	10	190.517.11
12,7	28,5	6	76,2	12,7	3+3	10	190.815.11

TECHNICAL DETAILS:

- Premium quality HWM.
- 1+1 spiral cutting edges [Z1+1].
- 2+2 spiral cutting edges [Z2+2].
- 3+3 spiral cutting edges [Z3+3].
- Provide an excellent finish on both the upper and the lower side of the workpiece.

APPLICATION:

used for efficient contour cutting, end-trimming and panel sizing on solid wood, wood composites, plastic materials and laminates at high feed speed. Ensure to properly clamp workpieces. Can be used on machining centres, point-to-point boring machines, CNC routers and hand-held routers equipped with chucks or adaptors.



Results shown in this diagram are purely empirical, based merely on informative and hypothetical calculation. Each application may require different parameters in consideration of materials in use and machining conditions. CMT is not responsible for direct, indirect, incidental or consequential damages resulting from any defect, error or failure due to this diagram.

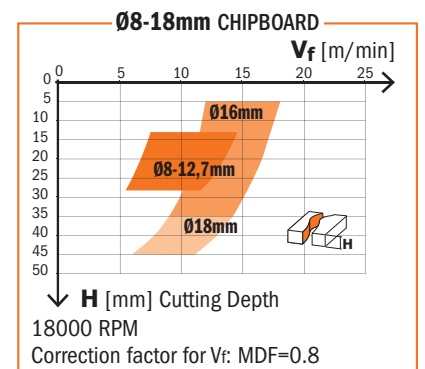
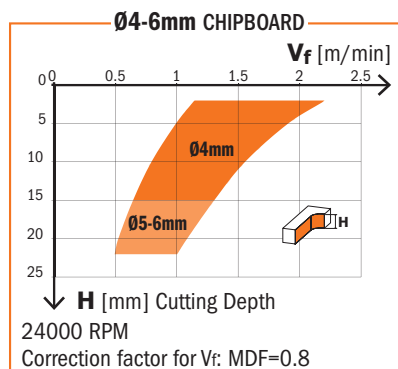



198 UPCUT SPIRAL



D mm	I mm	L mm	S mm		ORDER NO. Right-hand rotation
3	12	50	3	10	198.030.11
3,18	12,7	50,8	6,35	10	198.001.11
4	15	50	4	10	198.040.11
4,76	15,87	50,8	6,35	10	198.005.11
5	17	50	5	10	198.050.11
6	22	60	6	10	198.060.11
6,35	19,05	50,8	6,35	10	198.007.11
6,35	25,4	63,5	6,35	10	198.008.11
8	22	70	8	10	198.080.11
8	32	80	8	10	198.081.11
9,52	28,57	76,2	9,52	10	198.504.11
10	32	70	10	10	198.100.11
10	42	80	10	10	198.101.11
10	52	90	10	10	198.102.11
12	32	83	12	10	198.120.11

TECHNICAL DETAILS:

- Premium quality HWM.
- 1 spiral cutting edge [Z1].
- **Provide an excellent finish on the lower side of the workpiece.**
- Upward chip ejection.

APPLICATION:

used for efficient contour cutting, end-trimming and panel sizing on solid wood, wood composites, plastic materials and laminates at high feed speed. Ensure to properly clamp workpieces.
Can be used on machining centres, point-to-point boring machines, CNC routers and hand-held routers equipped with chucks or adaptors.



198 DOWNCUT SPIRAL



D mm	I mm	L mm	S mm		ORDER NO. Right-hand rotation
6	27	60	6	10	198.660.11

TECHNICAL DETAILS:

- Premium quality HWM.
- 1 spiral cutting edge [Z1].
- **Provide an excellent finish on the top side of the workpiece.**
- Downward chip ejection.

APPLICATION:

used for efficient contour cutting, end-trimming and panel sizing on solid wood, wood composites, plastic materials and laminates at high feed speed. Ensure to properly clamp workpieces.
Can be used on machining centres, point-to-point boring machines, CNC routers and hand-held routers equipped with chucks or adaptors.

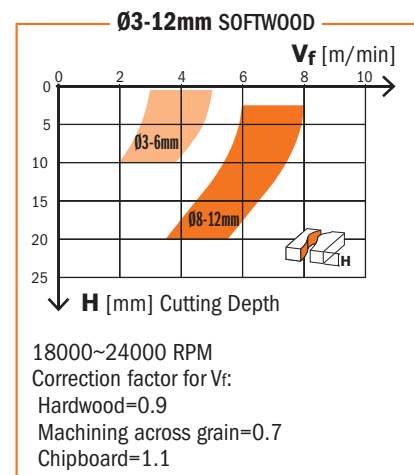
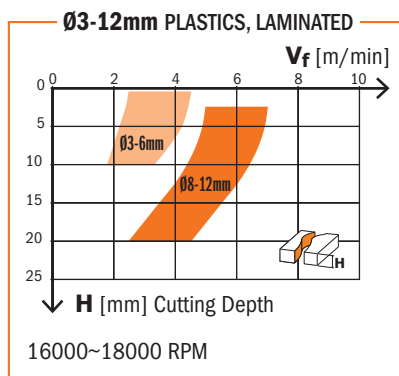

Results shown in this diagram are purely empirical, based merely on informative and hypothetical calculation. Each application may require different parameters in consideration of materials in use and machining conditions. CMT is not responsible for direct, indirect, incidental or consequential damages resulting from any defect, error or failure due to this diagram.



191



D mm	I mm	L mm	S mm		ORDER NO. Right-hand rotation
3	12	50	3	10	191.030.11
3	12	60	6	10	191.630.11
3	12	60	8	10	191.830.11
3,18	12,7	50,8	6,35	10	191.001.11
3,5	12	60	6	10	191.635.11
3,97	12,7	50,8	6,35	10	191.003.11
4	15	50	4	10	191.040.11
4	15	60	6	10	191.640.11
4	15	60	8	10	191.840.11
4,76	19,05	50,8	6,35	10	191.005.11
5	17	50	5	10	191.050.11
5	17	60	6	10	191.650.11
5	17	60	8	10	191.850.11
6	27	70	6	10	191.060.11
6	27	70	8	10	191.860.11
6,35	19,05	50,8	6,35	10	191.007.11
6,35	25,4	63,5	6,35	10	191.008.11
7	32	80	8	10	191.870.11
7,94	25,4	76,2	12,7	10	191.501.11
8	22	70	8	10	191.080.11
8	32	80	8	10	191.081.11
8	42	90	8	10	191.082.11
9	32	83	12	10	191.890.11
9,52	31,75	82,5	12,7	10	191.503.11
10	32	80	8	10	191.800.11
10	32	80	10	10	191.100.11
10	32	83	12	10	191.900.11
10	42	90	10	10	191.101.11
10	42	90	12	10	191.901.11
12	35	83	8	10	191.820.11
12	35	83	12	10	191.120.11
12	42	90	12	10	191.121.11
12	52	100	12	10	191.122.11
12,7	31,75	76,2	12,7	10	191.505.11
12,7	38,1	88,9	12,7	10	191.506.11
12,7	50,8	101,6	12,7	10	191.507.11
14	50	110	14	1	191.140.11
16	55	110	16	1	191.160.11
16	35	90	16	1	191.161.11
16	72	120	16	1	191.165.11
20	72	120	20	1	191.200.11

Ø12-14mm PLASTICS, LAMINATED

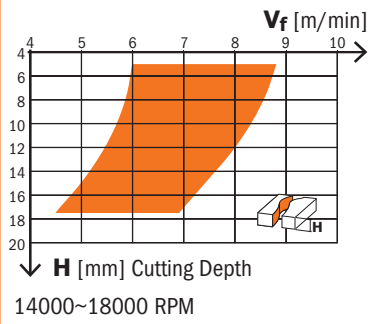

Ø12-20mm SOFTWOOD

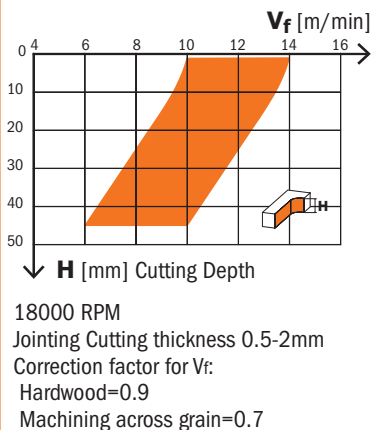

TECHNICAL DETAILS:

- Premium quality HWM.
- 2 spiral cutting edges [Z2].
- **Provide an excellent finish on the lower side of the workpiece.**
- Upward chip ejection.

APPLICATION:

used for efficient contour cutting, end-trimming and panel sizing on solid wood, wood composites, plastic materials and laminates at high feed speed. Ensure to properly clamp workpieces.

Can be used on machining centres, point-to-point boring machines, CNC routers and hand-held routers equipped with chucks or adaptors.



Results shown in this diagram are purely empirical, based merely on informative and hypothetical calculation. Each application may require different parameters in consideration of materials in use and machining conditions. CMT is not responsible for direct, indirect, incidental or consequential damages resulting from any defect, error or failure due to this diagram.

Solid Carbide Downcut Spiral Bits - LONG LIFE

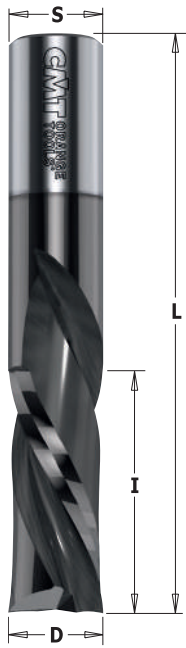

192.41 DLCS CHROME COATING



D mm	I mm	L mm	S mm		ORDER NO. Right-hand rotation
6,35	19,05	50,8	6,35	10	192.007.41
6,35	25,4	63,5	6,35	10	192.008.41
9,52	31,75	82,5	12,7	10	192.503.41
12,7	31,75	76,2	12,7	10	192.505.41
12,7	38,1	88,9	12,7	10	192.506.41
12,7	50,8	101,6	12,7	10	192.507.41

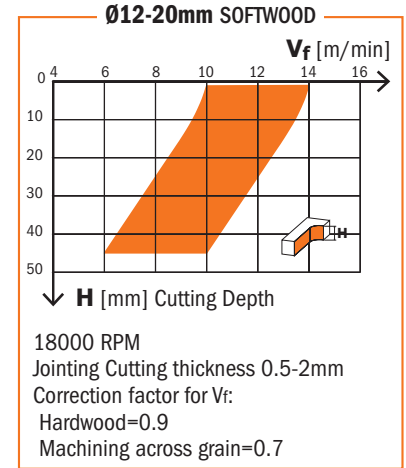
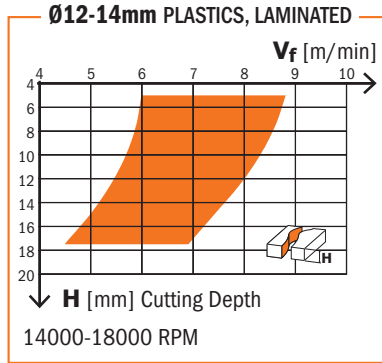

Results shown in this diagram are purely empirical, based merely on informative and hypothetical calculation. Each application may require different parameters in consideration of materials in use and machining conditions. CMT is not responsible for direct, indirect, incidental or consequential damages resulting from any defect, error or failure due to this diagram.

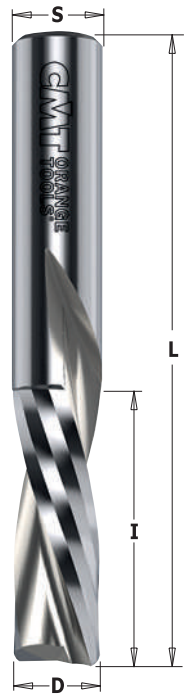

192



D mm	I mm	L mm	S mm		ORDER NO. Right-hand rotation
3	12	50	3	10	192.030.11
3	12	60	6	10	192.630.11
3	12	60	8	10	192.830.11
3,18	12,7	50,8	6,35	10	192.001.11
3,97	12,7	50,8	6,35	10	192.003.11
4	15	50	4	10	192.040.11
4	15	60	6	10	192.640.11
4	15	60	8	10	192.840.11
4,76	19,05	50,8	6,35	10	192.005.11
5	17	50	5	10	192.050.11
5	17	60	6	10	192.650.11
5	17	60	8	10	192.850.11
6	27	70	6	10	192.060.11
6	27	70	8	10	192.860.11
6,35	19,05	50,8	6,35	10	192.007.11
6,35	25,4	63,5	6,35	10	192.008.11
7,94	25,4	76,2	12,7	10	192.501.11
8	22	70	8	10	192.080.11
8	32	80	8	10	192.081.11
8	42	90	8	10	192.082.11
9,52	31,75	82,5	12,7	10	192.503.11
10	32	80	8	10	192.800.11
10	32	80	10	10	192.100.11
10	42	90	10	10	192.101.11
10	32	83	12	10	192.900.11
12	35	83	8	10	192.820.11
12	35	83	12	10	192.120.11
12,7	31,75	76,2	12,7	10	192.505.11
12,7	38,1	88,9	12,7	10	192.506.11
12,7	50,8	101,6	12,7	10	192.507.11
14	52	110	14	1	192.140.11
16	55	110	16	1	192.160.11

TECHNICAL DETAILS:

- Premium quality HWM.
- 2 spiral edges [Z2].
- Provide an excellent finish on the upper side of the workpiece.
- Downward chip ejection.

APPLICATION:

used for efficient contour cutting, end-trimming and panel sizing on solid wood, wood composites, plastic materials and laminates at high feed speed. Ensure to properly clamp workpieces. Can be used on machining centres, point-to-point boring machines, CNC routers and hand-held routers equipped with chucks or adaptors.

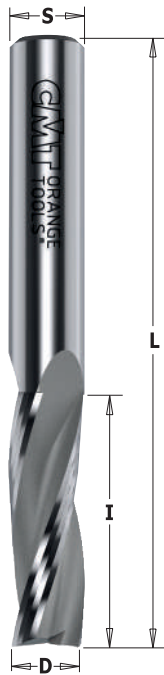

193



D mm	I mm	L mm	S mm		ORDER NO. Right-hand rotation	ORDER NO. Left-hand rotation
8	32	80	8	10	193.081.11	193.081.12
10	32	80	10	10	193.100.11	193.100.12
10	42	90	10	10	193.101.11	
12	35	83	12	10	193.120.11	193.120.12
12	42	90	12	10	193.121.11	
12	52	100	12	10	193.122.11	
14	58	110	14	1	193.140.11	
16	55	110	16	1	193.160.11	193.160.12
16	35	90	16	1	193.161.11	
16	72	120	16	1	193.165.11	
18	55	110	18	1	193.180.11	
20	60	120	20	1	193.200.11	193.200.12
20	70	120	20	1	193.201.11	
20	102	165	20	1	193.202.11	

TECHNICAL DETAILS:

- Premium quality HWM.
- 3 spiral cutting edges [Z3].
- **Provide an excellent finish on the lower side of the workpiece.**
- Upward chip ejection.

APPLICATION:

used for efficient contour cutting, end-trimming and panel sizing on solid wood, wood composites, plastic materials and laminates at high feed speed. Ensure to properly clamp workpieces. Can be used on machining centres, point-to-point boring machines, CNC routers and hand-held routers equipped with chucks or adaptors.

Ø12-14mm PLASTICS, LAMINATED

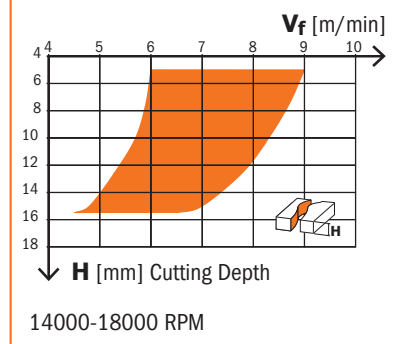

Ø12-20mm SOFTWOOD

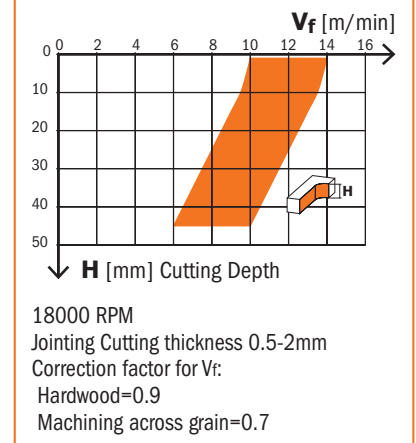

Results shown in this diagram are purely empirical, based merely on informative and hypothetical calculation. Each application may require different parameters in consideration of materials in use and machining conditions. CMT is not responsible for direct, indirect, incidental or consequential damages resulting from any defect, error or failure due to this diagram.

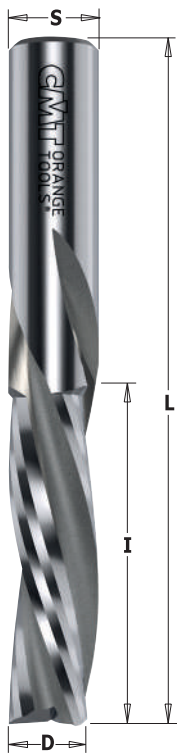

194



D mm	I mm	L mm	S mm		ORDER NO. Right-hand rotation	ORDER NO. Left-hand rotation
10	32	80	10	10	194.100.11	
10	42	90	10	10	194.101.11	
12	35	83	12	10	194.120.11	194.120.12
12	42	90	12	10	194.121.11	
14	50	110	14	1	194.140.11	
16	55	110	16	1	194.160.11	194.160.12
16	35	90	16	1	194.161.11	
18	55	110	18	1	194.180.11	
20	60	120	20	1	194.200.11	194.200.12
20	72	140	20	1	194.201.11	
20	102	165	20	1	194.202.11	

TECHNICAL DETAILS:

- Premium quality HWM.
- 3 spiral cutting edges [Z3].
- **Provide an excellent finish on the upper side of the workpiece.**
- Downward chip ejection.

APPLICATION:

used for efficient contour cutting, end-trimming and panel sizing on solid wood, wood composites, plastic materials and laminates at high feed speed. Ensure to properly clamp workpieces. Can be used on machining centres, point-to-point boring machines, CNC routers and hand-held routers equipped with chucks or adaptors.

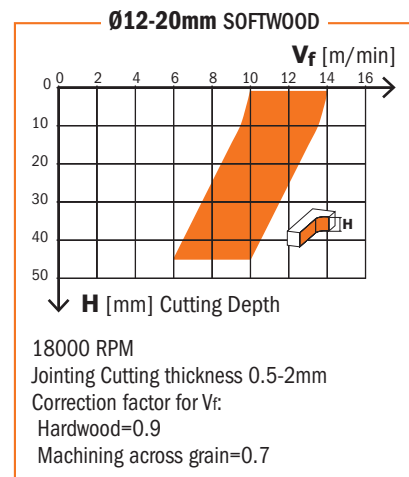
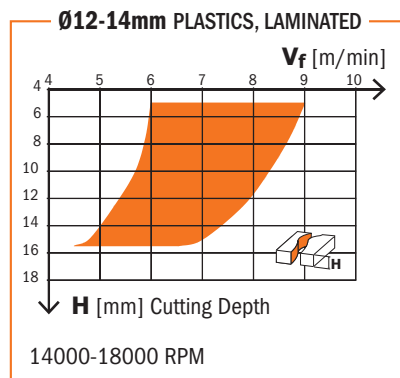

Results shown in this diagram are purely empirical, based merely on informative and hypothetical calculation. Each application may require different parameters in consideration of materials in use and machining conditions. CMT is not responsible for direct, indirect, incidental or consequential damages resulting from any defect, error or failure due to this diagram.

Solid Carbide Upcut Spiral Bits with Chipbreaker



195



D mm	I mm	L mm	S mm		ORDER NO. Right-hand rotation	ORDER NO. Left-hand rotation
8	32	80	8	10	195.081.11	195.081.12
8	42	90	8	10	195.082.11	
10	32	80	10	10	195.100.11	195.100.12
10	42	90	10	10	195.101.11	
12	35	83	12	10	195.120.11	195.120.12
12	42	90	12	10	195.121.11	
12	52	100	12	10	195.122.11	
12,7	38,1	88,9	12,7	10	195.506.11	
14	58	110	14	1	195.140.11	
16	55	110	16	1	195.160.11	195.160.12
16	35	90	16	1	195.161.11	
16	72	120	16	1	195.165.11	
18	55	110	18	1	195.180.11	
20	60	120	20	1	195.200.11	195.200.12
20	72	120	20	1	195.201.11	
20	102	165	20	1	195.202.11	

TECHNICAL DETAILS:

- Premium quality HWM.
- 3 spiral cutting edges [Z3R].
- Chipbreaker teeth.
- Max 0.3mm tooth depth.
- **Provide an excellent finish on the lower side of the workpiece.**
- Upward chip ejection.

APPLICATION:

used for efficient contour cutting, end-trimming and panel sizing on solid wood, wood composites, plastic materials and laminates at high feed speed. Ensure to properly clamp workpieces. Can be used on machining centres, point-to-point boring machines, CNC routers and hand-held routers equipped with chucks or adaptors.

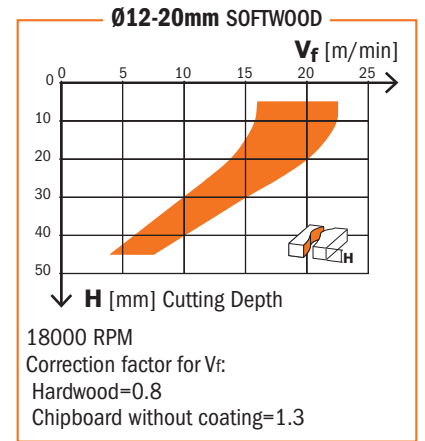
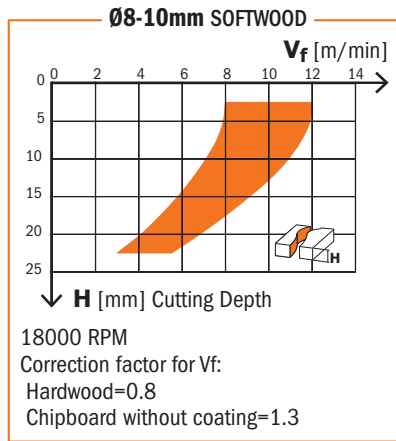

Results shown in this diagram are purely empirical, based merely on informative and hypothetical calculation. Each application may require different parameters in consideration of materials in use and machining conditions. CMT is not responsible for direct, indirect, incidental or consequential damages resulting from any defect, error or failure due to this diagram.

Solid Carbide Upcut Spiral Bits

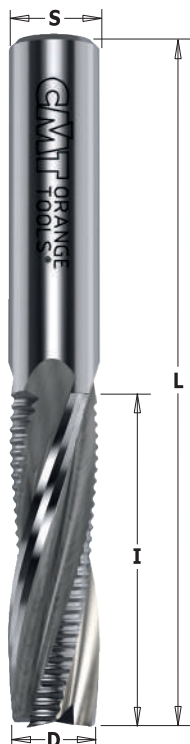

197



D mm	I mm	L mm	S mm		ORDER NO. Right-hand rotation	
12	42	90	12	10	197.121.11	
14	50	110	14	1	197.140.11	
16	55	110	16	1	197.160.11	
16	35	90	16	1	197.161.11	
18	55	110	18	1	197.180.11	
20	60	120	20	1	197.200.11	
20	72	120	20	1	197.201.11	

TECHNICAL DETAILS:

- Premium quality HWM.
- 4 spiral cutting edges (2 with chipbreaker) [Z2+2R].
- Max 0.1mm tooth depth.
- **Provide excellent finish on the lower side of the workpiece.**
- Upward chip ejection.

APPLICATION:

used for efficient contour cutting, end-trimming and panel sizing on solid wood and wood composites. Can be used on machining centres, point-to-point boring machines, CNC routers and hand-held routers equipped with chucks or adaptors.



The special 4 flute design (Z2 finishing + Z2R with chipbreaker) allows high speed with excellent finish on the workpiece.

Solid Carbide Downcut Spiral Bits with Chipbreaker

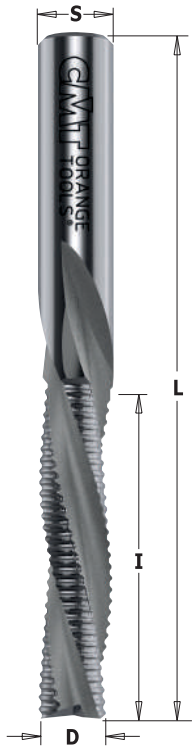

196



D mm	I mm	L mm	S mm		ORDER NO. Right-hand rotation	ORDER NO. Left-hand rotation
8	32	80	8	10	196.081.11	
10	42	90	10	10	196.101.11	
12	35	83	12	10	196.120.11	196.120.12
12	42	90	12	10	196.121.11	
12	52	100	12	10	196.122.11	
12,7	38,1	88,9	12,7	10	196.506.11	
14	50	110	14	1	196.140.11	
16	55	110	16	1	196.160.11	196.160.12
18	55	110	18	1	196.180.11	
20	60	120	20	1	196.200.11	
20	72	140	20	1	196.201.11	

TECHNICAL DETAILS:

- Premium quality HWM.
- 3 spiral cutting edges [Z3R].
- Chipbreaker teeth.
- Max 0.3mm tooth depth.
- **Provide excellent finish on the upper side of the workpiece.**
- Downward chip ejection.

APPLICATION:

used for efficient contour cutting, end-trimming and panel sizing on solid wood, wood composites, plastic materials and laminates at high feed speed. Ensure to properly clamp workpieces. Can be used on machining centres, point-to-point boring machines, CNC routers and hand-held routers equipped with chucks or adaptors.

Ø8-10mm SOFTWOOD

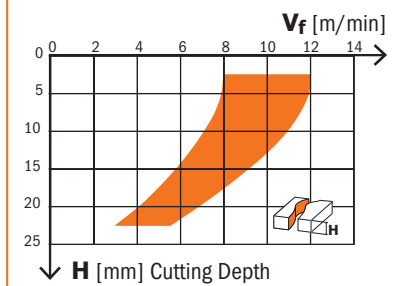

18000 RPM
Correction factor for Vr:
Hardwood=0.8
Chipboard without coating=1.3

Ø12-20mm SOFTWOOD

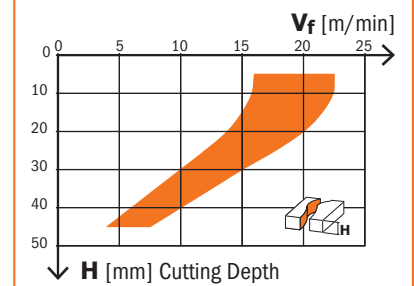

18000 RPM
Correction factor for Vr:
Hardwood=0.8
Chipboard without coating=1.3

Results shown in this diagram are purely empirical, based merely on informative and hypothetical calculation. Each application may require different parameters in consideration of materials in use and machining conditions. CMT is not responsible for direct, indirect, incidental or consequential damages resulting from any defect, error or failure due to this diagram.

Solid Carbide Upcut & Downcut Spiral Bit with DLCS Chrome Coating - LONG LIFE



190.04

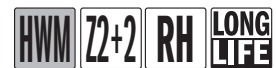

D mm	d mm	I mm	L mm	S mm	Z		ORDER NO. Right-hand rotation
9,8	7	25	83	12	2+2	10	190.001.04

LAMELLO® P-SYSTEM® components can be crafted on a CNC machining center. Groovework is carried out along the edge workpiece with a spiral cutter coated with DLCS for long life.



For use only on 5 axis CNC machines.

P-System



1



2



3



4



Solid Carbide Upcut Spiral Bits for Locksets



195



D mm	I mm	I ₁ mm	L mm	S mm		ORDER NO. Right-hand rotation
WITH CHIPBREAKER						
14	95*	45	150	14	1	195.142.11
14	125*	45	170	14	1	195.144.11
16	95*	45	150	16	1	195.162.11
16	120*	50	170	16	1	195.164.11
18	95*	45	150	18	1	195.182.11
WITHOUT CHIPBREAKER						
16	95*	45	150	16	1	193.162.11

* The maximum cutting length is achieved in 2-3 passes.

TECHNICAL DETAILS:

- Premium quality HWM.
- 3 spiral cutting edges [Z3] and [Z3R].
- Max 0.3mm tooth depth.
- **Provide an excellent finish on the lower side of the workpiece.**
- Seat for seeger ring (*not included*).
- Upward chip ejection.

APPLICATION:

used for efficient contour cutting, end-trimming and panel sizing on solid wood, wood composites, plastic materials and laminates at high feed speed. Ensure to properly clamp workpieces. Can be used on machining centres, point-to-point boring machines, CNC routers and hand-held routers equipped with chucks or adaptors.

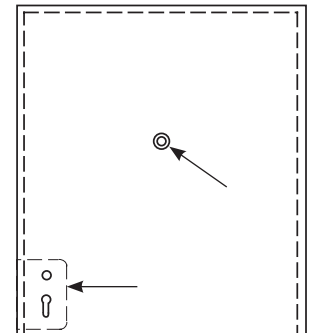
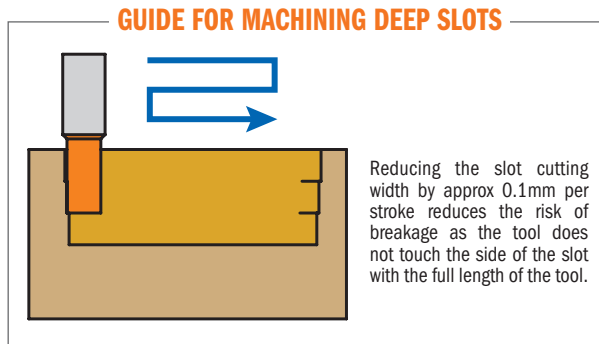

Solid Carbide Upcut Spiral Bits with Chipbreaker for 60° V-Point Locksets



195.143/163

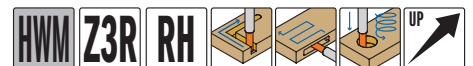

D mm	I mm	L mm	S mm		ORDER NO. Right-hand rotation
14	58	110	14	1	195.143.11
16	55	110	16	1	195.163.11

Solid Carbide Upcut Spiral Bits without Chipbreaker for 60° V-Point Locksets

191.143/163

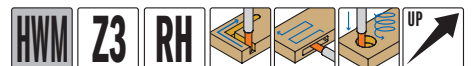

D mm	I mm	L mm	S mm		ORDER NO. Right-hand rotation
14	50	110	14	1	191.143.11
16	55	110	16	1	191.163.11

TECHNICAL DETAILS:

- Premium quality HWM.
- 3 spiral cutting edges [Z3].
- **Provide an excellent finish on the lower side of the workpiece.**
- Upward chip ejection.

APPLICATION:

used for efficient contour cutting, end-trimming and panel sizing on solid wood, wood composites, plastic materials and laminates at high feed speed. Ensure to properly clamp workpieces. Can be used on machining centres, point-to-point boring machines, CNC routers and hand-held routers equipped with chucks or adaptors.

Spiral Bits with Insert Knives & Chipbreaker for Locksets

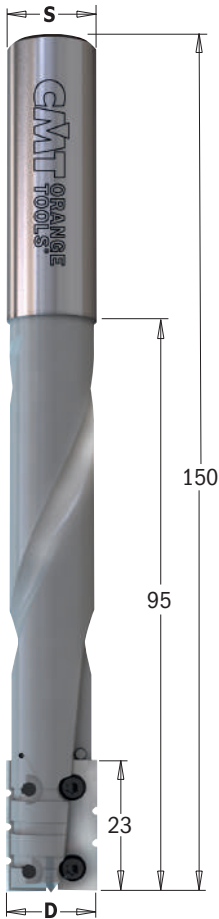

662

D mm	I mm	L mm	S mm		ORDER NO. Right-hand rotation
16	23/95*	150	16	1	662.160.11



Spare parts		
790.230.2R - 790.230.3R	990.082.00	991.063.00

Spare parts: **790.230.2R** 23x7x1.5mm 2-RT HWM K2020 knives (Minimum 10 pieces or multiple)
790.230.3R 23x7x1.5mm 3-RT HWM K2020 knives (Minimum 10 pieces or multiple)

* The 95mm length is achieved in 4-5 passes.

TECHNICAL DETAILS:

- DENSIMET® high density tungsten alloy for low-vibration.
- 2 cutting edges [Z2R] with chipbreakers.

APPLICATION:

used for efficient contour cutting, end-trimming and panel sizing on solid wood, wood composites, plastic materials and laminates at high feed speed. Ensure to properly clamp workpieces. Can be used on machining centres, point-to-point boring machines, CNC routers and hand-held routers equipped with chucks or adaptors. Cost-effective solution with respect to brazed and spiral in tungsten carbide.

SAFETY TIPS

The **TW-006** Torque Screwdriver is recommended for the proper fastening of screws (see page 413).

GUIDE FOR MACHINING DEEP SLOTS

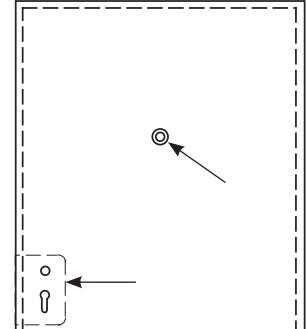
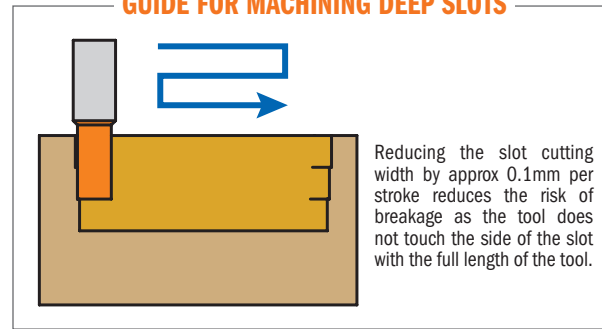

Upcut Spiral Bits with Chipbreaker for Glue-Laminated Wooden Beams



195

D mm	I mm	L mm	S mm		ORDER NO. Right-hand rotation
□ 30	170	235	30	1	Y195.300.51
40	165	235	30	1	195.400.51
50	215	295	30	1	195.500.51

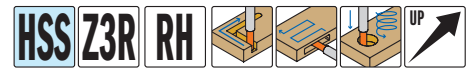

□ On request

Available by special request bits without chipbreaker, with left-hand rotation and/or custom dimensions.

TECHNICAL DETAILS:

- High speed cobalt steel.
- 3 upcut spiral cutting edges with chipbreaker [Z3R].
- Resharpenable cutters.
- Max 6000~10000 RPM.
- Maximum feed speed 2m/minute.
- Upward chip ejection.

APPLICATION:

used for cutting, copying, and routing on glue-laminated wooden beams. For use on HUNDEGGER® machines.

Solid Carbide Upcut 2D/3D Carving Tapered Ball Nose Spiral Bits



152

D mm	R mm	A	I mm	L mm	S mm	Z		ORDER NO. Right-hand rotation
0,8	0,4	5,5°	25	70	6	3	10	152.060.082
0,8	0,4	6,2°	25,4	76,2	6,35	3	10	152.064.082
1,6	0,8	4,5°	25	70	6	3	10	152.060.162
1,6	0,8	5,4°	25,4	76,2	6,35	3	10	152.064.162
1,6	0,8	5,5°	30	80	8	3	10	152.080.163
2	1	3°	80	120	12	2	10	152.120.208
3,2	1,6	2,5°	30	70	6	3	10	152.060.323
3,2	1,6	3,6°	25,4	76,2	6,35	3	10	152.064.322
3,2	1,6	2,5°	50	90	8	3	10	152.080.325
6	3	3°	50	100	12	2	10	152.120.605
6,4	3,2	3°	50,8	101,6	12,7	2	10	152.127.635

TECHNICAL DETAILS:

- Premium quality HWM.
- Upcut spiral cutting edges [Z2/Z3].
- **Excellent finish on the lower side of the work piece.**
- Upward chip ejection.

APPLICATION:

- especially designed for 2D and 3D CNC profiling and carving in plastic, aluminum & wood for several uses like:
- A perfect bit for 3D carving
 - Precision 2D and 3D large scale carving
 - Great for deep profiling
 - Dimensional signage
 - 3D millwork
 - 2D and 3D contouring, profiling, modeling and pattern making for cabinetry, sign making, furniture making and jewelry mold making
 - Perfect for model-makers on large 3D milling profiles in abrasive EPS foam and other materials.
 - **Ideal on aluminum, plastic and wood-based materials.**

EXCELLENCE FOR CUTTING

- Acrylonitrile-Butadiene-Styrene (ABS)
- Acrylic
- Acrylic Stone
- Aluminum
- Brass
- Bronze
- Composite
- Copper
- Ethylene-vinyl Acetate Foam (EVA)
- Expanded Polypropylene (EPP)
- Expanded Polystyrene Foam (EPS)
- Extruded Polystyrene Foam (XPS)
- Fiberglass
- Fiberglass PCB Board
- Foam Board

- Graphite
- HDPE
- HDU
- 20lbs High Density Urethane
- MDF/HDF
- Phenolics
- Phenolic Composites
- Plastics
- Poly (methyl methacrylate) (PMMA)
- Polyethylene Foam
- Polyurethane Foam
- PVC
- PVC Foam Board
- Sign Board
- Sign Foam

- Titanium
- Tooling Board
- Wood
- XPE (Cross Linked Polyethylene) Foam

ALSO EXCELLENCE FOR

- CORIAN®
- COROPLAST®
- DIBOND®
- ETHAFOAM®
- LEXAN®
- PALFOAM®
- POLYLAM®

TIPS FOR MILLING PLASTICS

- pay attention to heat input
- pay attention to chip-loads when using small diameters
- use air-blast to keep chip away and cooling the tool

Round Nose Solid Carbide Upcut Spiral Bits



199



D mm	R mm	I mm	L mm	S mm		ORDER NO. Right-hand rotation
3,18	1,6	12,7	50,8	6,35	10	199.001.11
6	3	27	70	6	10	199.060.11
6,35	3,18	25,4	63,5	6,35	10	199.008.11
8	4	32	80	8	10	199.081.11
9,52	4,76	28,57	76,2	9,52	10	199.504.11
10	5	32	80	10	10	199.100.11
12	6	35	80	12	10	199.120.11
12,7	6,35	31,75	76,2	12,7	10	199.505.11
15,88	7,94	57,15	109,5	15,88	1	199.509.11
16	8	55	110	16	1	199.160.11
19,05	9,52	57,15	109,5	19,05	1	199.511.11

TECHNICAL DETAILS:

- Premium quality HWM.
- 2 upcut spiral cutting edges [Z2].
- Excellent finish on the lower side of the work piece.
- Upward chip ejection.

APPLICATION:

- used for efficient contour cutting, end-trimming and panel sizing on solid wood, wood composites, plastic materials and laminates at high feed speed. Ensure to properly clamp workpieces. Can be used on machining centres, point-to-point boring machines, CNC routers and hand-held routers equipped with chucks or adaptors. Cost-effective solution with respect to brazed and spiral in tungsten carbide.

Solid Surface & Fiberglass Bit with DLCS Chrome Coating - LONG LIFE



151 XTREME PERFORMANCE



D mm	I mm	L mm	S mm		ORDER NO. Right-hand rotation
6	19	60	6	10	151.060.19E
6,35	25,4	63,5	6,35	10	151.064.25E
8	25	60	8	10	151.080.25E
12	25	75	12	10	151.120.25E
12,7	38	89	12,7	10	151.127.38E

TECHNICAL DETAILS:

- Premium quality HWM.
- Special positively ground cutting edge sharpening for excellent finish.

APPLICATION:

used for efficient contour cutting, end-trimming and panel sizing on glass fiber and fiberglass, phenolic and composite material.
For use on machining centres, point-to-point boring machines, CNC routers and hand-held routers equipped with chucks or adaptors.



DLCS CHROME COATING:

- Superb wear resistance
- Better chip clearance
- Superior cutting quality
- Less overheating
- More productivity



DLCS CHROME COATING
PROVIDES 3 TIMES LONGER LIFE THAN UNCOATED TOOLS!

Solid Surface & Fiberglass Bit with DLCS Chrome Coating - LONG LIFE



151 XTREME PERFORMANCE



D mm	I mm	L mm	S mm		ORDER NO. Right-hand rotation
6	19	60	6	10	151.060.19D
6,35	25,4	63,5	6,35	10	151.064.25D
8	25	60	8	10	151.080.25D
12	25	75	12	10	151.120.25D
12,7	38	89	12,7	10	151.127.38D

TECHNICAL DETAILS:

- Premium quality HWM.
- Special positively ground cutting edge sharpening for excellent finish.

APPLICATION:

used for efficient contour cutting, end-trimming and panel sizing on fiberglass, glass fiber phenolic and composite material. The 135° tooth geometry allows vertical feeding minimizing the bending of the workpiece. To be used on machining centres, point-to-point boring machines, CNC routers and hand-held routers equipped with chucks or adaptors.



DLCS CHROME COATING:

- Superb wear resistance
- Better chip clearance
- Superior cutting quality
- Less overheating
- More productivity

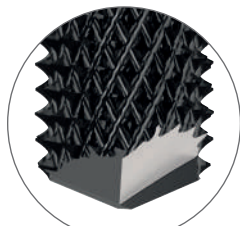

SHARPENING
135°



DLCS CHROME COATING
PROVIDES 3 TIMES LONGER LIFE THAN UNCOATED TOOLS!

DP - Router Cutters with Negative Shear Angle - LONG LIFE



40X
LONGER LIFE
THAN CARBIDE

141 (HWM TOOL BODY)



D mm	I mm	L mm	S mm	Z		ORDER NO. Right-hand rotation
6	10	60	6	1 Neg.	1	141.260.61
8	15	65	8	1 Neg.	1	141.280.61
10	15	65	10	1 Neg.	1	141.300.61
12	20	70	12	1 Neg.	1	141.320.61

TECHNICAL DETAILS:

- Special micrograin carbide formulation.
- Straight cutting edge.
- DP (H3).
- Resharpenable cutter (max 3 times).
- Feed speed on MDF 3-4 m/min for cutter Ø6 and Ø8mm and 4-5m/minute for Ø10and Ø12mm.

APPLICATION:

for boring, contour cutting and panel sizing on veneered and wood-based materials. For use on machining centers, point to point boring machines and CNC pantographs equipped with adaptors and chucks.

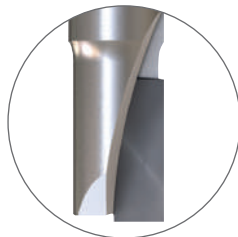

NEGATIVE CUTTING EDGE

DP - Router Cutters - LONG LIFE



40X
LONGER LIFE
THAN CARBIDE

141



D mm	I mm	L mm	S mm	Z		ORDER NO. Right-hand rotation
6	8	65	12x40	1	1	141.060.61
8	12	65	12x40	1	1	141.080.61
10*	22	75	12x40	1+1	1	141.101.61

TECHNICAL DETAILS:

- Strength steel.
- DP cutting edge (H2,5).
- HW plunging tip for diagonal plunge-cutting.
- Resharpenable cutter (max 3 times).
- Max feed speed 4 m/min.

APPLICATION:

for boring, contour cutting and panel sizing on veneered and wood-based materials. For use on machining centers, point to point boring machines and CNC pantographs equipped with adaptors and chucks.



* CONSTRUCTION Z1+1
FOR 141.101.61 ITEM



40X
LONGER LIFE
THAN CARBIDE

140

D mm	I mm	L mm	S mm	Z		ORDER NO. Right-hand rotation
10	25	75	12x40	1+1 (3 DP+1 HW)	1	140.03956
12	25	76	12x40	1+1 (3 DP+1 HW)	1	140.120.61
12	35	85	12x40	1+1 (4 DP+1 HW)	1	140.121.61
12,7	25	76	12,7x40	1+1 (3 DP+1 HW)	1	140.127.61
12,7	35	84	12,7x40	1+1 (4 DP+1 HW)	1	140.128.61
15,87	27	85	15,87x50	1+1 (3 DP+1 HW)	1	140.158.61
15,87	45	103	15,87x50	1+1 (5 DP+1 HW)	1	140.159.61
16	25	85	16x50	1+1 (3 DP+1 HW)	1	140.160.61
16	35	95	16x50	1+1 (4 DP+1 HW)	1	140.161.61
18	25	87	20x50	1+1 (3 DP+1 HW)	1	140.180.61
18	35	97	20x50	1+1 (4 DP+1 HW)	1	140.181.61
18	45	107	20x50	1+1 (5 DP+1 HW)	1	140.182.61
19,05	25	85	19,05x50	1+1 (3 DP+1 HW)	1	140.190.61
19,05	45	104	19,05x50	1+1 (5 DP+1 HW)	1	140.192.61
20	25	85	20x50	1+1 (3 DP+1 HW)	1	140.200.61
20	35	95	20x50	1+1 (4 DP+1 HW)	1	140.201.61
20	45	104	20x50	1+1 (5 DP+1 HW)	1	140.202.61
20	55	113	20x50	1+1 (6 DP+1 HW)	1	140.203.61

TECHNICAL DETAILS:

- Strength steel.
- Shear angle. - DP cutting edge (H2,5).
- HW plunging tip for diagonal plunge-cutting.
- Resharpeable (max 3 times).
- Max feed speed 5 m/min.

APPLICATION: for contour cutting and panel sizing on hard and abrasive materials such as laminates, MDF and melamine. For use on machining centers, point to point boring machines and CNC pantographs equipped with adaptors and chucks.



Results shown in this diagram are purely empirical, based merely on informative and hypothetical calculation. Each application may require different parameters in consideration of materials in use and machining conditions. CMT is not responsible for direct, indirect, incidental or consequential damages resulting from any defect, error or failure due to this diagram.

Ø10-12,7mm PLASTIC COATED CHIPBOARD

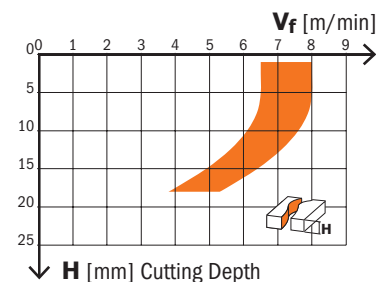

24000 RPM
Correction factor for Vr: MDF=0.8
Veneer across grain=0.7
Chipboard without coating=1.1

Ø15,87-20mm PLASTIC COATED CHIPBOARD

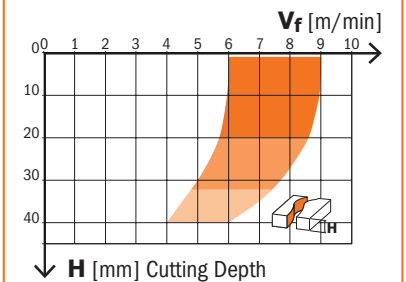

18000 RPM
Correction factor for Vr: MDF=0.8
Veneer across grain=0.7
Chipboard without coating=1.1



40X
LONGER LIFE
THAN CARBIDE

140

D mm	I mm	L mm	S mm	Z		ORDER NO. Right-hand rotation
20	25	85	20x50	1+1 (6 DP+1 HW)	1	140.720.61
20	35	95	20x50	1+1 (8 DP+1 HW)	1	140.721.61
20	45	105	20x50	1+1 (9 DP+1 HW)	1	140.722.61

TECHNICAL DETAILS:

- Strength steel.
- Diamond cutting edges featuring 45° shear angle (H4).
- HW plunging tip for plunge cutting.
- Resharpenable cutters (max 8-9 times).
- Max feed speed 5 m/min.

APPLICATION:

for contour cutting and panel sizing on hard and abrasive materials such as laminates, MDF and melamine. For use on machining centers, point to point boring machines and CNC pantographs equipped with adaptors and chucks.

Ø20mm PLASTIC COATED CHIPBOARD

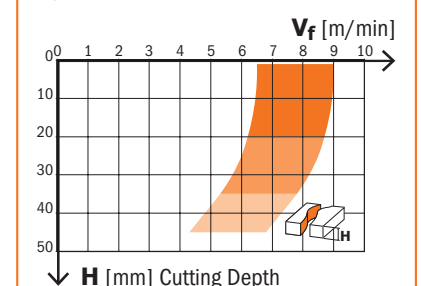

18000 RPM
Correction factor for Vr: MDF=0.8
Veneer across grain=0.7
Chipboard without coating=1.1

DP - Router Cutters with 45° Shear Angle - LONG LIFE



DP - Router Cutters with Shear Angle - LONG LIFE



40X
LONGER LIFE
THAN CARBIDE

142



D mm	I mm	L mm	S mm	Z		ORDER NO. Right-hand rotation
20	25	85	20x50	2+2 (6 DP+1 HW)	1	142.200.61
20	35	95	20x50	2+2 (8 DP+1 HW)	1	142.201.61
20	45	104	20x50	2+2 (10 DP+1 HW)	1	142.202.61
20	55	113	20x50	2+2 (12 DP+1 HW)	1	142.203.61
25	27	90	25x55	2+2 (6 DP+1 HW)	1	142.250.61
25	36	100	25x55	2+2 (8 DP+1 HW)	1	142.251.61
25	45	110	25x55	2+2 (10 DP+1 HW)	1	142.252.61
25	55	120	25x55	2+2 (12 DP+1 HW)	1	142.253.61

TECHNICAL DETAILS:

- Strength steel.
- DP cutting edge (H2,5").
- HW plunging tip for diagonal plunge-cutting (Z-axis tool entrance).
- Resharpenable cutter (max 3 times).
- Feed speed: max 10m/min

APPLICATION:

for use on CNC routers for jointing, rabbeting, grooving, on laminates, MDF, HPL, veneer and melamine-faced panels.

Ø20-25mm PLASTIC COATED CHIPBOARD

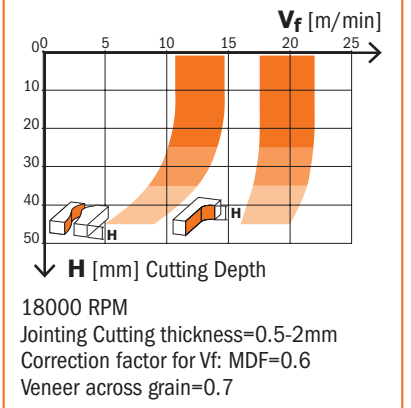

DP - Router Cutters with 20° Shear Angle - LONG LIFE



40X
LONGER LIFE
THAN CARBIDE

142



D mm	I mm	L mm	S mm	Z		ORDER NO. Right-hand rotation
20	25	85	20x45	2+2 (8 DP+1 HW)	1	142.720.61
20	30	90	20x45	2+2 (10 DP+1 HW)	1	142.721.61
20	35	95	20x45	2+2 (12 DP+1 HW)	1	142.722.61
20	40	100	20x45	2+2 (14 DP+1 HW)	1	142.723.61
20	45	105	20x45	2+2 (16 DP+1 HW)	1	142.724.61
20	50	110	20x45	2+2 (18 DP+1 HW)	1	142.725.61
20	55	115	20x45	2+2 (20 DP+1 HW)	1	142.726.61

TECHNICAL DETAILS:

- Strength steel.
- Diamond cutting edges featuring 20° shear angle (H4).
- HW plunging tip for diagonal plunge-cutting (Z-axis tool entrance).
- Resharpenable cutters (max 8-10 times).
- Max feed speed 20 m/min.

APPLICATION:

for use on CNC routers for jointing, rabbeting, grooving, on laminates, MDF, HPL, veneer and melamine-faced panels.

Ø20-25mm PLASTIC COATED CHIPBOARD

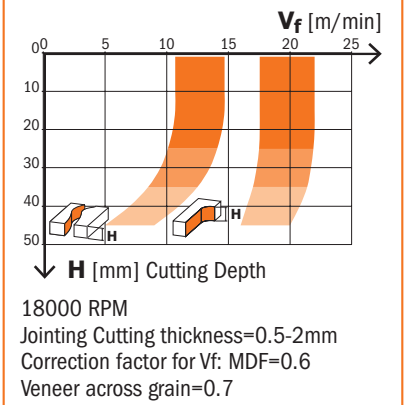

Results shown in this diagram are purely empirical, based merely on informative and hypothetical calculation. Each application may require different parameters in consideration of materials in use and machining conditions. CMT is not responsible for direct, indirect, incidental or consequential damages resulting from any defect, error or failure due to this diagram.

DP - Router Cutters with Shear Angle for Nesting - LONG LIFE (DENSIMET® Tungsten Heavy Metal Alloys)



40X
LONGER LIFE
THAN CARBIDE

143



D mm	I mm	L mm	S mm	Z		ORDER NO. Right-hand rotation
12	25	75	12x40	3 (9 DP)	1	143.120.61
12	31	79	12x40	3 (10 DP)	1	143.121.61

TECHNICAL DETAILS:

- DENSIMET® tungsten heavy metal alloys for low-vibration.
- DP cutting edge (H3).
- Resharpenable cutter (max 6 times).
- Max feed speed 25 m/min.

APPLICATION:

for use on CNC routers for jointing, rabbeting, grooving, on laminates, MDF, HPL, veneer and melamine-faced panels. High performance pre-finishing and finish-routing.

Ø12mm PLASTIC COATED CHIPBOARD

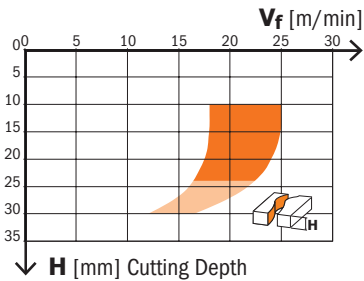

24000 RPM
Correction factor for Vf: MDF=0.8
Pre-finishing MDF=1.2
Uncoated Chipboard=1.1
Veneer across grain=0.7

DP - Spiral Router Cutters with Shear Angle - LONG LIFE



40X
LONGER LIFE
THAN CARBIDE

143



D mm	I mm	L mm	S mm	Z		ORDER NO. Right-hand rotation	
18	25	82	20x50	3 (10 DP+1 HW)	1	143.180.61	
18	30	87	20x50	3 (13 DP+1 HW)	1	143.181.61	
18	35	92	20x50	3 (15 DP+1 HW)	1	143.182.61	
20	25	82	20x50	3 (10 DP+1 HW)	1	143.200.61	
20	30	85	20x50	3 (13 DP+1 HW)	1	143.201.61	
20	35	92,5	20x50	3 (15 DP+1 HW)	1	143.202.61	
20	40	97	20x50	3 (18 DP+1 HW)	1	143.203.61	
20	45	102	20x50	3 (21 DP+1 HW)	1	143.204.61	
20	50	106,5	20x50	3 (24 DP+1 HW)	1	143.205.61	
20	55	111	20x50	3 (27 DP+1 HW)	1	143.206.61	
20	60	116,5	20x50	3 (30 DP+1 HW)	1	143.207.61	
20	65	121,5	20x50	3 (31 DP+1 HW)	1	143.208.61	
22	30	92	25x50	3 (13 DP+1 HW)	1	143.220.61	
<input type="checkbox"/>	22	35	97	25x50	3 (15 DP+1 HW)	1	143.221.61
<input type="checkbox"/>	22	40	102	25x50	3 (18 DP+1 HW)	1	143.222.61
<input type="checkbox"/>	22	45	107	25x50	3 (21 DP+1 HW)	1	143.223.61
<input type="checkbox"/>	22	50	112	25x50	3 (24 DP+1 HW)	1	143.224.61
<input type="checkbox"/>	22	55	117	25x50	3 (27 DP+1 HW)	1	143.225.61
<input type="checkbox"/>	22	60	122	25x50	3 (30 DP+1 HW)	1	143.226.61
<input type="checkbox"/>	22	65	127	25x50	3 (31 DP+1 HW)	1	143.227.61
<input type="checkbox"/>	22	70	132	25x50	3 (36 DP+1 HW)	1	143.228.61

On request

Ø18-20mm PLASTIC COATED CHIPBOARD

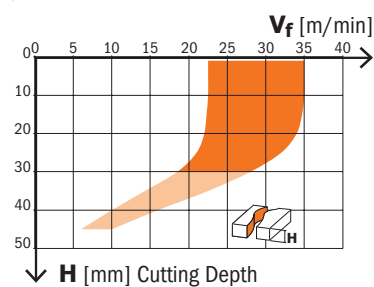

24000 RPM
Correction factor for Vf: MDF=0.8
Melamine=0.8

Ø20-22mm PLASTIC COATED CHIPBOARD

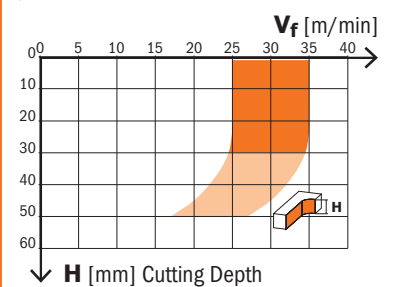

24000 RPM
Jointing Cutting thickness=0.5-6mm
Correction factor for Vf: MDF=0.9
Melamine=0.8
Veneer across grain=0.8

TECHNICAL DETAILS:

- Strength steel.
- DP cutting edge (H4).
- HW plunging tip for diagonal plunge-cutting (Z-axis tool entrance).
- Resharpenable cutter (max 8-10 times).

APPLICATION:

for use on CNC routers for jointing, rabbeting, grooving, on laminates, MDF, HPL, veneer and melamine-faced panels. High performance pre-finishing and finish-routing.



Results shown in this diagram are purely empirical, based merely on informative and hypothetical calculation. Each application may require different parameters in consideration of materials in use and machining conditions. CMT is not responsible for direct, indirect, incidental or consequential damages resulting from any defect, error or failure due to this diagram.

DP - Router Cutters with 40° Shear Angle - LONG LIFE

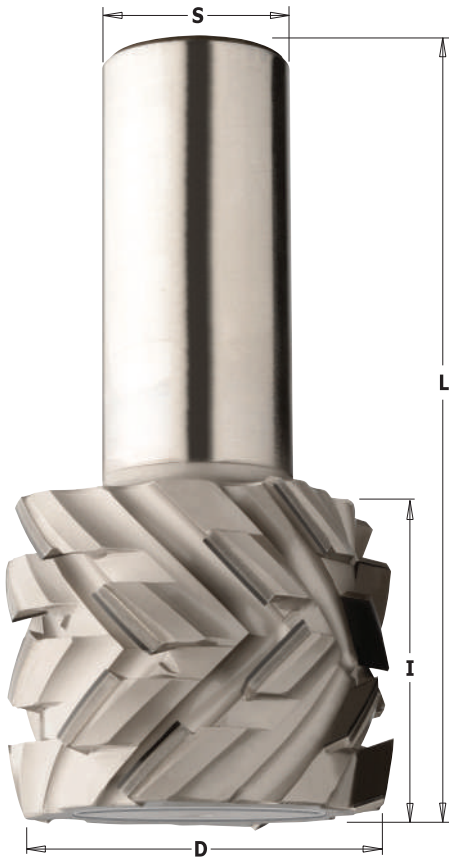

145

D mm	I mm	L mm	S mm	Z		ORDER NO. Right-hand rotation
50	23	80	25x55	3+3 (9 DP)	1	145.501.61
50	23	80	25x55	4+4 (12 DP)	1	145.511.61
50	28	85	25x55	3+3 (12 DP)	1	145.502.61
50	28	85	25x55	4+4 (16 DP)	1	145.512.61
50	38	95	25x55	3+3 (18 DP)	1	145.503.61
50	38	95	25x55	4+4 (24 DP)	1	145.513.61

On request

TECHNICAL DETAILS:

- Strength steel.
- "H4" diamond cutting edges featuring 40° shear angle.
- Resharpenable cutters (max 10 times).
- Maximum feed speed 30m/minute.

APPLICATION:

used on all CNC routers for jointing, rabbeting, grooving, copying and dividing raw material, melamine, laminated, MDF, HPL and veneered panels. High performance routing.



Straight Bits for Industrial Nesting Application DLCS Chrome Coating - LONG LIFE SHARPENING



8/912



D mm	I mm	L mm		ORDER NO. S=Ø10mm	ORDER NO. S=Ø12mm	ORDER NO. S=Ø12,7mm
6	21	73	10		912.561.11	
6	26	73	10		912.560.11	
6,35	26	73	10			812.564.11
8	21	73	10		912.582.11	
8	28,7	76	10		912.581.11	
8	28,7	76	10			812.581.11
8	32	76	10		912.583.11	
10	21	75	10	912.610.11		
10	32	75	10	912.611.11		

TECHNICAL DETAILS:

- Premium quality HWM.
- Special positively ground cutting edge sharpening for excellent finish.



- ### DLCS CHROME COATING:
- Superb wear resistance.
 - Better chip clearance.
 - Superior cutting quality.
 - Less overheating.
 - More productivity.

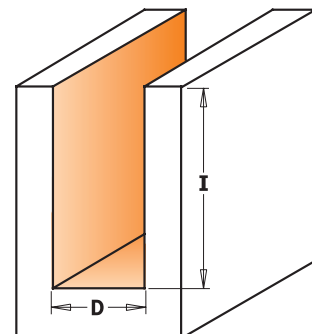

Drawing is 1:1 scale



DLCS CHROME COATING
PROVIDES 3 TIMES LONGER LIFE THAN UNCOATED TOOLS!



174



D mm	I mm	L mm	S mm		ORDER NO. Right-hand rotation
3	10	55	8	10	174.030.11
4	10	55	8	10	174.040.11
5	12	55	8	10	174.050.11
6	14	55	8	10	174.060.11
7	20	55	8	10	174.070.11

TECHNICAL DETAILS:

- Premium quality HWM.
- 2 radial relief cutting edges [Z2].
- 1 HW [Z1] plunge cutting edge.

Router Cutters

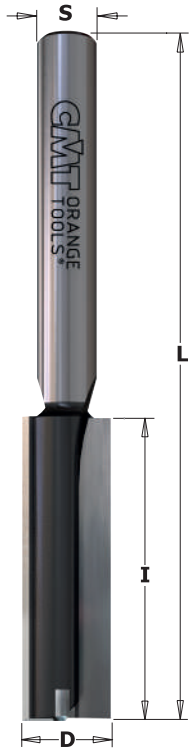

174



D mm	I mm	L mm	S mm		ORDER NO. Right-hand rotation
8	20	55	8	10	174.080.11
8	30	70	8	10	174.081.11
8	40	90	8	10	174.082.11
9	20	55	8	10	174.090.11
10	20	60	8	10	174.100.11
10	30	70	8	10	174.102.11
10	40	90	8	10	174.101.11
11	20	60	8	10	174.110.11
12	20	60	8	10	174.120.11
12	30	70	8	10	174.122.11
12	40	90	8	10	174.121.11
13	20	60	8	10	174.130.11
14	20	60	8	10	174.140.11
14	30	70	8	10	174.142.11
14	40	90	8	10	174.141.11
15	20	60	8	10	174.150.11
16	20	70	8	10	174.160.11
16	30	70	8	10	174.162.11
16	40	90	8	10	174.161.11
18	20	70	8	10	174.180.11
18	30	70	8	10	174.181.11
18	40	80	8	10	174.182.11
19	20	70	8	10	174.190.11
20	20	70	8	10	174.200.11
20	30	70	8	10	174.201.11
20	40	90	8	10	174.202.11
22	20	70	8	10	174.220.11
22	30	70	8	10	174.221.11
22	40	90	8	10	174.222.11
23,5	20	70	8	10	174.235.11
24	20	70	8	10	174.240.11
24	30	70	8	10	174.241.11
24	40	90	8	10	174.242.11
25	20	70	8	10	174.250.11
26	20	70	8	10	174.260.11
26	30	70	8	10	174.261.11
28	20	70	8	10	174.280.11
28	30	70	8	10	174.281.11
29	20	70	8	10	174.290.11
30	20	70	8	10	174.300.11
32	20	70	8	10	174.320.11



TECHNICAL DETAILS:

- Strength steel.
- 2 precision ground HW cutting edges and 1 HW plunge centre tip [Z2+1].

APPLICATION:

used for drilling, grooving or jointing on solid wood and wood composites. Can be used on machining centres, CNC routers and hand-held routers equipped with chucks or adaptors.

Solid Carbide Router Cutters

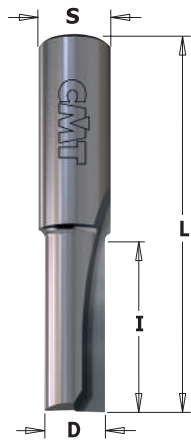

112



D mm	I mm	L mm	S mm		ORDER NO. Right-hand rotation
3	10	48	9,5	50	112.030.11
4	10	48	9,5	50	112.040.11
5	12	48	9,5	50	112.050.11
6	14	41	9,5	50	112.060.11
7	16	43	9,5	50	112.070.11
8	18	48	9,5	50	112.080.11
8	30	60	9,5	50	112.081.11
9	20	55	9,5	50	112.090.11

Router Cutters



112



D mm	I mm	L mm	S mm		ORDER NO. Right-hand rotation
10	22	52	9,5	50	112.100.11
10	35	65	9,5	50	112.101.11
11	26	52	9,5	10	112.110.11
12	26	52	9,5	10	112.120.11

113

D mm	I mm	L mm	S mm		ORDER NO. Right-hand rotation
12	26	52	12	10	113.120.11
12	40	70	12	10	113.121.11
13	26	52	12	10	113.130.11
14	28	56	12	10	113.140.11
14	40	72	12	10	113.141.11
15	32	60	12	10	113.150.11
16	32	60	12	10	113.160.11
16	40	72	12	10	113.161.11
18	35	64	12	10	113.180.11
19	38	68	12	1	113.190.11
20	38	68	12	1	113.200.11
22	40	72	12	1	113.220.11
24	40	72	12	1	113.240.11
25	40	72	12	1	113.250.11
26	42	74	12	1	113.260.11
28	42	74	12	1	113.280.11
30	42	74	12	1	113.300.11



TECHNICAL DETAILS:

- Strength steel.
- 2 precision ground HW cutting edges
- 1 HW plunge centre tip [Z2+1].

APPLICATION:

used for plunging cutting and grooving on solid wood and wood derivatives as well as laminates and plastic materials. For use on CNC machining centres, CNC routers, hand-held routers and point-to-point machines equipped with chucks or adaptors.

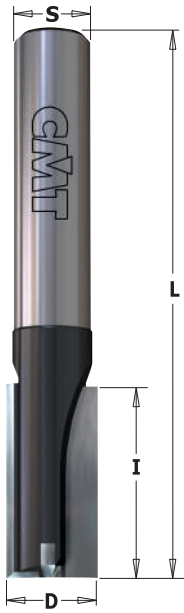

TECHNICAL DETAILS:

- Premium quality HWM.
- 2 radial relief cutting edges [Z2].
- 1 HW [Z1] plunge centre tip.



175



D mm	I mm	L mm	S mm		ORDER NO. Right-hand rotation
• 4	10	65	10	50	175.040.11
• 5	12	65	10	50	175.050.11
• 6	14	65	10	50	175.060.11
• 7	16	65	10	50	175.070.11
8	20	65	10	50	175.080.11
10	25	70	10	50	175.100.11
12	25	70	10	10	175.120.11
14	25	70	10	10	175.140.11
15	25	70	10	10	175.150.11
16	25	70	10	10	175.160.11
18	25	70	10	10	175.180.11
20	25	70	10	10	175.200.11
22	25	70	10	10	175.220.11
24	25	70	10	10	175.240.11
25	25	70	10	10	175.250.11
26	25	70	10	10	175.260.11
30	25	70	10	10	175.300.11
35	25	70	10	10	175.350.11

• HWM

176



D mm	I mm	L mm	S mm		ORDER NO. Right-hand rotation
10	40	87	10	10	176.100.11
12	40	87	10	10	176.120.11
14	40	87	10	10	176.140.11
15	40	87	10	10	176.150.11
16	40	87	10	10	176.160.11
18	40	87	10	10	176.180.11
20	40	87	10	10	176.200.11

APPLICATION:

used for plunging cutting and grooving on solid wood and wood derivatives as well as laminates and plastic materials. For use on CNC machining centres, CNC routers, hand-held routers and point-to-point machines equipped with chucks or adaptors.

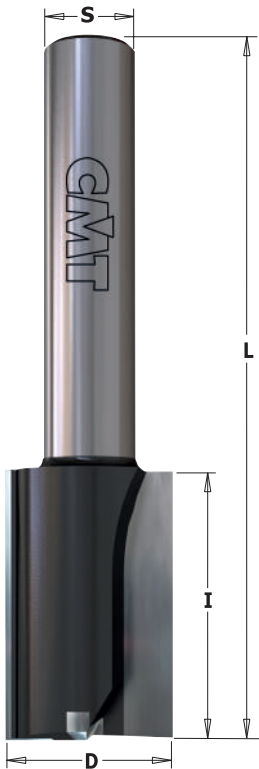

177



D mm	I mm	L mm	S mm		ORDER NO. Right-hand rotation
10	35	90	12	10	177.100.11
12	35	90	12	10	177.120.11
12	50	100	12	10	177.121.11
14	35	90	12	10	177.140.11
16	35	90	12	10	177.160.11
16	60	110	12	10	177.161.11
18	35	90	12	10	177.180.11
18	60	110	12	10	177.181.11
20	35	90	12	10	177.200.11
22	35	90	12	10	177.220.11
24	35	90	12	10	177.240.11
25	35	90	12	10	177.250.11
26	35	90	12	10	177.260.11
28	35	90	12	10	177.280.11
30	35	90	12	10	177.300.11
35	35	90	12	10	177.350.11



TECHNICAL DETAILS:

- Strength steel.
- 2 precision ground HW cutting edges
- 1 HW plunge centre tip [Z2+1].

APPLICATION:

used for plunge cutting and grooving on solid wood, wood derivatives as well as laminates and plastic materials. For use on CNC machining centres, CNC routers and hand-held routers.

XTreme Plunge CNC Cutters with Insert Knives



653 XTREME



D mm	I mm	L mm	S mm	Box	ORDER NO.	Spare parts	
40	29,5	100	20	10	653.001.11	790.295.12	790.120.00

Spare parts: **990.075.00** M4x6mm TORX® screw
991.061.00 T15 TORX® key
990.036.00 M8x25mm TE screw
990.020.00 Hex nut for threaded arbors M8

TECHNICAL DETAILS:

- Strength steel.
- 4 cutting edges [Z2+2]

APPLICATION:

the new CNC cutter is designed with 2 plunging knives and two-sided knives fixed by special TORX® screws. It is ideal for direct plunge into the material and fast removal over a large surface area leaving an improved finish at the bottom of the cut. For cutting soft/hard wood, chipboard, melamine, MDF. For use on pantograph CNC machines.

SAFETY TIPS

The **TW-006** Torque Screwdriver is recommended for the proper fastening of screws (see page 413).

CORRECT KNIFE POSITIONING

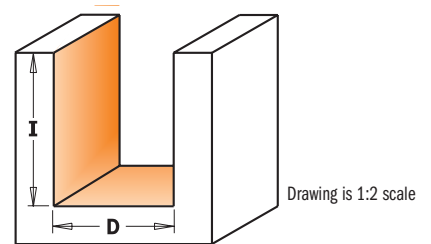
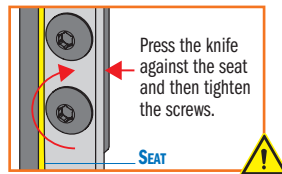

Straight Router Cutters with Insert Knives



653



D mm	I mm	L mm	S mm	Box	ORDER NO.	Spare parts	
16	28,3	92	20	10	653.661.11	790.283.12	790.075.00
16	48,3	111,5	20	10	653.662.11	790.483.12	790.075.00
18	48,3	111,5	20	10	653.681.11	790.483.12	790.075.00
20	48,3	111,5	20	10	653.701.11	790.483.12	790.075.00

Spare parts: **990.072.00** M3,5x3,5mm TORX® screw
990.074.00 M4x3,5mm TORX® screw
990.075.00 M4x6mm TORX® screw
991.061.00 T15 TORX® key

TECHNICAL DETAILS:

- Strength steel.
- 2 cutting edges [Z1+1].

APPLICATION:

straight router bits with on replaceable plunging knife and side knife fixed by a special TORX® screw. The tool bodies are precisely balanced. For finishing, routing, plunging and grooving on board materials (laminated chipboards and MDF) and hardwood. For use on portable routers or CNC machining centres.

CORRECT KNIFE POSITIONING

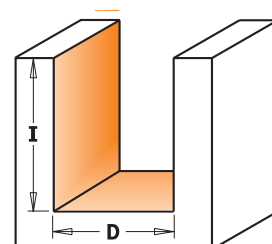
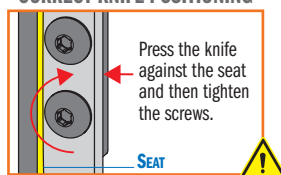

SAFETY TIPS

The **TW-006** Torque Screwdriver is recommended for the proper fastening of screws (see page 413).

Spoilboard Surfacing Router Cutters with Insert Knives

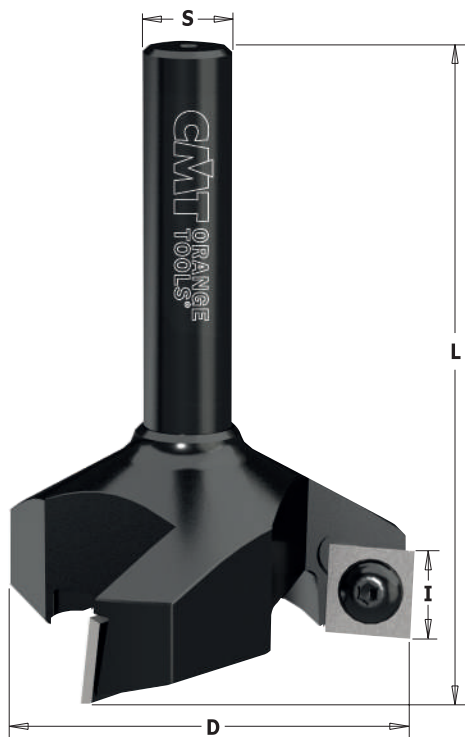

663.0



D mm	I mm	L mm	Z	S mm	Box	ORDER NO. Right-hand rotation	Spare parts	
35	10,5	60	3	8x38	10	663.007.11	790.105.03*	990.078.00
38	12	60	3	12x38	10	663.005.11	790.120.03*	990.075.00
38	12	60	3	12,7x38	10	663.015.11	790.120.03*	990.075.00
60	12	80	3	12x50	10	663.004.11	790.120.03*	990.075.00
60	12	80	3	12,7x50	10	663.014.11	790.120.03*	990.075.00
80	12	90	3	20x60	10	663.003.11	790.120.03*	990.075.00
100	12	90	4	20x50	1	663.006.11	790.120.03*	990.075.00

Spare parts: **991.061.00** T15 TORX® key
990.036.00 M8x25mm TE screw (for 663.003.11 and 663.006.11)
990.020.00 Hex nut for threaded arbors M8 (for 663.003.11 and 663.006.11)

*Minimum 10 pieces or multiple

TECHNICAL DETAILS:

- Strength steel.
- 3 cutting edges [Z3].
- 4 cutting edges [Z4].

APPLICATION:

the new router bit for CNC routers is ideal for fast removal of material over a large surface area leaving an improved finish at the bottom of the cut. Used on soft and hardwood, particle board and MDF. The cutter uses 4-sided inserts in super micrograin carbide.

A cost effective solution compared to brazed router bits and solid carbide spiral bits.

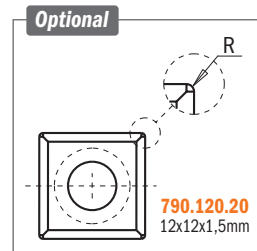

SAFETY TIPS

The **TW-006** Torque Screwdriver is recommended for the proper fastening of screws (see page 413).

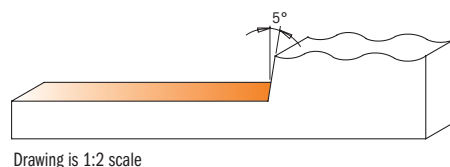
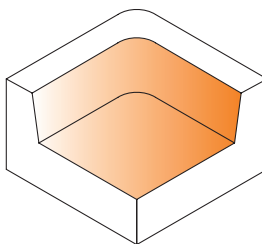

Spoilboard Surfacing Router Cutters

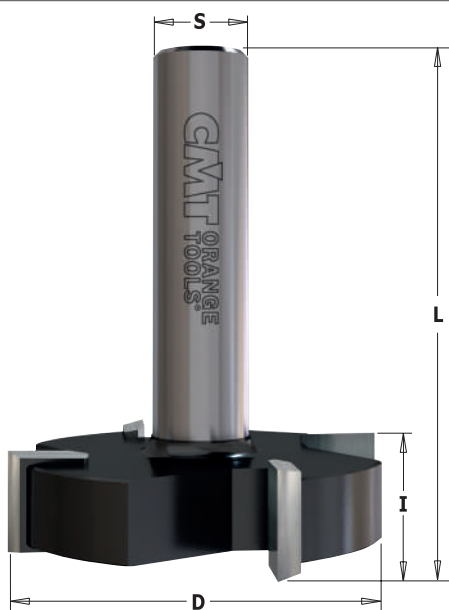

178



D mm	I mm	L mm	Z	S mm	Box	ORDER NO. Right-hand rotation
25,4	6,35	41	3	6,35	1	178.701.11
34,9	9,5	57	3	8	1	178.702.11
50,8	12,7	63,5	4	12	1	178.703.11
50,8	12,7	63,5	4	12,7	1	178.704.11

TECHNICAL DETAILS:

- Strength steel.
- 3 cutting edge [Z3].
- 4 cutting edge [Z4].

APPLICATION:

The new router bit for CNC routers is ideal for fast removal of material over a large surface area leaving an improved finish at the bottom of the cut. Used on soft and hardwood, particle board and MDF.

The cutter uses 4-sided inserts in super micrograin carbide.

A cost effective solution compared to brazed router bits and solid carbide spiral bits.

XTreme Spoilboard Surfacing Router Cutter with Insert Knives

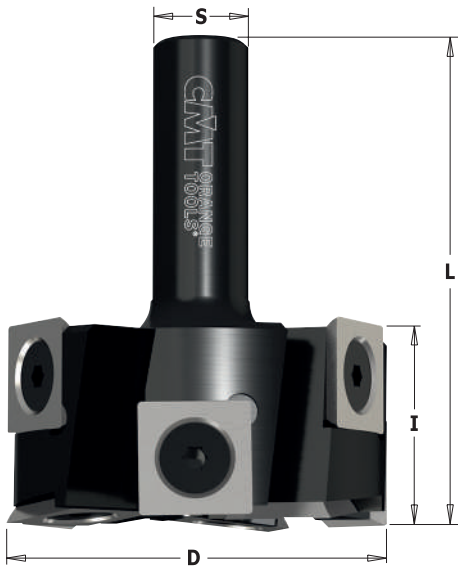

663.5 XTREME



D mm	I mm	L mm	S mm	Box	ORDER NO. Right-hand rotation	Spare parts	
50,8	25,4	63,5	12	10	663.502.11		790.140.20*
50,8	25,4	63,5	12,7	10	663.501.11		990.080.00

TECHNICAL DETAILS:

- Strength steel.
- 6 + 3 cutting edges [Z6+V3]

APPLICATION: this new router bit designed for CNC router machines and stationary router machine work centers are ideal for rabbeting joints and for quick chip removal on large surface areas and leaves a good finish at the bottom of the cut. Ideal for soft and hard wood, particle board and MDF. This bit is equipped with 4 sided insert knives in super micrograin carbide – an economical solution for brazed and solid carbide spiral bits.

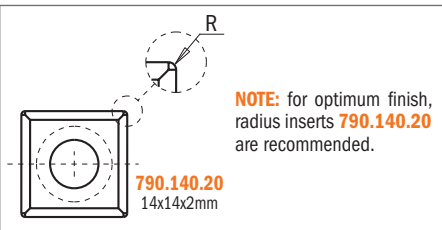
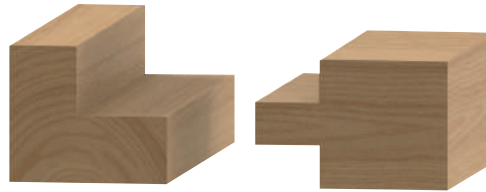

SAFETY TIPS

The **TW-006** Torque Screwdriver is recommended for the proper fastening of screws (see page 413).

*Minimum 10 pieces or multiple

Universal Profile Cutter for CNC Machines



KNIVES NOT INCLUDED

663.301



D mm	I mm	L mm	S mm	Box	ORDER NO. Right-hand rotation
65	40-50	93	20	1	663.301.11

Spare parts: **692.999.01** 38x15x16mm wedge for cutter
990.064.00 M8x16mm STEI screw
991.064.00 Hex key 4mm

TECHNICAL DETAILS:

- Strength steel.
- 2 cutting edges [Z2] for knives 40x4mm and 50x4mm.

APPLICATION: for universal profiling of solid wood on CNC router machines. For cutting width 40mm and 50mm (serie **690**). Profile knives may only be ordered and used in pairs.

USEFUL TIPS: for enhanced safety, when using 50mm knives, it is recommended to carry out the cut in several passes.

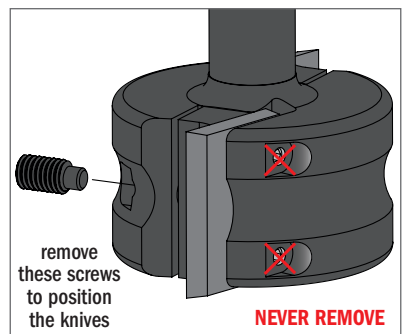

SAFETY TIPS

The **TW-006** Torque Screwdriver is recommended for the proper fastening of screws (see page 413).

Suggested MAX RPM 12.000

TO BE USED WITH SP KNIVES SERIES 690 (SEE PAGE 154~166)

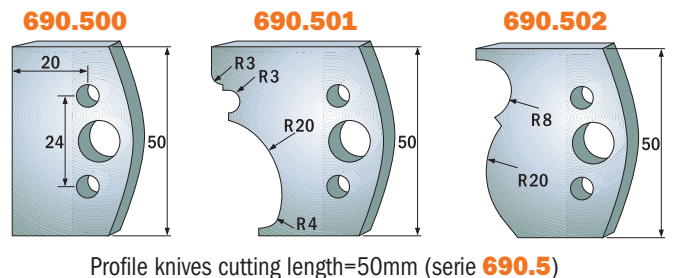
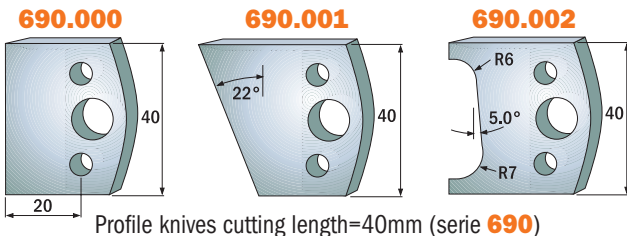

Adjustable Chamfering CNC Cutter

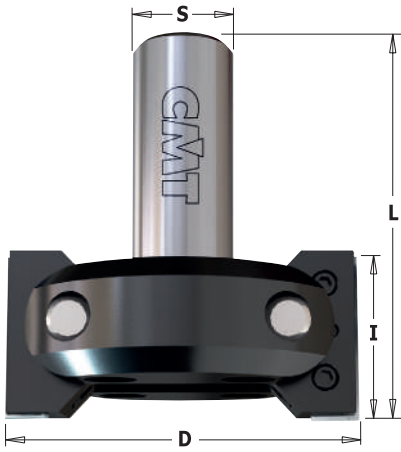

663.201



D mm	D_Max 45° mm	I mm	A	L mm	S mm	Box	ORDER NO.
85	102	39,5	0°-45° - 0°+90°	92	20	1	Right-hand rotation 663.201.11

- Spare parts:**
- 790.395.12** 39,5x12x1,5mm knife (Minimum 10 pieces or multiple)
 - 663.999.01** 38x6x12mm wedge
 - 990.087.00** M6x8mm STEI screw (4x2mm threaded pin)
 - 991.067.00** 3mm hex key
 - 663.999.02** Kit with 2 wedges and 1 screw for blocking rotation
 - 990.099.00** M8x25mm TCEI screw
 - 990.023.00** M8 (4mm) nut
 - 991.081.00** 4mm "T" hex key

SAFETY TIPS

The **TW-006** Torque Screwdriver is recommended for the proper fastening of screws (see page 413).

TECHNICAL DETAILS:

- Tool body in steel.
- 2 reversible HWM knives 39,5x12x1,5mm [Z2].
- Peripheral cutting on both sides.
- Adjustable swivelling blade (Rotates at 7,5° intervals; Precision = 7,5°).
- Swivelling range 0-45° towards top, and 0-90° towards bottom.

APPLICATION:

for jointing, rebating and chamfering of solid wood and wooden boards. Suitable for CNC router machines and stationary router machine with manual or mechanical feed. Never modify the chamfering angle whilst changing the knives. RH rotation.

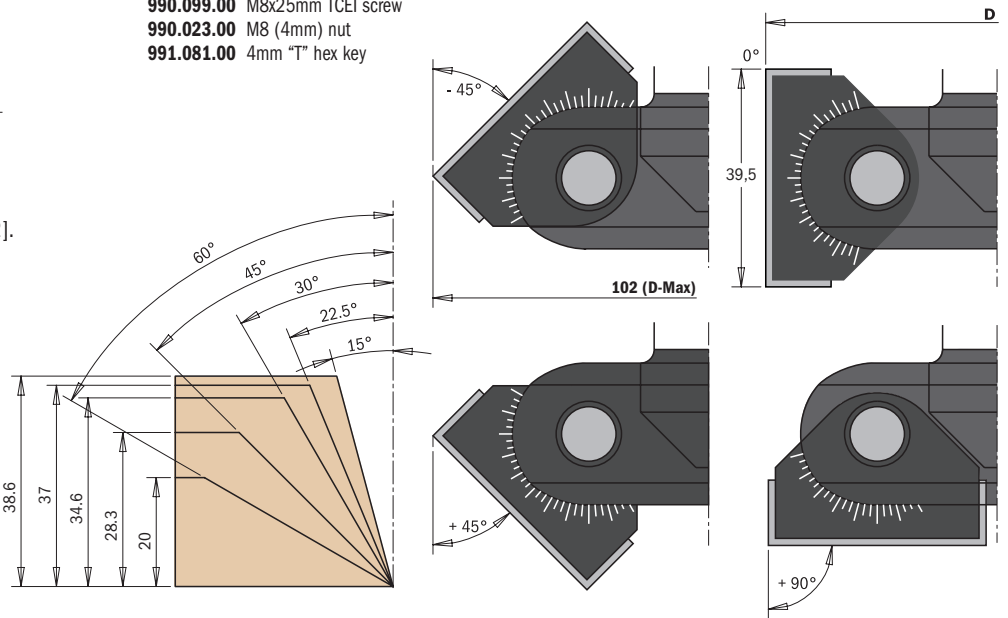

V-Groove - Folding - Signmaking CNC Router Cutters with Insert Knives



663.1



D mm	I mm	L mm	A	S mm	Z	Box	ORDER NO.
34	40	115	45°	20	1	10	Right-hand rotation 663.103.11
44	38	115	60°	20	1	5	663.102.11
52	25	102	91°	20	1	1	663.101.11
60	21	95	110°	20	1	1	663.110.11
87,5	24	95	120°	20	2	1	663.120.11
91	20	95	130°	20	2	1	663.130.11
96,5	12,4	95	150°	20	2	1	663.150.11

Spare parts

	790.580.01*
	790.580.01*
	790.360.01*
	790.360.01*
	790.496.01*
	790.496.01*
	790.496.01*

- Spare parts:**
- 990.073.00** M3,5x5x7,2mm TORX® T15 screw (for 790.580.01 and 790.360.01)
 - 990.075.00** M4x6x8,2mm TORX® T15 screw (for 790.496.01)
 - 991.061.00** T15 TORX® key
 - 990.036.00** M8x25mm TE screw
 - 990.020.00** Hex nut for threaded arbors M8

Optional: 5790.360.03* 36x12x1,5mm HW-SMG replaceable knife (4 cutting edges 35°)

*Minimum 10 pieces or multiple

CORRECT KNIFE POSITIONING

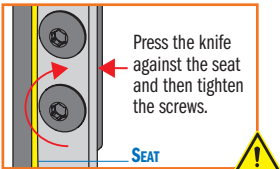

SAFETY TIPS

The **TW-006** Torque Screwdriver is recommended for the proper fastening of screws (see page 413).

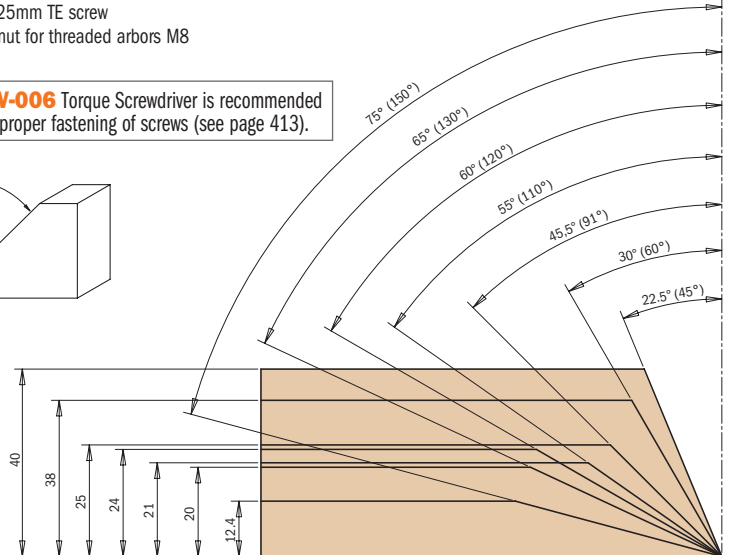
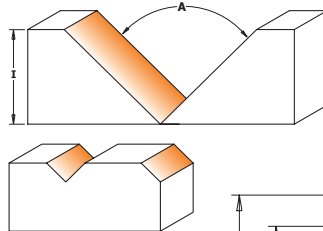

TECHNICAL DETAILS:

- Strength steel.
- 1 cutting edge [Z1]
- 2 cutting edges [Z2]

APPLICATION:

this innovative CNC router bit offers you an endless range of possibilities for V-Groove, miter folds, signmaking, lettering and chamfer edges. The tool mounts a high grade HWM reversible knife ideal for general purpose, chipboard and plywood, but knives with increased hardness are available for laminated and MDF material.



300.023.01 BASIC CNC KIT

DESCRIPTION	Q.TY	ORDER NO.
CHUCK -XTREME- HSK-63F (H73) "ER32" PRECISION COLLET RH	1	183.300.01
C-SPANNER FOR "ER32" PRECISION COLLET	1	991.183.00
PRECISION COLLET DIN6499 "ER32" (33x40mm) D=12mm	1	184.120.00
PRECISION COLLET DIN6499 "ER32" (33x40mm) D=20mm	1	184.200.00
STRAIGHT ROUTER CUTTER WITH INSERT KNIVES HW Z1+1 S=20 D=18x48.3mm RH	1	653.681.11
HWM REVERSIBLE KNIVES STD (4/35°) 48.3x12x1.5mm RH	10	790.483.12
HWM REVERSIBLE KNIVES STD (2/35°) 7.5x12x1.5mm	10	790.075.00
KEY TORX® T15	1	991.061.00
SOLID CARBIDE UPCUT SPIRAL BITS Z3 POS. HWM D=12x42x90mm RH	1	193.121.11
2 FLUTE DOWEL DRILL HW S=10x30mm D=5x35x70mm RH	2	311.050.11
2 FLUTE DOWEL DRILL HW S=10x30mm D=5x35x70mm LH	2	311.050.12
2 FLUTE DOWEL DRILL HW S=10x30mm D=8x35x70mm RH	4	311.080.11
2 FLUTE DOWEL DRILL HW S=10x30mm D=8x35x70mm LH	4	311.080.12
HINGE BORING BITS HW Z2+2 S=10x26mm D=15x70mm RH	1	369.150.11
HINGE BORING BITS HW Z2+2 S=10x26mm D=35x70mm RH	1	369.350.11

At request available with ER40



300.025.01 EXPERT FOR "NESTING" CNC KIT

DESCRIPTION	Q.TY	ORDER NO.
CHUCK -XTREME- HSK-63F (H73) "ER32" PRECISION COLLET RH	2	183.300.01
C-SPANNER FOR "ER32" PRECISION COLLET	1	991.183.00
PRECISION COLLET DIN6499 "ER32" (33x40mm) D=12mm	1	184.120.00
PRECISION COLLET DIN6499 "ER32" (33x40mm) D=20mm	1	184.200.00
KINETIC DUST EXTRACTOR FOR CHUCK WITH "ER32" D=100mm RH	1	992.101.ER32
C-SPANNER 95-100mm FOR KINETIC "ER32"/"ER40"	1	991.284.00
SPOILBOARD SURFACING ROUTER CUTTER W/INSERT KNIVES HW Z3 S=20x50mm D=80x12x90mm	1	663.003.11
HWM REVERSIBLE KNIVES STD (4/35°) 12x12x1.5mm	10	790.120.03
KEY TORX® T15	1	991.061.00
ROUTER CUTTERS WITH SHEAR ANGLE FOR NESTING Z3 9DP S=12mm D=12x25x70mm RH	1	143.120.61
2 FLUTE DOWEL DRILL HW S=10x30mm D=5x35x70mm RH	2	311.050.11
2 FLUTE DOWEL DRILL HW S=10x30mm D=5x35x70mm LH	2	311.050.12
2 FLUTE DOWEL DRILL HW S=10x30mm D=8x35x70mm RH	4	311.080.11
2 FLUTE DOWEL DRILL HW S=10x30mm D=8x35x70mm LH	4	311.080.12
HINGE BORING BITS HW Z2+2 S=10x26mm D=15x70mm RH	1	369.150.11
HINGE BORING BITS HW Z2+2 S=10x26mm D=35x70mm RH	1	369.350.11



Includes:

At request available with ER40



616.000.01

This unique system includes a tool body with 22 profile knives designed for multiple applications on your CNC routers. Ideal for MDF, laminates, veneers, plastic, wood and solid surface materials.

TECHNICAL DETAILS:

Knives 20x20x2mm.

We recommend re-sharpening the knives on profile cutting edge.

SAFETY TIPS



The **TW-006** Torque Screwdriver is recommended for the proper fastening of screws (see page 413).

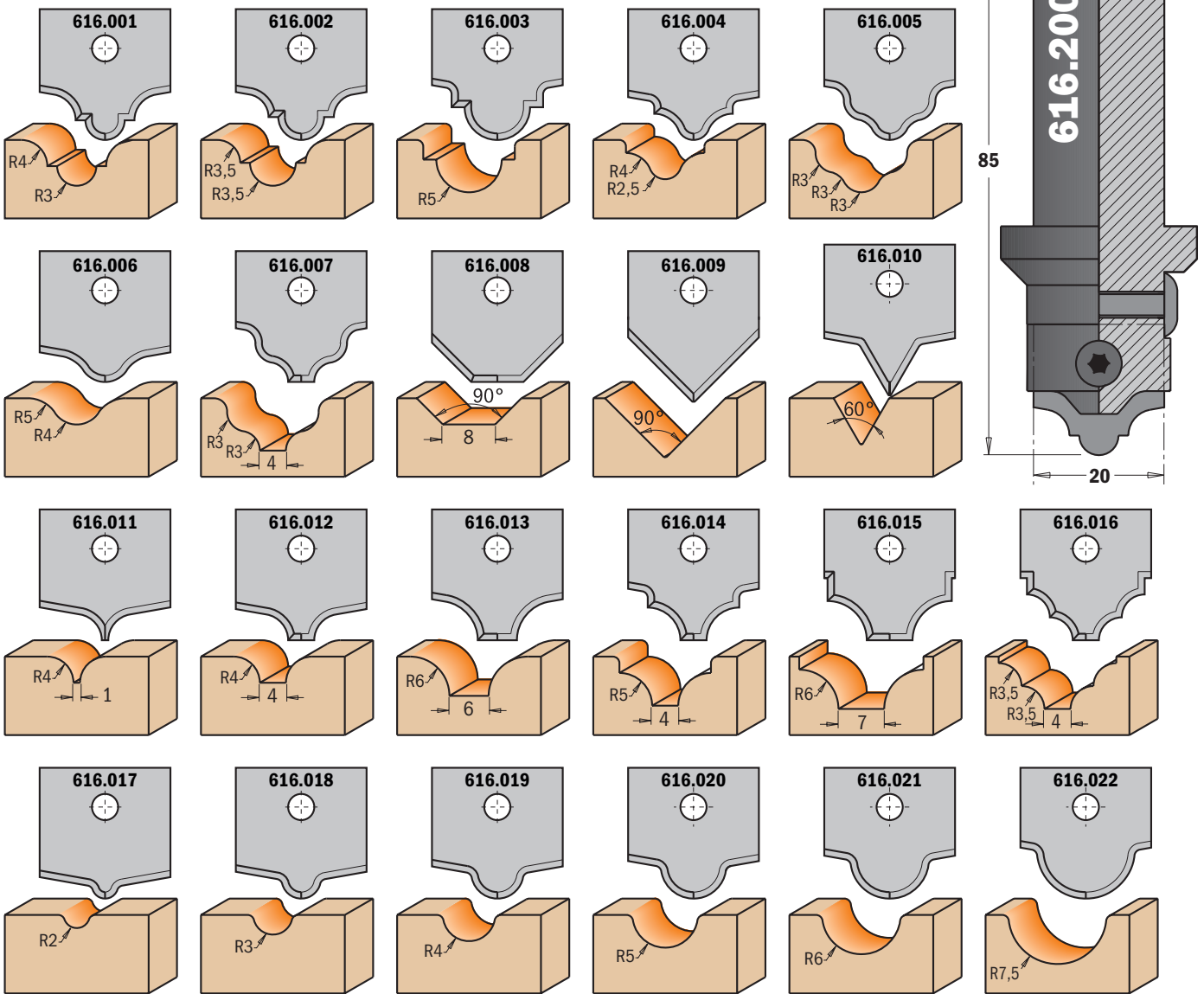

Drawing is 1:1 scale

DESCRIPTION	S mm		ORDER NO. Right-hand rotation	Spare parts		
Complete Set for Decorating on MDF	20	10	616.000.01			
Router cutter body with shank Ø20mm (insert knives not included)	20	10	616.200		990.077.00	991.061.00
Router cutter body with shank Ø12mm (insert knives not included)	12	10	616.120		990.077.00	991.061.00

REMARK: tool body and insert knives can be sold individually.

Complete Set for MDF Doors



615.004.01

Open some new doors with CMT. Our 4-piece set includes the most popular profile to make MDF panel doors for kitchens and bathrooms. Each bit is made from bar stock steel and is equipped with 5 different profile knives allowing enormous possibilities for easy and economical construction. The highest materials, the lowest tolerance in balancing and the precision in the sharpening of the knives let you obtain a smooth finish on your CNC machine.

SAFETY TIPS

The **TW-006** Torque Screwdriver is recommended for the proper fastening of screws (see page 413).



DESCRIPTION	S mm		ORDER NO. Right-hand rotation	Spare parts	
Complete Set for MDF Doors (Profile no. 1)	20	1	615.004.01	990.077.00	991.061.00

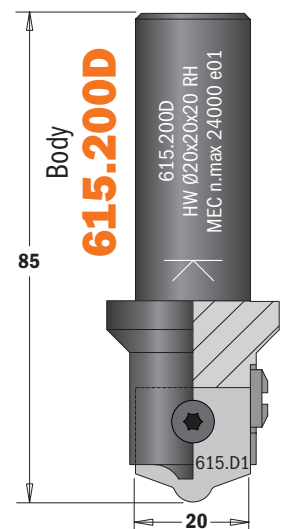
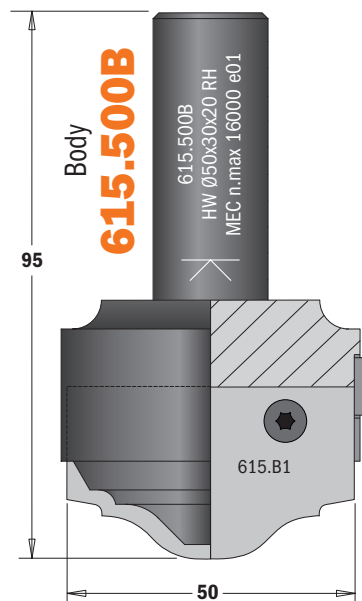
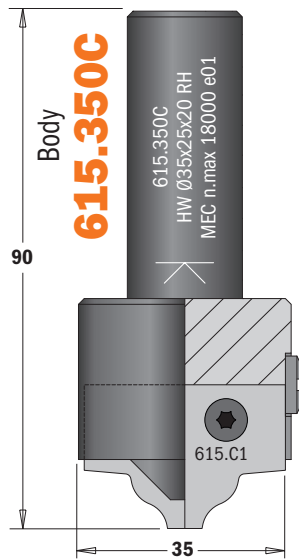
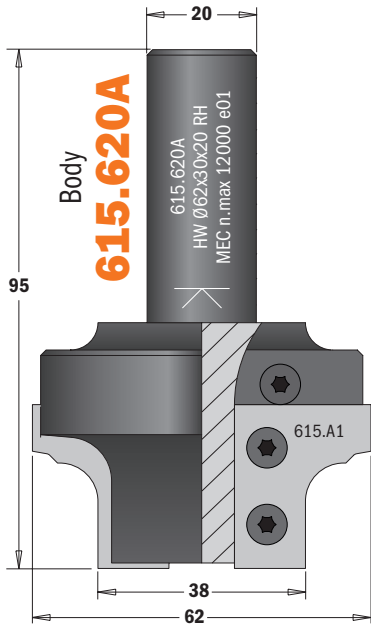

Standard Profile No. 1

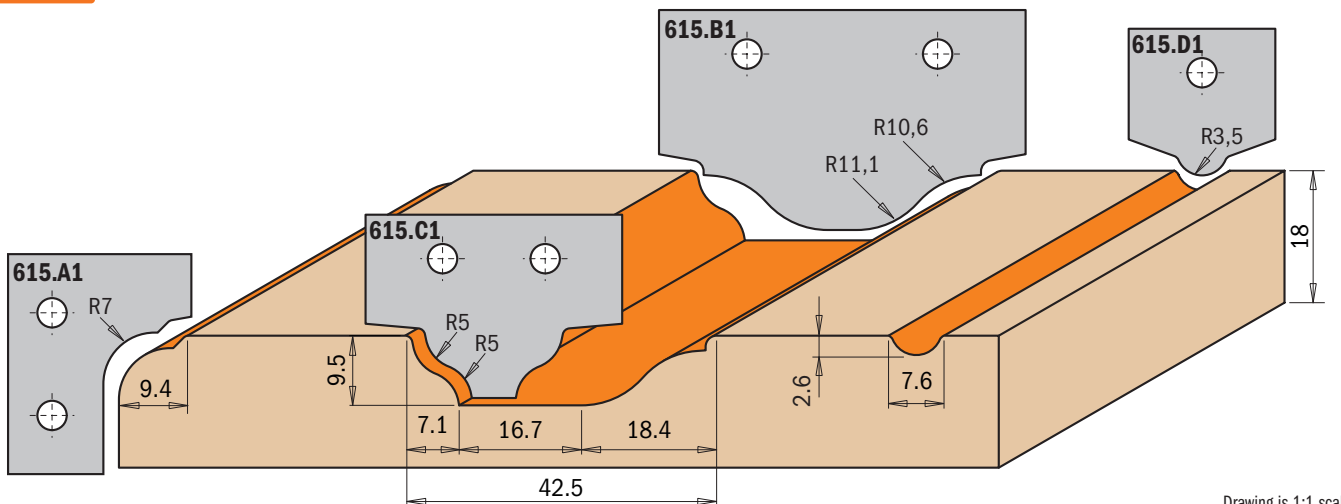

Drawing is 1:1 scale

Optional

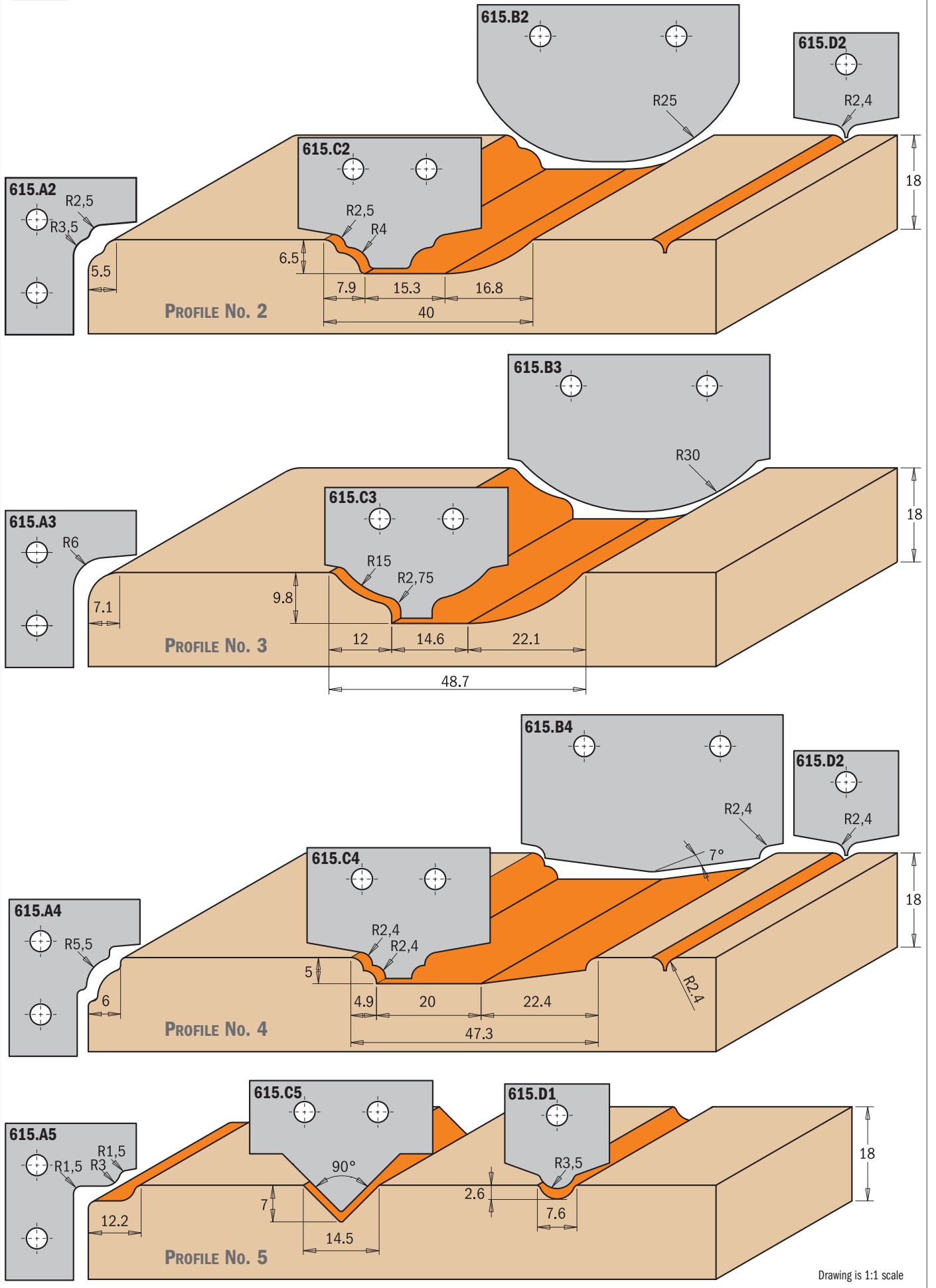

Slot Mortising Bits with Chipbreaker



102



D mm	I mm	L mm	S mm		ORDER NO. Right-hand rotation	ORDER NO. Left-hand rotation
6	50	105	16	10	102.060.31	102.060.32
7	55	110	16	10	102.070.31	102.070.32
8	60	115	16	10	102.080.31	102.080.32
9	65	120	16	10	102.090.31	102.090.32
10	70	125	16	10	102.100.31	102.100.32
11	75	130	16	10	102.110.31	102.110.32
12	80	135	16	10	102.120.31	102.120.32
13	85	140	16	10	102.130.31	102.130.32
14	90	145	16	10	102.140.31	102.140.32
15	95	150	16	10	102.150.31	102.150.32
16	100	155	16	10	102.160.31	102.160.32
17	105	160	16	10	102.170.31	102.170.32
18	110	165	16	10	102.180.31	102.180.32
19	115	170	16	10	102.190.31	102.190.32
20	120	175	16	10	102.200.31	102.200.32
22	125	180	16	10	102.220.31	102.220.32
24	125	180	16	10	102.240.31	102.240.32

172

D mm	I mm	L mm	S mm		ORDER NO. Right-hand rotation	ORDER NO. Left-hand rotation
6	50	105	13	10	172.060.31	172.060.32
7	55	110	13	10	172.070.31	172.070.32
8	60	115	13	10	172.080.31	172.080.32
9	65	120	13	10	172.090.31	172.090.32
10	70	125	13	10	172.100.31	172.100.32
11	75	130	13	10	172.110.31	172.110.32
12	80	135	13	10	172.120.31	172.120.32
13	85	140	13	10	172.130.31	172.130.32
14	90	145	13	10	172.140.31	172.140.32
15	95	150	13	10	172.150.31	172.150.32
16	100	155	13	10	172.160.31	172.160.32
18	110	165	13	10	172.180.31	172.180.32
20	120	175	13	10	172.200.31	172.200.32

TECHNICAL DETAILS:

- Long-lasting cutting performance.
- 2 HL precision ground straight cutting edges with chipbreaker teeth [Z2R].

APPLICATION:

for cutting deep mortise slots in natural soft and medium density wood. For use on combination machining centres equipped with adaptors and/or chucks.

GUIDE TO MACHINING DEEP SLOTS

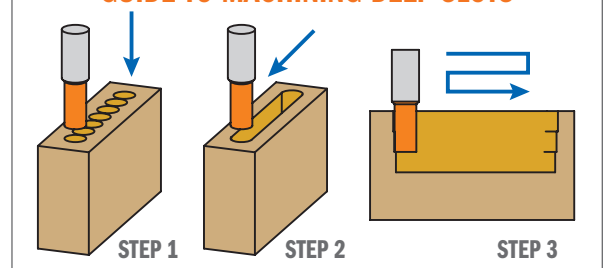

6 Piece Mortising Bit Sets

102 - 172



Our classic set of 6 spiral mortising bits with both Ø16mm and Ø13mm shanks made of super strength high speed steel and available in left-hand or right-hand rotation. Safely packaged in a plastic box for protection, these sets are economical and a perfect addition to any workshop.



S mm	D mm		ORDER NO. Right-hand rotation	ORDER NO. Left-hand rotation
16	6-8-10-12-14-16	1	102.001.00	102.001.10
13	6-8-10-12-14-16	1	172.001.00	172.001.10

Twisted Slot Mortising Bits with Chipbreaker

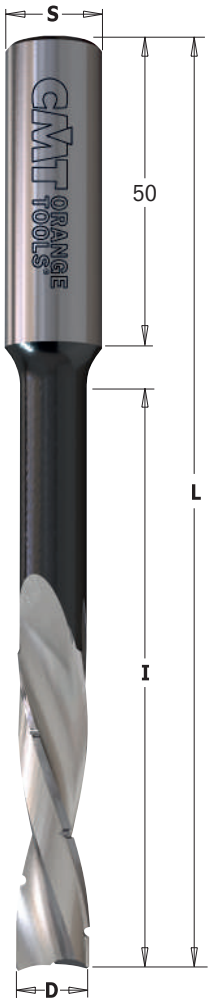

161



D mm	I mm	L mm	S mm		ORDER NO. Right-hand rotation	ORDER NO. Left-hand rotation
6	60	120	16	10	161.060.31	161.060.32
8	70	130	16	10	161.080.31	161.080.32
10	80	140	16	10	161.100.31	161.100.32
12	90	150	16	10	161.120.31	161.120.32
14	100	160	16	10	161.140.31	161.140.32
16	110	170	16	10	161.160.31	161.160.32

160



D mm	I mm	L mm	S mm		ORDER NO. Right-hand rotation	ORDER NO. Left-hand rotation
6	60	120	13	10	160.060.31	160.060.32
8	70	130	13	10	160.080.31	160.080.32
10	80	140	13	10	160.100.31	160.100.32
12	90	150	13	10	160.120.31	160.120.32
14	100	160	13	10	160.140.31	160.140.32
16	110	170	13	10	160.160.31	160.160.32

TECHNICAL DETAILS:

- Long-lasting cutting performance.
- 2 HSS precision ground spiral cutting edges with chipbreaker teeth [Z2R].

APPLICATION:

for cutting mortise slots in soft and hardwood. Used on combined machining centres equipped with chucks.

GUIDE TO MACHINING DEEP SLOTS

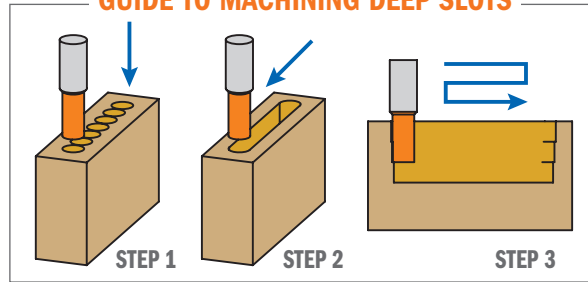

6 Piece Mortising Bit Sets

160 - 161

Ideal for heavy mortise jobs. Made of super strength high speed steel and available in left-hand or right-hand rotation. Safely packaged in a plastic box for protection, these sets are economical and a perfect addition to any workshop.



S mm	D mm		ORDER NO. Right-hand rotation	ORDER NO. Left-hand rotation
16	6-8-10-12-14-16	1	161.001.00	161.001.10
13	6-8-10-12-14-16	1	160.001.00	160.001.10

Carbide Spiral Slot Mortising Bits with Chipbreaker

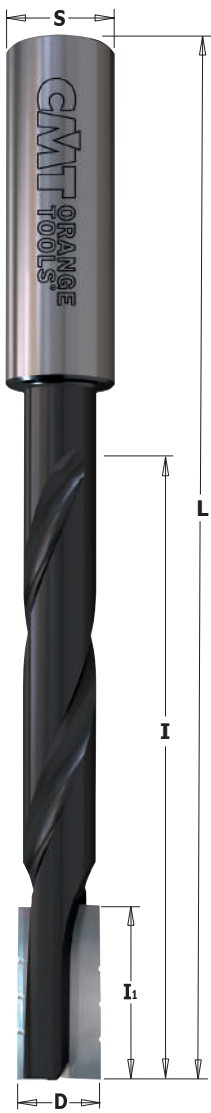

161



D mm	I ₁ mm	I mm	L mm	S mm		ORDER NO. Right-hand rotation	ORDER NO. Left-hand rotation
12	25	75	150	16x50	10	161.120.11	161.120.12
16	25	95	170	16x50	10	161.160.11	161.160.12

TECHNICAL DETAILS:

- Strength steel.
- Long-lasting cutting performance.
- 2 precision ground HW cutting edges with chipbreaker teeth.
- 1 HW plunge centre tip [Z2R+1]

APPLICATION:

for cutting deep mortise slots in natural soft or medium density wood. For use on machining centres equipped with chucks. RPM 3000~5000

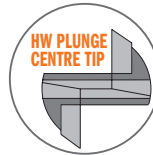

GUIDE TO MACHINING DEEP SLOTS

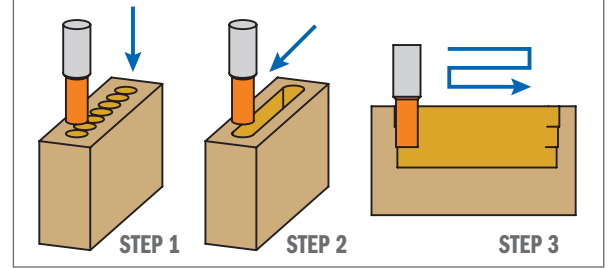

Slot & Mortise Boring Bits

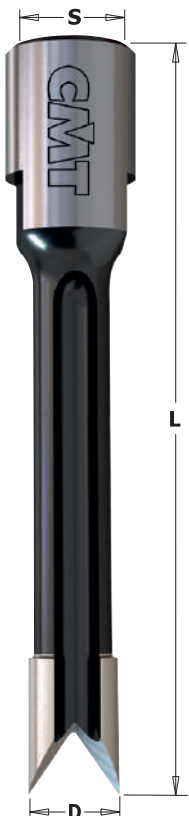

163



D mm	L mm	S mm		ORDER NO. Right-hand rotation
12	100	M12x1	1	163.120.11
14	100	M12x1	1	163.140.11
16	100	M12x1	1	163.160.11

TECHNICAL DETAILS:

- Strength steel.
- 2 HW precision ground cutting edges [Z2].

APPLICATION:

for cutting slots and mortises in solid wood, wood derivatives and laminates. For use on mortising machines equipped with chucks.

Slot & Mortise Boring Bits



164



D mm	L mm	S mm			ORDER NO. Right-hand rotation	
18	100	M12x1		1	164.180.11	
20	100	M12x1		1	164.200.11	
22	100	M12x1		1	164.220.11	

TECHNICAL DETAILS:

- Strength steel.
- HW cutting head with precision balanced centre point.
- 2 HW precision ground cutting edges [Z2].
- 2 negatively HW ground spurs [V2].

APPLICATION:

for drilling blind holes in solid wood, wood composites, plastic and laminated materials. For use on slot and mortise machines equipped with chucks.

Slot & Mortise Boring Bits

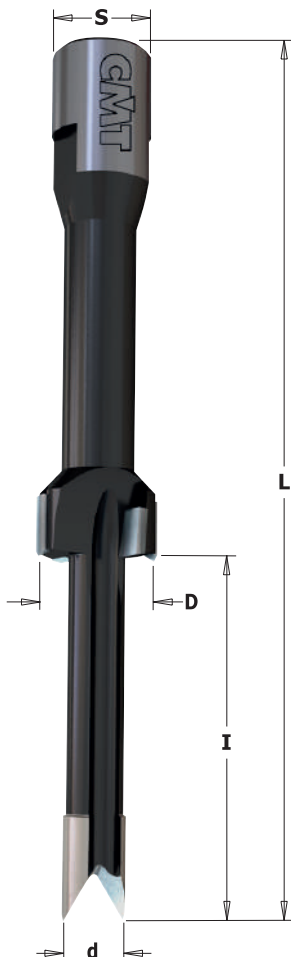

166 - 167



d mm	D mm	I mm	L mm	S mm		ORDER NO. Right-hand rotation	
11	22	62	155	M12x1	1	166.220.11	
12	19	62	155	M12x1	1	167.190.11	

TECHNICAL DETAILS:

- Strength steel.
- 2 HW precision ground cutting edges [Z2].
- 2 negatively HW ground spurs [V2].

APPLICATION:

for creating mortise slots in solid wood, wood derivatives and laminates. For use on slot and mortise machines equipped with chucks.

Reciprocating Slot Mortising Bits



103



D mm	I mm	L mm	S mm		ORDER NO. Right-hand & Left-hand rotation
6	45	100	16	1	103.060.30
7	45	100	16	1	103.070.30
8	45	100	16	1	103.080.30
9	45	100	16	1	103.090.30
10	55	110	16	1	103.100.30
11	55	110	16	1	103.110.30
12	55	110	16	1	103.120.30
13	55	110	16	1	103.130.30
14	55	110	16	1	103.140.30
15	55	110	16	1	103.150.30
16	55	110	16	1	103.160.30

TECHNICAL DETAILS:

- Long-lasting cutter performance.
- 2 HL precision ground cutting edges [Z2].

APPLICATION:

for cutting deep mortise slots in soft and hardwood. For use on combination machining centres equipped with adaptors and/or chucks.

Reciprocating Slot Mortising Bits

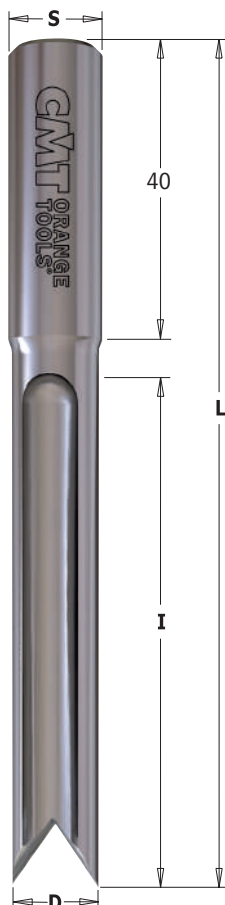

179



D mm	I mm	L mm	S mm		ORDER NO. Right-hand & Left-hand rotation
6	45	90	13	1	179.060.50
7	50	95	13	1	179.070.50
8	50	95	13	1	179.080.50
9	55	100	13	1	179.090.50
10	60	105	13	1	179.100.50
11	65	110	13	1	179.110.50
12	70	115	13	1	179.120.50
13	75	120	13	1	179.130.50

TECHNICAL DETAILS:

- Long-lasting cutter performance.
- 2 HSS precision ground cutting edges [Z2].

APPLICATION:

for cutting deep mortise slots in natural soft or medium density wood. For use on combination machining centres equipped with adaptors and/or chucks.

Reciprocating Slot Mortising Bits



104



D mm	I mm	L mm	S mm		ORDER NO. Right-hand & Left-hand rotation
6	45	100	13	1	104.060.30
7	45	100	13	1	104.070.30
8	45	100	13	1	104.080.30
9	45	100	13	1	104.090.30
10	55	110	13	1	104.100.30
11	55	110	13	1	104.110.30
12	55	110	13	1	104.120.30
13	55	110	13	1	104.130.30
14	55	110	13	1	104.140.30
15	55	110	13	1	104.150.30
16	55	110	13	1	104.160.30

TECHNICAL DETAILS:

- Long-lasting cutting performance.
- 4 HL precision ground cutting edges [Z4].

APPLICATION:

for cutting deep mortise slots in soft and medium density wood. For use on mortising machine centres equipped with chucks.

Reciprocating Slot Mortising Bits

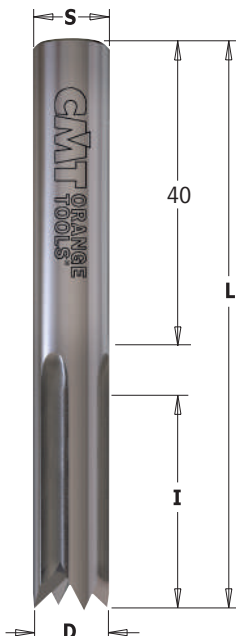

105



D mm	I mm	L mm	S mm		ORDER NO. Right-hand & Left-hand rotation
6	28	73	10	1	105.060.30
7	28	73	10	1	105.070.30
8	28	73	10	1	105.080.30
9	28	73	10	1	105.090.30
10	28	73	10	1	105.100.30
11	28	73	10	1	105.110.30
12	28	73	10	1	105.120.30
13	28	73	10	1	105.130.30
14	28	73	10	1	105.140.30
15	28	73	10	1	105.150.30
16	28	73	10	1	105.160.30

TECHNICAL DETAILS:

- Long-lasting cutting performance.
- 4 HL precision ground cutting edges [Z4].

APPLICATION:

for cutting deep mortise slots in natural soft and medium density wood. For use on mortising machine centres equipped with chucks.

Reciprocating Slot Mortising Bits

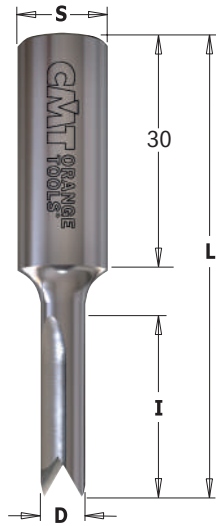

106



D mm	I mm	L mm	S mm	Z		ORDER NO. Right-hand & Left-hand rotation
6	25	60	12	2	1	106.060.30
7	25	60	12	2	1	106.070.30
8	25	60	12	2	1	106.080.30
9	25	60	12	2	1	106.090.30
10	25	60	12	4	1	106.100.30
11	25	60	12	4	1	106.110.30
12	25	60	12	4	1	106.120.30
13	25	60	12	4	1	106.130.30
14	25	60	12	4	1	106.140.30
15	25	60	12	4	1	106.150.30

TECHNICAL DETAILS:

- Long-lasting cutter performance.
- 2 or 4 HL precision ground cutting edges [Z2-Z4].

Slot Mortising Bits

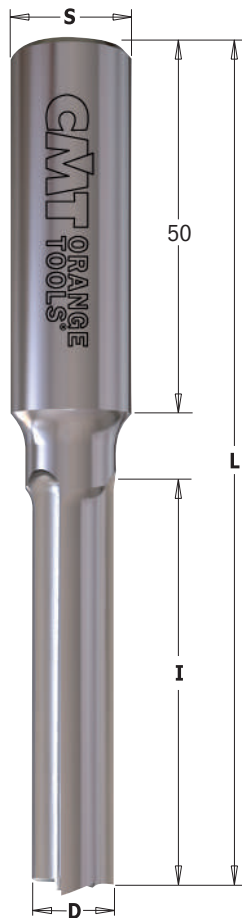

107



D mm	I mm	L mm	S mm		ORDER NO. Right-hand rotation	ORDER NO. Left-hand rotation
6	55	110	16	1	107.060.31	107.060.32
8	55	110	16	1	107.080.31	107.080.32
10	55	110	16	1	107.100.31	107.100.32
12	55	110	16	1	107.120.31	107.120.32
14	60	115	16	1	107.140.31	107.140.32
16	60	115	16	1	107.160.31	107.160.32
18	60	115	16	1	107.180.31	107.180.32
20	60	115	16	1	107.200.31	107.200.32

TECHNICAL DETAILS:

- Long-lasting cutter performance.
- 3 HL precision ground cutting edges [Z3].

APPLICATION:



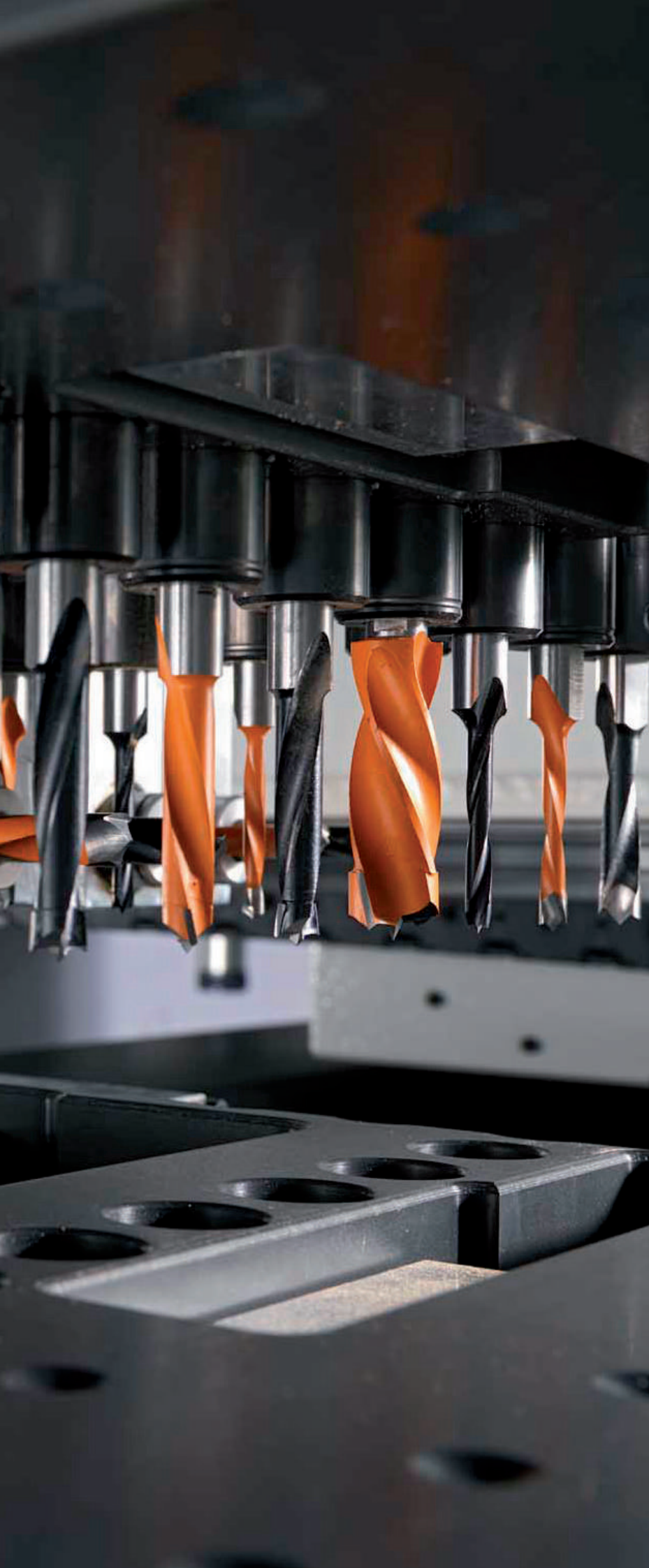



for cutting mortise slots in natural soft and medium density wood. For use on combination machining centres equipped with chucks.



INDUSTRIAL DOWEL DRILLS

PRODUCTS	PAGE
XTreme Solid Carbide Boring Bits	329~331
XTreme Boring Bits	332~333
Solid Carbide Twist Drills	334
Adaptors & Bushings for Twist Drills	335
2 Flute Dowel Drills	336~337
4 Flute Dowel Drills	338~340
Dowel Drills with Countersink	341
Through Hole Dowel Drills	342~343
Countersinks	344
Adaptors	345~347
Hinge Boring Bits	349~351
Dowel Drills with Threaded Shank	352~354

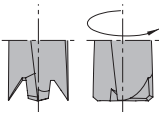
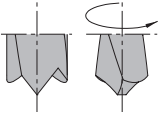
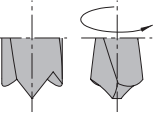
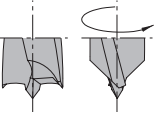

LINE	XTREME FLAT-HWM	XTREME-HWM	XTREME	INDUSTRIAL
PERFORMANCE	★★★★★	★★★★★	★★★★★	★★★
BIT				
DESCRIPTION	Designed for heavy duty drilling in Large-Scale Industrial Manufacturing ensuring high impact resistance and greater durability.	Designed for heavy duty drilling in Large-Scale Industrial Manufacturing ensuring high impact resistance and greater durability.	Designed for heavy-duty to medium-duty drilling in large-scale to medium-scale industrial manufacturing ensuring high impact resistance and greater durability.	Designed for medium-duty to light-duty drilling in medium-scale to small-scale industrial manufacturing ensuring rigorous impact resistance and good durability.
USER	LARGE-SCALE INDUSTRIAL MANUFACTURING	LARGE-SCALE INDUSTRIAL MANUFACTURING	LARGE-SCALE TO MEDIUM-SCALE INDUSTRIAL MANUFACTURING	MEDIUM-SCALE TO SMALL-SCALE INDUSTRIAL MANUFACTURING
RECOMMENDED USE	INDUSTRIAL PRODUCTION	INDUSTRIAL PRODUCTION	INDUSTRIAL/CABINETMAKER'S	CABINETMAKER'S
MATERIALS	Ideal for chipboard, MDF, HDF and laminates. Nonprotruding center-point and spurs make this tool perfect for low-thickness panels.	Ideal for chipboard, MDF, HDF and laminates.	Excellent for both hard and soft wood. Great for chipboard, MDF, HDF and laminates.	Excellent for both hard and soft wood. Good for chipboard, MDF, and laminates.
SHARPENING & MAINTENANCE	Flat edges with reinforced spurs allow perfect finishing and prolonged drilling.  XTREME FLAT SHARPENING	Specially designed reinforced spurs allow for impeccable finishing during operations involving high-speed cutting feed.  XTREME SHARPENING	Specially designed reinforced spurs allow for impeccable finishing during operations involving high-speed cutting feed.  XTREME SHARPENING	Standard design with negatively ground spurs providing good quality finishing without chipping.  NEGATIVELY GROUND SPURS
CARBIDE	INDUSTRIAL CHROMIUM MICROGRAIN CARBIDE The premium quality carbide produces clean bores with no rough edges and maintains a balanced center point. In addition to its safety features, Chromium Micrograin Carbide guarantees exceptional resistance to fatigue and abrasion and allows for an infinite number of resharpenings.	INDUSTRIAL CHROMIUM MICROGRAIN CARBIDE The special chromium enhanced carbide produces clean bores with no rough edges and maintains a balanced center point. In addition to its safety features, Chromium Micrograin Carbide guarantees exceptional resistance to fatigue and abrasion and allows for an infinite number of resharpenings.	INDUSTRIAL SINTERHIP HI-DENSITY CARBIDE The unique tip is made of high quality carbide enhanced via Sinterhip (hot isostatic pressing). This process guarantees long lasting performance and exceptionally clean bores.	INDUSTRIAL GRADE CARBIDE Fine and medium grain carbide grade guarantee reliable prolonged use.
COATING	 SOLID TUNGSTEN CARBIDE	 SOLID TUNGSTEN CARBIDE	C.M.T. P.T.F.E. Coating provides a non-stick surface preventing resin, glue or sludge residue accumulation on the bit body. Baked at 420°, this unique industrial material is specifically designed to fit woodworking tool requirements.	C.M.T. P.T.F.E. Coating provides a non-stick surface preventing resin, glue or sludge residue accumulation on the bit body. Baked at 420°, this unique industrial material is specifically designed to fit woodworking tool requirements.
PRICE RANGE	HIGH	HIGH	MEDIUM/HIGH	MEDIUM

Solid Carbide Dowel Drills - LONG LIFE SHARPENING

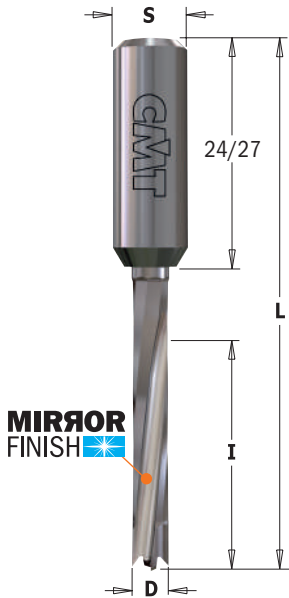

311.71/72 XTREME FLAT SHARPENING



D mm	I mm	L mm	S mm		ORDER NO. Right-hand rotation	ORDER NO. Left-hand rotation
5	30	70	10x27	50	311.050.71	311.050.72
6	30	70	10x27	50	311.060.71	311.060.72
7	30	70	10x27	50	311.070.71	311.070.72
8	30	70	10x24	50	311.080.71	311.080.72
10	30	70	10x26	50	311.100.71	311.100.72

TECHNICAL DETAILS:

- Premium quality strength steel shank.
- High quality HWM body with mirror finishing.
- 2 cutting edges [Z2] + 2 curved ground spurs [V2].
- 2 spiral flutes.
- Parallel shank with driving flat and adjustable screw length.
- Recommended feed speed 1~4m/minute - RPM 6000.

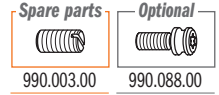

APPLICATION:

ideal for chipboard, MDF, HDF and laminates.
No center-point or spurs means perfect bores in low-thickness panels.
For use on boring machines equipped with adaptors/chucks.

CMT's new high quality dowel drills guarantee excellent performance and extra-long life!

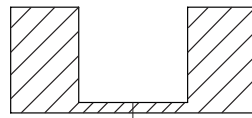
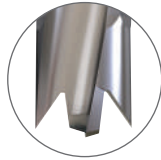
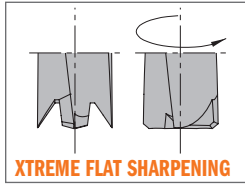

Flat sharpening with no center-point or spurs

Solid Carbide Dowel Drills - LONG LIFE SHARPENING

new

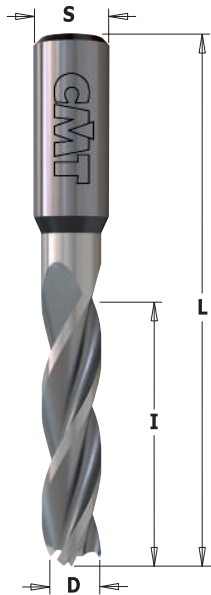

311.31/32 XTREME



3X
LONGER LIFE
THAN STANDARD

D mm	I mm	L mm	S mm		ORDER NO. Right-hand rotation	ORDER NO. Left-hand rotation
5	30	70	10x30	50	311.050.31	311.050.32
8	35	70	10x25	50	311.080.31	311.080.32

TECHNICAL DETAILS:

- Premium quality strength steel shank.
- High quality HWM body.
- 3 cutting edges [Z3] + 3 negatively ground spurs [V3].
- 3 spiral flutes.
- Balanced centre point.
- Parallel shank with driving flat and adjustable screw length.

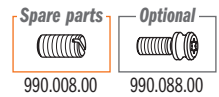

APPLICATION:

for drilling blind holes in solid wood, wood derivatives and laminates.
For use on boring machine equipped with adaptors and/or chucks.

REMARK: special dimensions available on request.

CMT's new high quality dowel drills guarantee excellent performance and extra-long life!

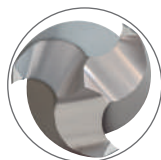
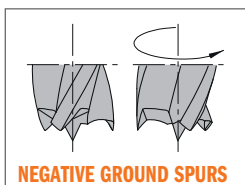

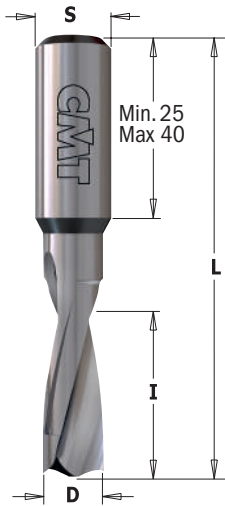

310.21/22 XTREME



D mm	I mm	L mm	S mm		ORDER NO. Right-hand rotation	ORDER NO. Left-hand rotation
1,3	5	57,5	10x30	50	310.013.20*	
2	12	57,5	10x27	50	310.020.21	310.020.22
3	9	57,5	10x40	50	310.530.21	310.530.22
3	18	57,5	10x25	50	310.030.21	310.030.22
4	20	57,5	10x27	50	310.040.21	310.040.22
5	22	57,5	10x27	50	310.050.21	310.050.22
6	22	57,5	10x27	50	310.060.21	310.060.22
6,35 (1/4")	22	57,5	10x27	50	310.064.21	310.064.22
8	22	57,5	10x27	50	310.080.21	310.080.22
10	22	57,5	10x25	50	310.100.21	310.100.22

* Boring bit for panel preboring.
Suitable for both right-hand and left-hand rotation.

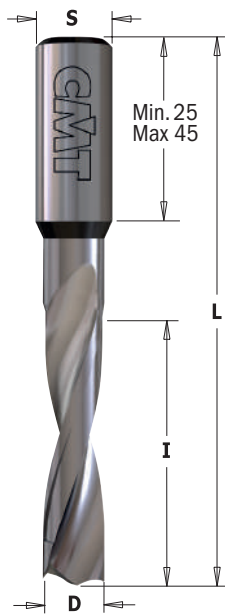
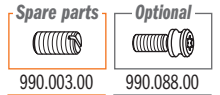

311.21/22 XTREME



D mm	I mm	L mm	S mm		ORDER NO. Right-hand rotation	ORDER NO. Left-hand rotation
1,3	5	70	10x45	50	311.013.20*	
2	12	70	10x40	50	311.020.21	311.020.22
3	18	70	10x42	50	311.030.21	311.030.22
3,5	18	70	10x39	50	311.035.21	311.035.22
4	30	70	10x28	50	311.040.21	311.040.22
5	30	70	10x30	50	311.050.21	311.050.22
6	30	70	10x27	50	311.060.21	311.060.22
6,35 (1/4")	30	70	10x30	50	311.064.21	311.064.22
7	35	70	10x25	50	311.070.21	311.070.22
8	35	70	10x25	50	311.080.21	311.080.22
10	35	70	10x25	50	311.100.21	311.100.22

* Boring bit for panel preboring.
Suitable for both right-hand and left-hand rotation.

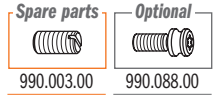

TECHNICAL DETAILS:

- Premium quality strength steel shank.
- High quality HWM body.
- 2 cutting edges [Z2] + 2 curved ground spurs [V2].
- 2 spiral flutes.
- Balanced centre point.
- Parallel shank with driving flat and adjustable screw length.

APPLICATION:

for drilling blind holes in solid wood, wood derivatives and laminates.
For use on boring machines equipped with adaptors and/or with chucks.

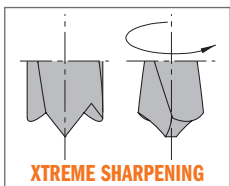

Grinding Wheels for Xtreme Sharpening



01.02

D mm	DESCRIPTION	DIMENSION mm	B mm		ORDER NO.
Ø3 a 7	Grinding wheel for resharpening	Ø125x5,5	Ø20	1	01.02.0316
Ø8 a 10	Grinding wheel for resharpening	Ø125x7	Ø20	1	01.02.0317

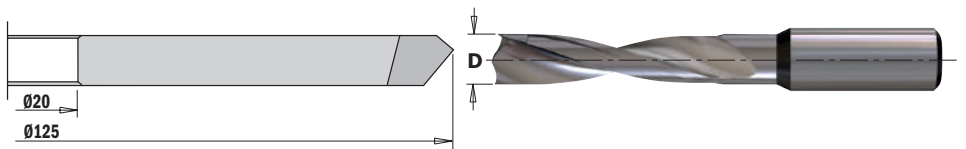

Solid Carbide Dowel Drills for Through Holes - LONG LIFE SHARPENING

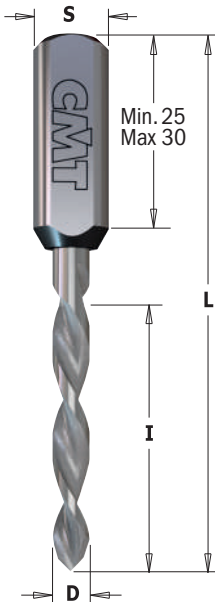

314.21/22 XTREME



D mm	I mm	L mm	S mm		ORDER NO. Right-hand rotation	ORDER NO. Left-hand rotation
*3	27	70	10x30	50	314.030.21	314.030.22
4	35	70	10x25	50	314.040.21	314.040.22
5	35	70	10x25	50	314.050.21	314.050.22
6	35	70	10x25	50	314.060.21	314.060.22
7	35	70	10x25	50	314.070.21	314.070.22
8	35	70	10x25	50	314.080.21	314.080.22
10	35	70	10x27	50	314.100.21	314.100.22

* "V" point 60° sharpening

TECHNICAL DETAILS:

- Premium quality strength steel shank.
- High quality HWM body.
- 2 cutting edges [Z2] with double angle.
- 2 spiral flutes.
- Parallel shank with driving flat and adjustable screw length.

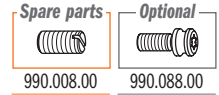

APPLICATION:

for drilling through holes in solid wood, wood derivatives and laminates.
For use on boring machine equipped with adaptors and/or chucks.

FOR PANELS WITH MAXIMUM THICKNESS: 20-30mm

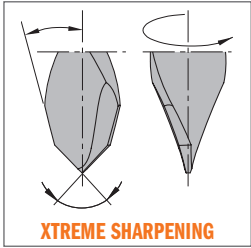

Solid Carbide Dowel Drills - LONG LIFE SHARPENING

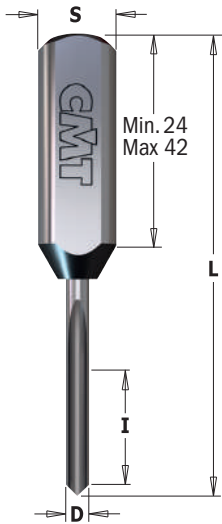

382 XTREME



D mm	I mm	L mm	S mm		ORDER NO. Right-hand & Left-hand rotation
2	12	57,5	10x30	50	382.2057
2	12	70	10x42	50	382.2070
2,5	16	57,5	10x24	50	382.2557
2,5	16	70	10x35	50	382.2570
3	15	57,5	10x26	50	382.3057
3	25	70	10x26	50	382.3070
3,5	18	57,5	10x24	50	382.3557
3,5	18	70	10x36	50	382.3570
5	25	57,5	10x25	50	382.5057
5	35	70	10x25	50	382.5070

TECHNICAL DETAILS:

- Premium quality strength steel shank.
- High quality HWM body.
- 1 cutting edge [Z1].
- Parallel shank with driving flat and adjustable screw length.

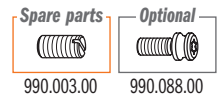

APPLICATION:

for drilling blind holes in solid wood, wood derivatives, plastic, laminates and melamine.
For use on boring machine, point-to-point machines and hand-held routers equipped with adaptors and/or chucks.

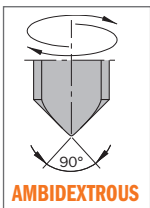

SECURITY TIPS:
These boring bits require more power compared to tradition dowel drills.
The number of boring bits to be used in a single drilling unit depends on the machine power.

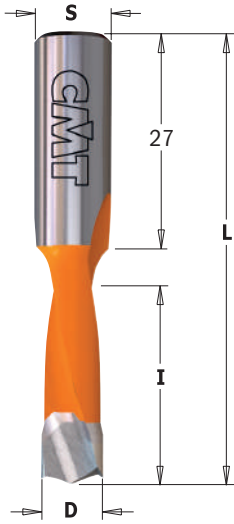

310.41/42 XTREME



D mm	I mm	L mm	S mm		ORDER NO. Right-hand rotation	ORDER NO. Left-hand rotation
5	27	57,5	10x27	50	310.050.41	310.050.42
6	27	57,5	10x27	50	310.060.41	310.060.42
7	27	57,5	10x27	50	310.070.41	310.070.42
8	27	57,5	10x27	50	310.080.41	310.080.42
9	27	57,5	10x27	50	310.090.41	310.090.42
10	27	57,5	10x27	50	310.100.41	310.100.42

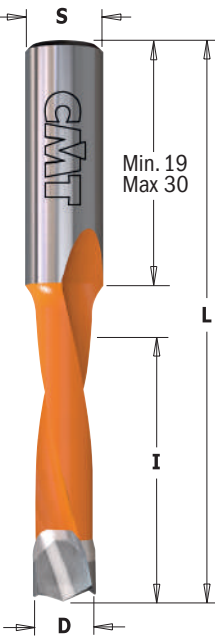
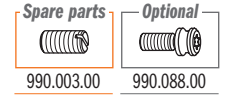

311.41/42 XTREME



D mm	I mm	L mm	S mm		ORDER NO. Right-hand rotation	ORDER NO. Left-hand rotation
5	35	70	10x30	50	311.050.41	311.050.42
6	35	70	10x30	50	311.060.41	311.060.42
7	35	70	10x30	50	311.070.41	311.070.42
8	35	70	10x30	50	311.080.41	311.080.42
8	45	70	10x19	50	311.580.41*	311.580.42*
9	35	70	10x30	50	311.090.41	311.090.42
10	35	70	10x30	50	311.100.41	311.100.42
12	35	70	10x30	10	311.120.41	311.120.42

* Drill bits designed to fit HÄFELE® one-piece Ixconnect SC 8/60 spreading connector.

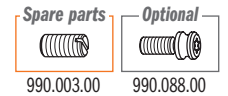

TECHNICAL DETAILS:

- Premium quality strength steel body.
- High quality HW tip.
- 2 cutting edges [Z2] + 2 curved ground spurs [V2].
- 2 spiral flutes.
- Balanced centre point.
- Orange or black P.T.F.E. coating.
- Parallel shank with driving flat and adjustable screw length.

APPLICATION:

for drilling blind holes in solid wood, wood derivatives, plastics and laminates. For use on boring machines equipped with adaptors and/or chucks.

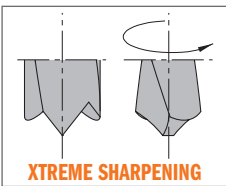

Grinding Wheels for Xtreme Sharpening



01.02

D mm	DESCRIPTION	DIMENSION mm	B mm		ORDER NO.
Ø3 a 7	Grinding wheel for resharpening	Ø125x5,5	Ø20	1	01.02.0316
Ø8 a 10	Grinding wheel for resharpening	Ø125x7	Ø20	1	01.02.0317

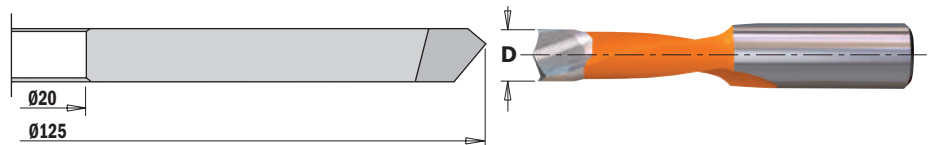

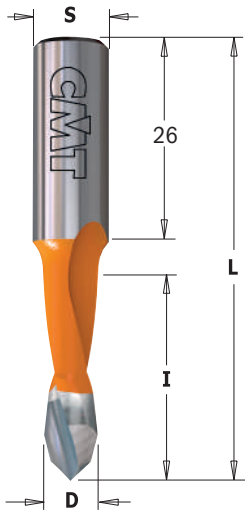

313.41/42 XTREME

HW LONG LIFE Z2 RH LH

D mm	I mm	L mm	S mm		ORDER NO. Right-hand rotation	ORDER NO. Left-hand rotation
5	27	57,5	10x26	50	313.050.41	313.050.42
8	27	57,5	10x26	50	313.080.41	313.080.42

TECHNICAL DETAILS:

- Premium quality strength steel body.
- High quality HW tip.
- 2 cutting edges [Z2] with double angle.
- 2 spiral flutes.
- Orange or black P.T.F.E. coating.
- Parallel shank with driving flat and adjustable screw length.

Spare parts 990.003.00
Optional 990.088.00

APPLICATION:

for drilling through holes in solid wood, wood derivatives and laminates.
For use on boring machines equipped with adaptors and/or chucks.

FOR PANELS WITH MAXIMUM THICKNESS: 20mm

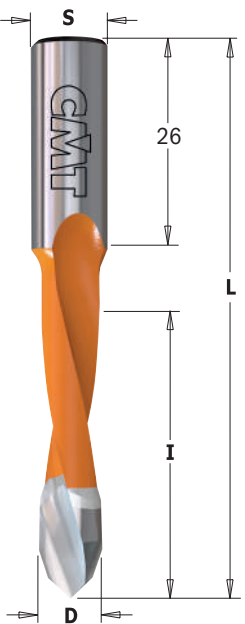

314.41/42 XTREME

HW LONG LIFE Z2 RH LH

D mm	I mm	L mm	S mm		ORDER NO. Right-hand rotation	ORDER NO. Left-hand rotation
5	35	70	10x26	50	314.050.41	314.050.42
6	35	70	10x26	50	314.060.41	314.060.42
7	35	70	10x26	50	314.070.41	314.070.42
8	35	70	10x26	50	314.080.41	314.080.42
10	35	70	10x26	50	314.100.41	314.100.42

TECHNICAL DETAILS:

- Premium quality strength steel body.
- High quality HW tip.
- 2 cutting edges [Z2] with double angle.
- 2 spiral flutes.
- Orange or black P.T.F.E. coating.
- Parallel shank with driving flat and adjustable screw length.

Spare parts 990.003.00
Optional 990.088.00

APPLICATION:

for drilling through holes in solid wood, wood derivatives and laminates.
For use on boring machines equipped with adaptors and/or chucks.

FOR PANELS WITH MAXIMUM THICKNESS: 30mm

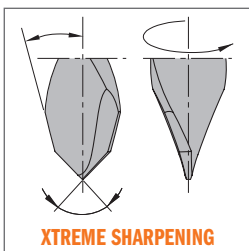

Solid Carbide Twist Drills "V" Point 120° - LONG LIFE SHARPENING

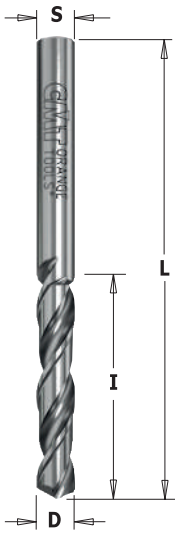

"V" POINT 120°

363.11/12



S=D mm	I mm	L mm		ORDER NO. Right-hand rotation	ORDER NO. Left-hand rotation
2	25	50		363.020.11	363.020.12
2,5	27	55	50	363.025.11	363.025.12
3	27	55	50	363.030.11	363.030.12
3,2	27	55	50	363.032.11	363.032.12
3,5	27	55	50	363.035.11	363.035.12
4	27	55	50	363.040.11	363.040.12
4,5	28	60	50	363.045.11	363.045.12
5	28	60	50	363.050.11	363.050.12

For use with the following items: **364-365**

TECHNICAL DETAILS:

- High quality HWM body.
- 2 cutting edges [Z2] at 120°.
- 2 spiral flutes.

APPLICATION:

for drilling through holes in solid wood, wood derivatives and laminates.
For use on boring machines equipped with adaptors and/or chucks.

Solid Carbide Twist Drills "V" Point 60° - LONG LIFE SHARPENING

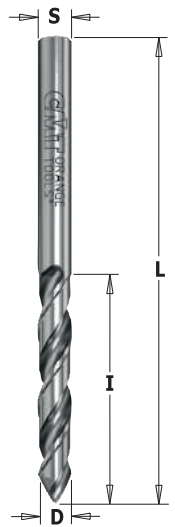

"V" POINT 60°

363.41/42



S=D mm	I mm	L mm		ORDER NO. Right-hand rotation	ORDER NO. Left-hand rotation
2,5	27	55		363.025.41	363.025.42
3	27	55	50	363.030.41	363.030.42
3,5	27	55	50	363.035.41	363.035.42
4	27	55	50	363.040.41	363.040.42

For use with the following items: **364-365**

TECHNICAL DETAILS:

- High quality HWM body.
- 2 cutting edges [Z2] at 60°.
- 2 spiral flutes.

APPLICATION:

for drilling through holes in solid wood, wood derivatives and laminates.
For use on boring machines equipped with adaptors and/or chucks.

Solid Carbide Twist Drills Negatively Ground Spurs - LONG LIFE SHARPENING

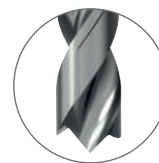

XTREME SHARPENING

363.21/22 XTREME



S=D mm	I mm	L mm		ORDER NO. Right-hand rotation	ORDER NO. Left-hand rotation
2,5	27	55		363.025.21	363.025.22
3	27	55	50	363.030.21	363.030.22
4	27	55	50	363.040.21	363.040.22
5	28	60	50	363.050.21	363.050.22

For use with the following items: **364-365**

TECHNICAL DETAILS:

- High quality HWM body.
- 2 cutting edges [Z2] + 2 curved ground spurs [V2].
- 2 spiral flutes.

APPLICATION:

for drilling blind holes in solid wood, wood derivatives and laminates.
For use on boring machines equipped with adaptors and/or chucks.

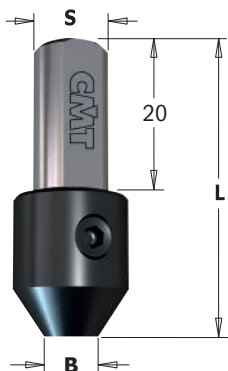

364

B mm	L mm	S mm		ORDER NO.
2	38	10x20	10	364.020.00
2,5	38	10x20	10	364.025.00
3	38	10x20	10	364.030.00
3,2	38	10x20	10	364.032.00
3,5	38	10x20	10	364.035.00
4	38	10x20	10	364.040.00
4,5	38	10x20	10	364.045.00
5	38	10x20	10	364.050.00

For use with the following items: **363** HWM

Spare parts	
990.001.00	991.062.00

TECHNICAL DETAILS:

- Strength steel.
- Precision grinding on all contact surfaces.
- Quick and secure assembly of the twist drills with screw.
- Parallel shank with driving flat.

APPLICATION:

for use with twist drills with common shank and bushing diameter.
For use on boring machines equipped with adaptors and/or chucks.

Bushings for Twist Drills

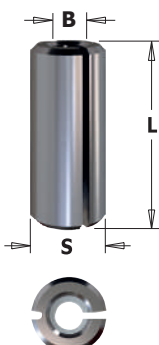

365

B mm	L mm	S mm		ORDER NO.
2	23	10	50	365.020.00
2,5	23	10	50	365.025.00
3	23	10	50	365.030.00
3,2	23	10	50	365.032.00
3,5	23	10	50	365.035.00
4	23	10	50	365.040.00
4,5	23	10	50	365.045.00
5	23	10	50	365.050.00
6	23	10	50	365.060.00

For use with the following items: **363** HWM

TECHNICAL DETAILS:

- Strength steel.
- Precision grinding on all contact surfaces.
- Axial cuttings for cylindrical drill clamps.
- Parallel shank with driving flat.

APPLICATION:

for use with twist drills with common shank and bushing diameter. For use on boring machines equipped with adaptors and/or chucks.

ASSEMBLY ILLUSTRATION

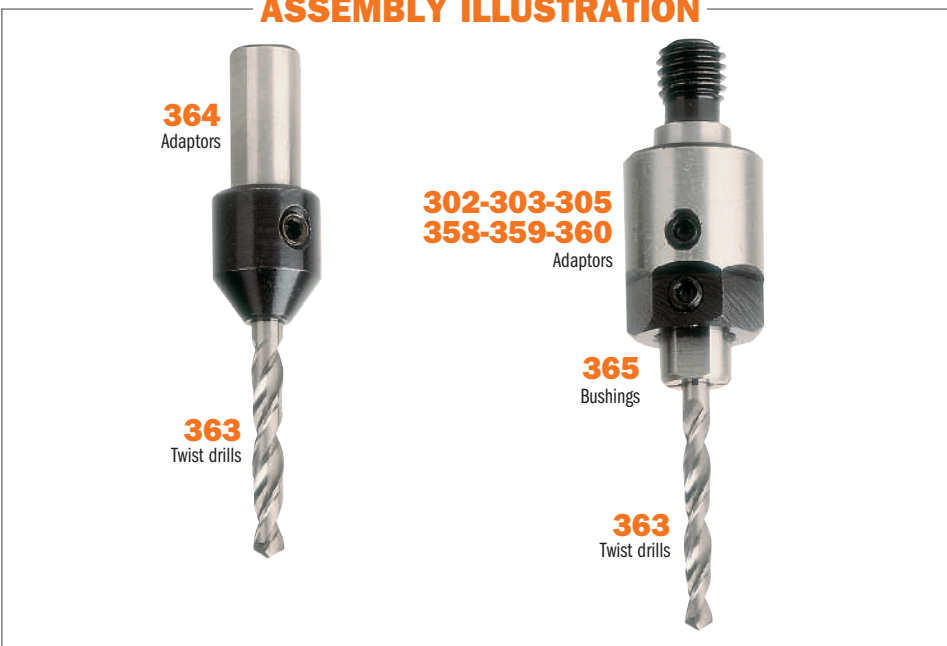

2 Flute Dowel Drills

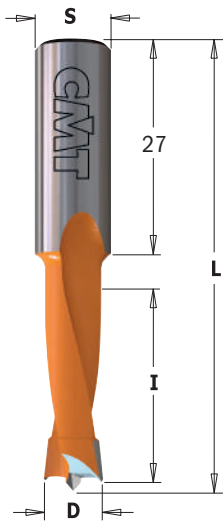

310

HW **Z2** **V2** **RH** **LH**

D mm	I mm	L mm	S mm		ORDER NO. Right-hand rotation	ORDER NO. Left-hand rotation
4	27	57,5	10x27	50	310.040.11	310.040.12
4,5	27	57,5	10x27	50	310.045.11	310.045.12
4,76	27	57,5	10x27	50	310.047.11	310.047.12
5	27	57,5	10x27	50	310.050.11	310.050.12
5,1	27	57,5	10x27	50	310.051.11	310.051.12
5,2	27	57,5	10x27	50	310.052.11	310.052.12
5,55	27	57,5	10x27	50	310.055.11	310.055.12
6	27	57,5	10x27	50	310.060.11	310.060.12
6,35	27	57,5	10x27	50	310.064.11	310.064.12
6,5	27	57,5	10x27	50	310.065.11	310.065.12
7	27	57,5	10x27	50	310.070.11	310.070.12
8	27	57,5	10x27	50	310.080.11	310.080.12
8,2	27	57,5	10x27	50	310.082.11	310.082.12
9	27	57,5	10x27	50	310.090.11	310.090.12
9,52	27	57,5	10x27	50	310.095.11	310.095.12
10	27	57,5	10x27	50	310.100.11	310.100.12
11	27	57,5	10x27	10	310.110.11	310.110.12
12	27	57,5	10x27	10	310.120.11	310.120.12
12,7	27	57,5	10x27	10	310.127.11	310.127.12
13	27	57,5	10x27	10	310.130.11	310.130.12
14	27	57,5	10x27	10	310.140.11	310.140.12
15	27	57,5	10x27	10	310.150.11	310.150.12
16	27	57,5	10x27	10	310.160.11	310.160.12

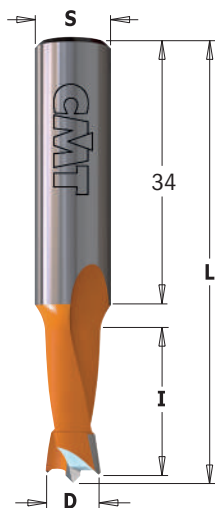
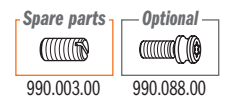

361

HW **Z2** **V2** **RH** **LH**

D mm	I mm	L mm	S mm		ORDER NO. Right-hand rotation	ORDER NO. Left-hand rotation
5	18	57,5	10x34	50	361.050.11	361.050.12
6	18	57,5	10x34	50	361.060.11	361.060.12
7	18	57,5	10x34	50	361.070.11	361.070.12
8	18	57,5	10x34	50	361.080.11	361.080.12
10	18	57,5	10x34	50	361.100.11	361.100.12

TECHNICAL DETAILS:

- Premium quality strength steel body.
- High quality HW tip.
- 2 cutting edges [Z2] + 2 negatively ground spurs [V2].
- 2 spiral flutes.
- Balanced centre point.
- Orange or black P.T.F.E. coating.
- Parallel shank with driving flat and length adjusting screw.

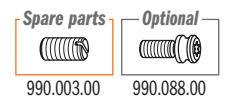

APPLICATION:

for drilling blind holes in solid wood, wood derivatives and laminates.
For use on boring machine equipped with adaptors and/or chucks.

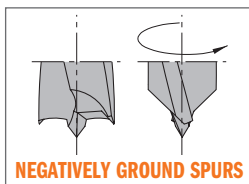

HW Z2 V2 RH LH

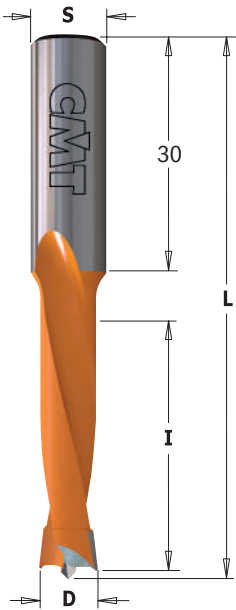

311

D mm	I mm	L mm	S mm		ORDER NO. Right-hand rotation	ORDER NO. Left-hand rotation
4	35	70	10x30	50	311.040.11	311.040.12
4,5	35	70	10x30	50	311.045.11	311.045.12
4,76	35	70	10x30	50	311.047.11	311.047.12
5	35	70	10x30	50	311.050.11	311.050.12
5,1	35	70	10x30	50	311.051.11	311.051.12
5,2	35	70	10x30	50	311.052.11	311.052.12
5,55	35	70	10x30	50	311.055.11	311.055.12
6	35	70	10x30	50	311.060.11	311.060.12
6,35	35	70	10x30	50	311.064.11	311.064.12
6,5	35	70	10x30	50	311.065.11	311.065.12
7	35	70	10x30	50	311.070.11	311.070.12
8	35	70	10x30	50	311.080.11	311.080.12
8,2	35	70	10x30	50	311.082.11	311.082.12
9	35	70	10x30	50	311.090.11	311.090.12
9,52	35	70	10x30	50	311.095.11	311.095.12
10	35	70	10x30	50	311.100.11	311.100.12
11	35	70	10x30	10	311.110.11	311.110.12
11,1	35	70	10x30	10	311.111.11	311.111.12
12	35	70	10x30	10	311.120.11	311.120.12
12,7	35	70	10x30	10	311.127.11	311.127.12
13	35	70	10x30	10	311.130.11	311.130.12
14	35	70	10x30	10	311.140.11	311.140.12
15	35	70	10x30	10	311.150.11	311.150.12
16	35	70	10x30	10	311.160.11	311.160.12

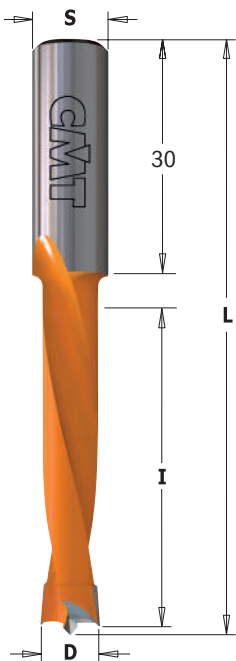
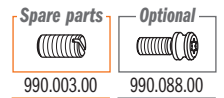

362

HW Z2 V2 RH LH

D mm	I mm	L mm	S mm		ORDER NO. Right-hand rotation	ORDER NO. Left-hand rotation
5	44	77	10x30	50	362.050.11	362.050.12
6	44	77	10x30	50	362.060.11	362.060.12
7	44	77	10x30	50	362.070.11	362.070.12
8	44	77	10x30	50	362.080.11	362.080.12
10	44	77	10x30	50	362.100.11	362.100.12
12	44	77	10x30	10	362.120.11	362.120.12

TECHNICAL DETAILS:

- Premium quality strength steel body.
- High quality HW tip.
- 2 cutting edges [Z2] + 2 negatively ground spurs [V2].
- 2 spiral flutes.
- Balanced centre point.
- Orange or black P.T.F.E. coating.
- Parallel shank with driving flat and length adjusting screw.

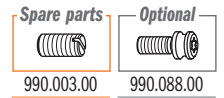

APPLICATION:

for drilling blind holes in solid wood, wood derivatives and laminates.
For use on boring machine equipped with adaptors and/or chucks.

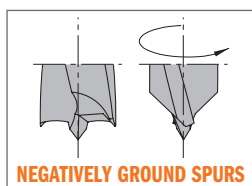

4 Flute Dowel Drills

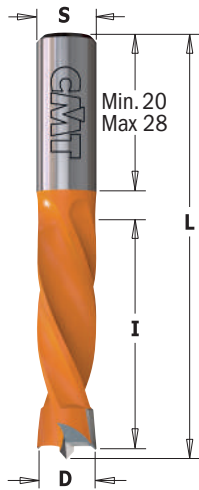

306



D mm	I mm	L mm	S mm		ORDER NO. Right-hand rotation	ORDER NO. Left-hand rotation
• 3	18	55,5	8x28	50	306.030.21	
5	30	55,5	8x20	50	306.050.11	306.050.12
5,55	30	55,5	8x20	50	306.055.11	306.055.12
6	30	55,5	8x20	50	306.060.11	306.060.12
6,35	30	55,5	8x20	50	306.064.11	306.064.12
7	30	55,5	8x20	50	306.070.11	306.070.12
8	30	55,5	8x20	50	306.080.11	306.080.12
9	30	55,5	8x20	50	306.090.11	306.090.12
10	30	55,5	8x20	50	306.100.11	306.100.12
12	30	55,5	8x20	50	306.120.11	306.120.12

• HWM

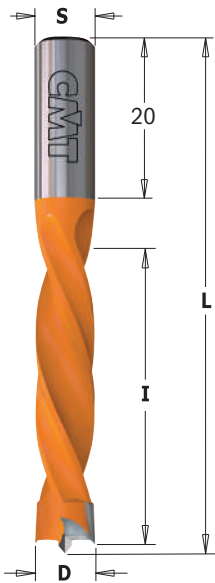
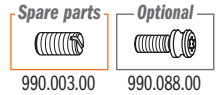

307



D mm	I mm	L mm	S mm		ORDER NO. Right-hand rotation	ORDER NO. Left-hand rotation
5	40	67	8x20	50	307.050.11	307.050.12
5,55	40	67	8x20	50	307.055.11	307.055.12
6	40	67	8x20	50	307.060.11	307.060.12
6,35	40	67	8x20	50	307.064.11	307.064.12
7	40	67	8x20	50	307.070.11	307.070.12
8	40	67	8x20	50	307.080.11	307.080.12
9	40	67	8x20	50	307.090.11	307.090.12
9,52	40	67	8x20	50	307.095.11	307.095.12
10	40	67	8x20	50	307.100.11	307.100.12
12	40	67	8x20	10	307.120.11	307.120.12

TECHNICAL DETAILS:

- Premium quality strength steel body.
- High quality HW tip.
- 2 cutting edges [Z2] + 2 negatively ground spurs [V2].
- 4 spiral flutes.
- Balanced centre point.
- Orange or black P.T.F.E. coating.
- Parallel shank with driving flat and length adjusting screw.

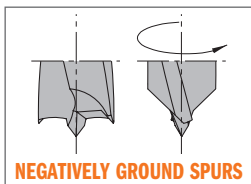
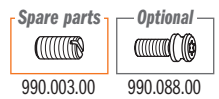

APPLICATION:

for drilling blind holes in solid wood, wood derivatives and laminates.
For use on boring machine equipped with adaptors and/or chucks.

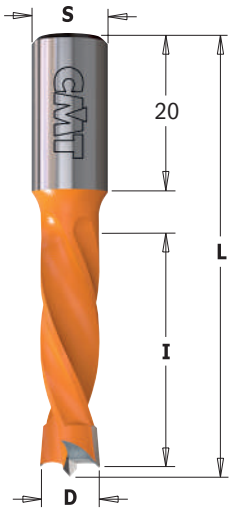

308



D mm	I mm	L mm	S mm		ORDER NO. Right-hand rotation	ORDER NO. Left-hand rotation
4	26	57,5	10x20	50	308.040.11	308.040.12
5	30	57,5	10x20	50	308.050.11	308.050.12
6	30	57,5	10x20	50	308.060.11	308.060.12
6,35	30	57,5	10x20	50	308.064.11	308.064.12
7	30	57,5	10x20	50	308.070.11	308.070.12
8	30	57,5	10x20	50	308.080.11	308.080.12
9	30	57,5	10x20	50	308.090.11	308.090.12
9,52	30	57,5	10x20	50	308.095.11	308.095.12
10	30	57,5	10x20	50	308.100.11	308.100.12
11	30	57,5	10x20	10	308.110.11	308.110.12
12	30	57,5	10x20	10	308.120.11	308.120.12
12,7	30	57,5	10x20	10	308.127.11	308.127.12
13	30	57,5	10x20	10	308.130.11	308.130.12
14	30	57,5	10x20	10	308.140.11	308.140.12
15	30	57,5	10x20	10	308.150.11	308.150.12
16	30	57,5	10x20	10	308.160.11	308.160.12

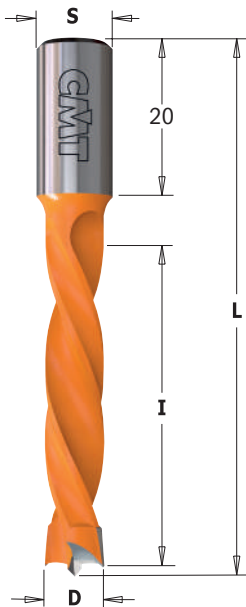
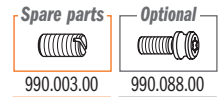

309



D mm	I mm	L mm	S mm		ORDER NO. Right-hand rotation	ORDER NO. Left-hand rotation
4	43	70	10x20	50	309.040.11	309.040.12
5	43	70	10x20	50	309.050.11	309.050.12
6	43	70	10x20	50	309.060.11	309.060.12
6,35	43	70	10x20	50	309.064.11	309.064.12
7	43	70	10x20	50	309.070.11	309.070.12
7,5	43	70	10x20	50	309.075.11	309.075.12
8	43	70	10x20	50	309.080.11	309.080.12
9	43	70	10x20	50	309.090.11	309.090.12
9,52	43	70	10x20	50	309.095.11	309.095.12
10	43	70	10x20	50	309.100.11	309.100.12
11	43	70	10x20	10	309.110.11	309.110.12
12	43	70	10x20	10	309.120.11	309.120.12
12,7	43	70	10x20	10	309.127.11	309.127.12
13	43	70	10x20	10	309.130.11	309.130.12
14	43	70	10x20	10	309.140.11	309.140.12
15	43	70	10x20	10	309.150.11	309.150.12
16	43	70	10x20	10	309.160.11	309.160.12

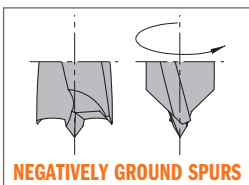
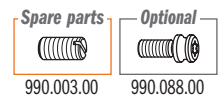

TECHNICAL DETAILS:

- Premium quality strength steel body.
- High quality HW tip.
- 2 cutting edges [Z2] + 2 negatively ground spurs [V2].
- 4 spiral flutes.
- Balanced centre point.
- Orange or black P.T.F.E. coating.
- Parallel shank with driving flat and length adjusting screw.

APPLICATION:

for drilling blind holes in solid wood, wood derivatives and laminates.
For use on boring machine equipped with adaptors and/or chucks.

4 Flute Dowel Drills

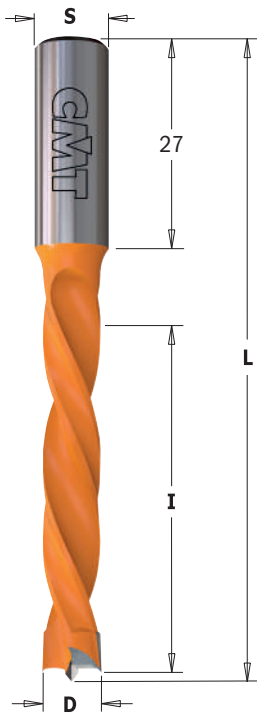

373

HW **Z2** **V2** **RH** **LH**

D mm	I mm	L mm	S mm		ORDER NO. Right-hand rotation	ORDER NO. Left-hand rotation
5	50	85	10x27	50	373.050.11	373.050.12
6	50	85	10x27	50	373.060.11	373.060.12
7	50	85	10x27	50	373.070.11	373.070.12
8	50	85	10x27	50	373.080.11	373.080.12
10	50	85	10x27	50	373.100.11	373.100.12
12	50	85	10x27	10	373.120.11	373.120.12

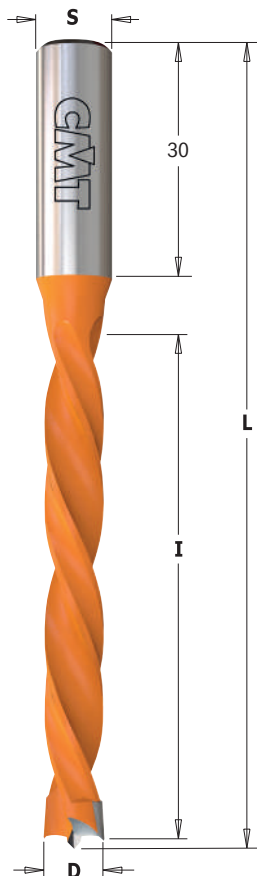
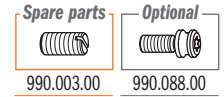

372

HW **Z2** **V2** **RH** **LH**

D mm	I mm	L mm	S mm		ORDER NO. Right-hand rotation	ORDER NO. Left-hand rotation
5	65	105	10x30	10	372.050.11	372.050.12
6	65	105	10x30	10	372.060.11	372.060.12
7	65	105	10x30	10	372.070.11	372.070.12
8	65	105	10x30	10	372.080.11	372.080.12
10	65	105	10x30	10	372.100.11	372.100.12
12	65	105	10x30	10	372.120.11	372.120.12

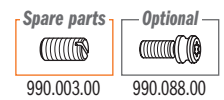

TECHNICAL DETAILS:

- Premium quality strength steel body.
- High quality HW tip.
- 2 cutting edges [Z2] + 2 negatively ground spurs [V2].
- 4 spiral flutes.
- Balanced centre point.
- Orange or black P.T.F.E. coating.
- Parallel shank with driving flat and length adjusting screw.

APPLICATION:

for drilling blind holes in solid wood, wood derivatives and laminates. For use on boring machine equipped with adaptors and/or chucks.

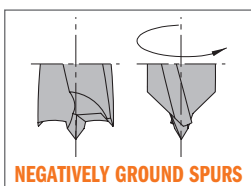

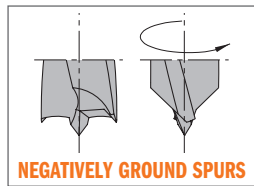
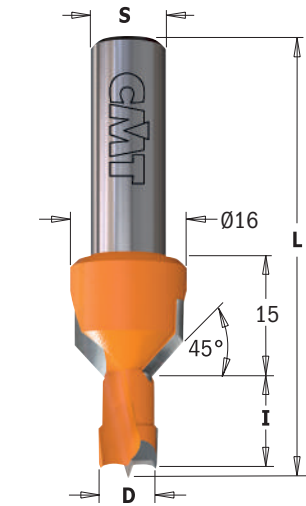

376-377



D mm	I mm	L mm	S mm		ORDER NO. Right-hand rotation	ORDER NO. Left-hand rotation
8	12	57,5	10	10	376.080.11	376.080.12
8	13	57,5	10	10	376.083.11	376.083.12
8	15	57,5	10	10	376.081.11	376.081.12
8	20	57,5	10	10	376.082.11	376.082.12
10	12	57,5	10	10	376.100.11	376.100.12
10	13	57,5	10	10	376.103.11	376.103.12
10	15	57,5	10	10	376.101.11	376.101.12
10	20	57,5	10	10	376.102.11	376.102.12
8	12	70	10	10	377.080.11	377.080.12
8	13	70	10	10	377.083.11	377.083.12
8	15	70	10	10	377.081.11	377.081.12
8	20	70	10	10	377.082.11	377.082.12
10	12	70	10	10	377.100.11	377.100.12
10	13	70	10	10	377.103.11	377.103.12
10	15	70	10	10	377.101.11	377.101.12
10	20	70	10	10	377.102.11	377.102.12

TECHNICAL DETAILS:

- Premium quality strength steel body.
- High quality HW tip.
- 2 cutting edges [Z2] + 2 negatively ground spurs [V2].
- 2 spiral flutes.
- Balanced centre point.
- 2 countersink cutting edges at 45°.
- Orange or black P.T.F.E. coating.
- Parallel shank with driving flat and length adjusting screw.

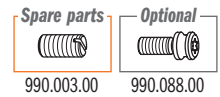

APPLICATION:

for drilling and countersinking in solid wood, wood derivatives and laminates.
For use on boring machine equipped with adaptors and/or chucks.

Dowel Drills for Through Holes with Countersink

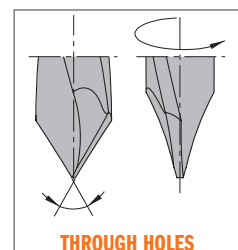
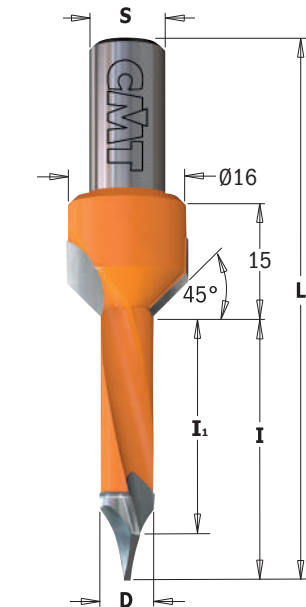

378



D mm	I mm	I ₁ mm	L mm	S mm		ORDER NO. Right-hand rotation	ORDER NO. Left-hand rotation
5	35	31	70	10	10	378.052.11	378.052.12
7	35	29,5	70	10	10	378.072.11	378.072.12
8	35	29	70	10	10	378.082.11	378.082.12
10	35	26,5	70	10	10	378.102.11	378.102.12

TECHNICAL DETAILS:

- Premium quality strength steel body.
- High quality HW tip.
- 2 cutting edges [Z2].
- 2 spiral flutes.
- 2 countersink cutting edges at 45°.
- Orange or black P.T.F.E. coating.
- Parallel shank with driving flat and adjustable screw length.

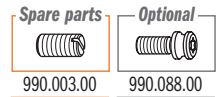

APPLICATION:

for drilling and countersinking in solid wood, wood derivatives and laminates.
For use on boring machine equipped with adaptors and/or chucks.

2 Flute Dowel Drills for Through Holes

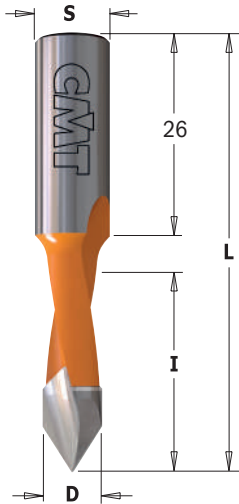

313 FOR PANELS WITH MAXIMUM THICKNESS: 20mm



D mm	I mm	L mm	S mm		ORDER NO. Right-hand rotation	ORDER NO. Left-hand rotation
5	27	57,5	10x26	50	313.050.11	313.050.12
6	27	57,5	10x26	50	313.060.11	313.060.12
8	27	57,5	10x26	50	313.080.11	313.080.12
10	27	57,5	10x26	50	313.100.11	313.100.12

TECHNICAL DETAILS:

- Premium quality strength steel body.
- High quality HW tip.
- 2 precision ground cutting edges [Z2].
- 2 spiral flutes.
- Orange or black P.T.F.E. coating.
- Parallel shank with driving flat and adjustable screw length.

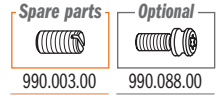

APPLICATION:

for drilling through holes in solid wood, wood derivatives and laminates.
For use on boring machine equipped with adaptors and/or chucks.

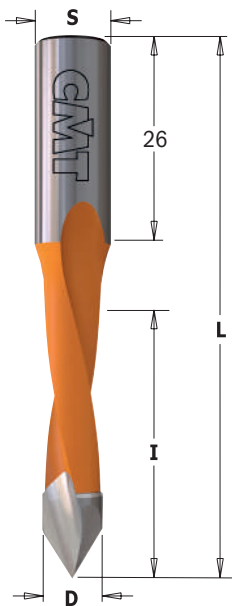

314 FOR PANELS WITH MAXIMUM THICKNESS: 25-30mm



D mm	I mm	L mm	S mm		ORDER NO. Right-hand rotation	ORDER NO. Left-hand rotation
4	30	70	10x26	50	314.040.11	314.040.12
4,76	35	70	10x26	50	314.047.11	314.047.12
5	35	70	10x26	50	314.050.11	314.050.12
5,55	35	70	10x26	50	314.055.11	314.055.12
6	35	70	10x26	50	314.060.11	314.060.12
6,35	35	70	10x26	50	314.064.11	314.064.12
7	35	70	10x26	50	314.070.11	314.070.12
8	35	70	10x26	50	314.080.11	314.080.12
9	35	70	10x26	50	314.090.11	314.090.12
9,52	35	70	10x26	50	314.095.11	314.095.12
10	35	70	10x26	50	314.100.11	314.100.12
12	35	70	10x26	10	314.120.11	314.120.12
12,7	35	70	10x26	10	314.127.11	314.127.12

366 FOR PANELS WITH MAXIMUM THICKNESS: 30-40mm

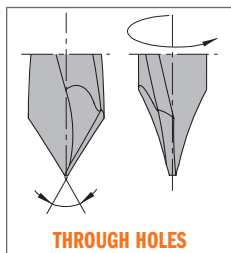

D mm	I mm	L mm	S mm		ORDER NO. Right-hand rotation	ORDER NO. Left-hand rotation
5	44	77	10x26	50	366.050.11	366.050.12
6	44	77	10x26	50	366.060.11	366.060.12
8	44	77	10x26	50	366.080.11	366.080.12
10	44	77	10x26	50	366.100.11	366.100.12
12	44	77	10x26	10	366.120.11	366.120.12

TECHNICAL DETAILS:

- Premium quality strength steel body.
- High quality HW tip.
- 2 cutting edges [Z2].
- 2 spiral flutes.
- Orange or black P.T.F.E. coating.
- Parallel shank with driving flat and adjustable screw length.

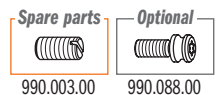

APPLICATION:

for drilling through holes in solid wood, wood derivatives and laminates.
For use on boring machine equipped with adaptors and/or chucks.

2 Flute Dowel Drills for Through Holes

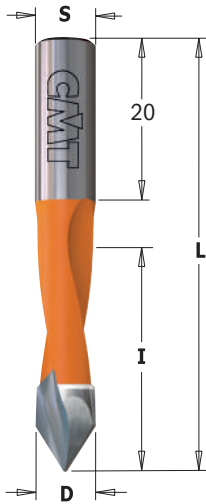

367 FOR PANELS WITH MAXIMUM THICKNESS: 20-25mm

D mm	I mm	L mm	S mm		ORDER NO. Right-hand rotation	ORDER NO. Left-hand rotation
5	30	56	8x20	50	367.050.11	367.050.12
8	30	56	8x20	50	367.080.11	367.080.12

368 FOR PANELS WITH MAXIMUM THICKNESS: 35-40mm

D mm	I mm	L mm	S mm		ORDER NO. Right-hand rotation	ORDER NO. Left-hand rotation
5	43	70	8x20	50	368.050.11	368.050.12
6	43	70	8x20	50	368.060.11	368.060.12
7	43	70	8x20	50	368.070.11	368.070.12
8	43	70	8x20	50	368.080.11	368.080.12

TECHNICAL DETAILS:

- Premium quality strength steel body.
- High quality HW tip.
- 2 cutting edges [Z2].
- 2 spiral flutes.
- Orange or black P.T.F.E. coating.
- Parallel shank with driving flat and adjustable screw length.

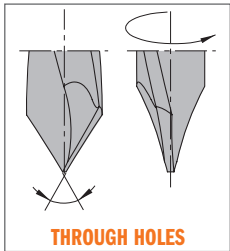
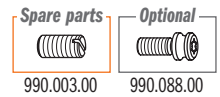

APPLICATION:

for drilling through holes in solid wood, wood derivatives and laminates.
For use on boring machine equipped with adaptors and/or chucks.

4 Flute Dowel Drills for Through Holes

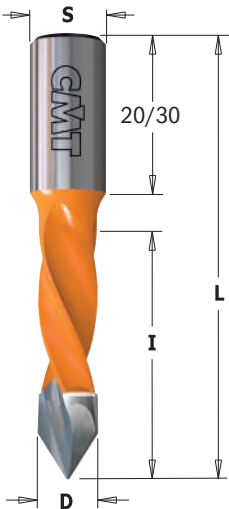

374 FOR PANELS WITH MAXIMUM THICKNESS: 20-25mm

D mm	I mm	L mm	S mm		ORDER NO. Right-hand rotation	ORDER NO. Left-hand rotation
5	30	57,5	10x20	50	374.050.11	374.050.12
8	30	57,5	10x20	50	374.080.11	374.080.12

375 FOR PANELS WITH MAXIMUM THICKNESS: 30-35mm

D mm	I mm	L mm	S mm		ORDER NO. Right-hand rotation	ORDER NO. Left-hand rotation
4	40	70	10x20	50	375.040.11	375.040.12
5	40	70	10x20	50	375.050.11	375.050.12
6	40	70	10x20	50	375.060.11	375.060.12
7	40	70	10x20	50	375.070.11	375.070.12
8	40	70	10x20	50	375.080.11	375.080.12
9	40	70	10x20	50	375.090.11	375.090.12
10	40	70	10x20	50	375.100.11	375.100.12

381 FOR PANELS WITH MAXIMUM THICKNESS: 60-65mm

D mm	I mm	L mm	S mm		ORDER NO. Right-hand rotation	ORDER NO. Left-hand rotation
5	70	115	10x30	10	381.050.11	381.050.12
6	70	115	10x30	10	381.060.11	381.060.12
8	70	115	10x30	10	381.080.11	381.080.12
10	70	115	10x30	10	381.100.11	381.100.12

TECHNICAL DETAILS:

- Premium quality strength steel body.
- High quality HW tip.
- 2 cutting edges [Z2].
- 4 spiral flutes.
- Orange or black P.T.F.E. coating.
- Parallel shank with driving flat and adjustable screw length.

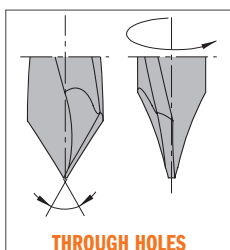
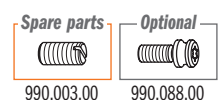

APPLICATION:

for drilling through holes in solid wood, wood derivatives and laminates.
For use on boring machine equipped with adaptors and/or chucks.

Countersinks for 2 Flutes Dowel Drills

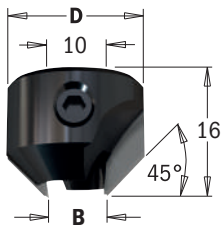

315

HW Z2 RH LH

B mm	D mm		ORDER NO. Right-hand rotation	ORDER NO. Left-hand rotation
5 ~ 10	20	10	315.200.11	315.200.12
11 ~ 12	22	10	315.220.11	315.220.12

Spare parts	
990.006.00	991.062.00

TECHNICAL DETAILS:

- Strength steel.
- Countersink: 2 carbide tipped cutting edges [Z2] at 45°.
- Direct clamp on the shank of the drills.
- Fastening screw for quick and easy drill bit change HSS drill bit.

APPLICATION:

for chamfering in solid wood, wood derivatives and laminates.

315 ASSEMBLY ILLUSTRATION



Countersinks for 4 Flutes Dowel Drills

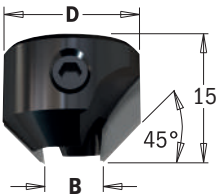

316

HW Z2 RH LH

B mm	D mm		ORDER NO. Right-hand rotation	ORDER NO. Left-hand rotation
4	16	10	316.040.11	316.040.12
5	16	10	316.050.11	316.050.12
6	16	10	316.060.11	316.060.12
7	16	10	316.070.11	316.070.12
8	18	10	316.080.11	316.080.12
9	18	10	316.090.11	316.090.12
10	20	10	316.100.11	316.100.12
12	20	10	316.120.11	316.120.12

Spare parts	
990.002.00	991.062.00

TECHNICAL DETAILS:

- Strength steel.
- Countersink: 2 carbide tipped cutting edges [Z2] at 45°.
- Direct clamp on the shank of the drills.
- Fastening screw for quick and easy drill bit change HSS drill bit.

APPLICATION:

for chamfering in solid wood, wood derivatives and laminates.

316 ASSEMBLY ILLUSTRATION



90° Solid Carbide Countersink with Driving Flat

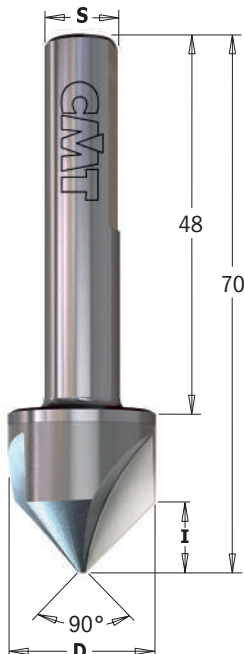

521

HWM Z3 RH

D mm	I mm	L mm	S mm		ORDER NO. Right-hand rotation
19,5	9	70	10x48	10	521.002.21

TECHNICAL DETAILS:

- Premium quality strength steel body.
- High quality HW tip.
- 3 cutting edges [Z3] at 90°.
- Parallel shank with driving flat.

APPLICATION:

for making 90° countersinks for the insertion of screws that sit flush with the surface. Suitable for wood, wood-based, non-ferrous materials and metal.

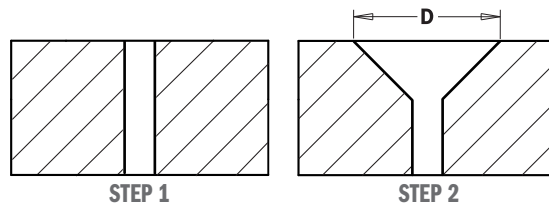

Spare parts
990.003.00

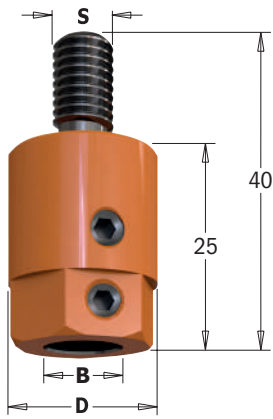





301

RH LH

B mm	D mm	S mm		ORDER NO. Right-hand rotation	ORDER NO. Left-hand rotation
8	16	M8		301.080.01	301.080.02
10	19,5	M8		301.000.01	301.000.02

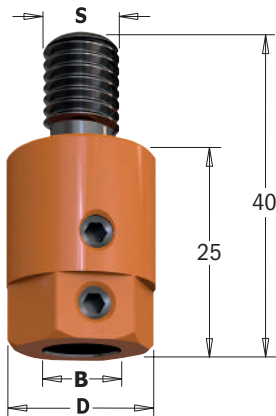

FOR USE ON THE FOLLOWING MACHINES:
NOTTMEYER® (older models).

Spare parts	
	
990.006.00	991.062.00





302

RH LH

B mm	D mm	S mm		ORDER NO. Right-hand rotation	ORDER NO. Left-hand rotation
8	16	M10		302.080.01	302.080.02
10	19,5	M10		302.000.01	302.000.02

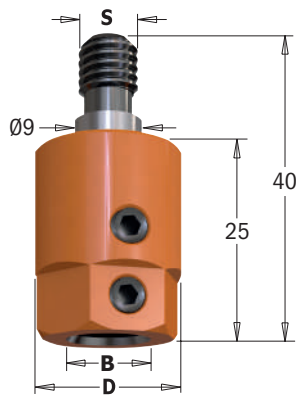

FOR USE ON THE FOLLOWING MACHINES:
AYEN®, HOLZMA®, KNOEVENAGEL®, MAYER®, TORWEGGE®.

Spare parts	
	
990.006.00	991.062.00





358

RH LH

B mm	D mm	S mm		ORDER NO. Right-hand rotation	ORDER NO. Left-hand rotation
8	16	M8/9		358.080.01	358.080.02
10	19,5	M8/9		358.000.01	358.000.02

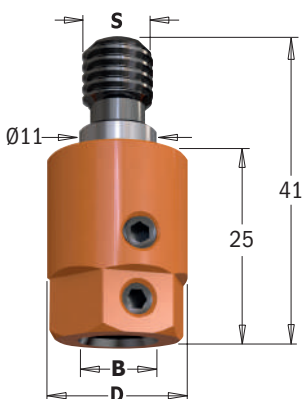

FOR USE ON THE FOLLOWING MACHINES:
MASTERWOOD® (Zangheri & Boschetti).
MORBIDELLI®, NOTTMEYER® (new design).

Spare parts	
	
990.006.00	991.062.00





305

RH LH

B mm	D mm	S mm		ORDER NO. Right-hand rotation	ORDER NO. Left-hand rotation
8	16	M10/11		305.080.01	305.080.02
10	19,5	M10/11		305.000.01	305.000.02

FOR USE ON THE FOLLOWING MACHINES:
BIESSE® (older models).
MASTERWOOD® (Zangheri & Boschetti).
MORBIDELLI®, TORWEGGE®, VITAP® (new design).
WEEKE®.

Spare parts	
	
990.006.00	991.062.00

Adaptors

RH LH

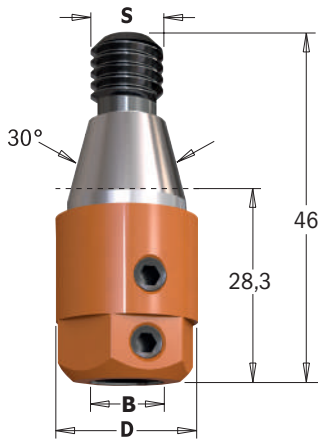

303

B mm	D mm	S mm		ORDER NO. Right-hand rotation	ORDER NO. Left-hand rotation
8	16	M10/30°	10	303.080.01	303.080.02
10	19,5	M10/30°	10	303.000.01	303.000.02

FOR USE ON THE FOLLOWING MACHINES:

ALBERTI® (older models).
BALESTRINI®, BILEK®, BUSELLATO® (older models).
SCHLEICHER®, VITAP® (older models).

Spare parts

990.006.00	991.062.00



359

B mm	D mm	S mm		ORDER NO. Right-hand rotation	ORDER NO. Left-hand rotation
10	19,5	M10	10	359.000.01	359.000.02

FOR USE ON THE FOLLOWING MACHINES:

SCHEER®.

Spare parts

990.006.00	991.062.00

RH LH



359

B mm	D mm	S mm		ORDER NO. Right-hand rotation	
10	19,5	10x35	10	359.100.00	

For use on boring machine centres.

Spare parts

990.006.00	991.062.00

RH



360.001

B mm	d mm	D mm		ORDER NO. Right-hand rotation	ORDER NO. Left-hand rotation
10	20	15	10	360.001.01	360.001.02

FOR USE ON THE FOLLOWING MACHINES:

BIESSE® machines with quick drill change chuck.

Spare parts

990.007.00	991.067.00

RH LH



360.101



B mm	d mm	D mm		ORDER NO. Right-hand & Left-hand rotation
10	17,5	18	10	360.101.00

FOR USE ON THE FOLLOWING MACHINES:
VITAP®.

Spare parts	
990.015.00	991.062.00



360.201



B mm	d mm	D mm		ORDER NO. Right-hand & Left-hand rotation
10	19,5	20	10	360.201.00

FOR USE ON THE FOLLOWING MACHINES:
MORBIDELLI®.

Spare parts	
990.009.00	991.067.00



360.301



B mm	d mm	D mm		ORDER NO. Right-hand & Left-hand rotation
10	19,5	20	10	360.301.00

FOR USE ON THE FOLLOWING MACHINES:
MASTERWOOD®, MAGGI®, FELDER®, GRIGGIO®.

Spare parts	
990.015.00	991.062.00



360.401



B mm	d mm	D mm		ORDER NO. Right-hand & Left-hand rotation
10	20	17	10	360.401.00

FOR USE ON THE FOLLOWING MACHINES:
WEEKE®.





Spare parts	
990.009.00	991.067.00



990.088



DESCRIPTION		ORDER NO. Right-hand & Left-hand rotation
Retaining screw for WEEKE® machines	10	990.088.00

LINE	DP	XTREME	INDUSTRIAL with Chipbreaker	INDUSTRIAL
PERFORMANCE	★★★★★	★★★★★	★★★	★★★
BIT				
DESCRIPTION	Designed for heavy duty drilling in Large-Scale Industrial Manufacturing ensuring high impact resistance, greater durability and good chip evacuation thanks to the chipbreaker.	Designed for heavy duty drilling in Large-Scale Industrial Manufacturing ensuring high impact resistance and greater durability.	Designed for medium to light-duty drilling in medium to small-scale industrial manufacturing ensuring good chip evacuation thanks to the chipbreaker.	Designed for medium to light-duty drilling in medium to small-scale industrial manufacturing ensuring rigorous impact resistance and good durability.
USER	LARGE-SCALE INDUSTRIAL MANUFACTURING	LARGE-SCALE INDUSTRIAL MANUFACTURING	MEDIUM-SCALE TO SMALL-SCALE INDUSTRIAL MANUFACTURING	MEDIUM-SCALE TO SMALL-SCALE INDUSTRIAL MANUFACTURING
RECOMMENDED USE	INDUSTRIAL PRODUCTION	INDUSTRIAL PRODUCTION	INDUSTRIAL/REMODELER	INDUSTRIAL/REMODELER
MATERIALS	Ideal for chipboard, MDF, HDF, laminates and abrasive panels in which long service life is imperative.	Ideal for chipboard, MDF, HDF and laminates. Non-protruding center-point and spurs make this tool perfect for low-thickness panels.	Excellent for solid wood. Good for chipboard, MDF, HDF and laminates.	Excellent for solid wood. Good for chipboard, MDF, HDF and laminates.
SHARPENING & MAINTENANCE	NEGATIVELY GROUND SPURS: standard design HW head featuring precision balanced centre point. 2 HW precision ground cutting edges and 2 negatively ground spurs.	XTREME FLAT SHARPENING: flat edges with reinforced spurs allow perfect finishing and prolonged drilling at high-speed cutting feed.	NEGATIVELY GROUND SPURS: standard design HW head featuring precision balanced centre point. 2 HW precision ground cutting edges with chipbreaker and 2 negatively ground spurs.	NEGATIVELY GROUND SPURS: standard design HW head featuring precision balanced centre point. 2 HW precision ground cutting edges with chipbreaker and 2 negatively ground spurs.
DIAMOND/CARBIDE	The special polycrystalline diamond formula increases tool life up to 20 times longer than HW hinge bits. Good number of resharpenings guaranteed. The best quality/price ratio	INDUSTRIAL CHROMIUM MICROGRAIN CARBIDE Special chromium enhanced carbide produces clean bores with no rough edges even in corners. Chromium Micrograin Carbide guarantees exceptional resistance to fatigue and abrasion for longer lifetime.	INDUSTRIAL GRADE CARBIDE Fine and medium grain carbide grade guarantee reliable prolonged use.	INDUSTRIAL GRADE CARBIDE Fine and medium grain carbide grade guarantee reliable prolonged use.
COATING	High-quality nickel-plated with anti-friction and anti-corrosion properties.	C.M.T. P.T.F.E. coating provides a non-stick surface preventing resin, glue or sludge residue accumulation on the bit body. Baked at 420°, this unique industrial material is specifically designed to fit woodworking tool requirements.	C.M.T. P.T.F.E. coating provides a non-stick surface preventing resin, glue or sludge residue accumulation on the bit body. Baked at 420°, this unique industrial material is specifically designed to fit woodworking tool requirements.	C.M.T. P.T.F.E. coating provides a non-stick surface preventing resin, glue or sludge residue accumulation on the bit body. Baked at 420°, this unique industrial material is specifically designed to fit woodworking tool requirements.
PRICE RANGE	HIGH	MEDIUM/HIGH	MEDIUM	MEDIUM

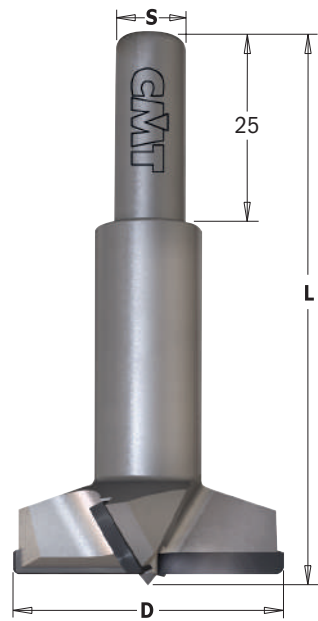

20X
LONGER LIFE
THAN CARBIDE

20X
LONGER LIFE
THAN CARBIDE

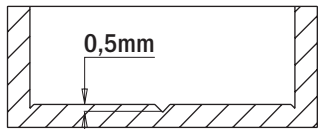

New construction with 0,5mm centre point

317

PCD DP **LONG LIFE** Z2 V2 RH LH

D mm	L mm	S mm		ORDER NO. Right-hand rotation	ORDER NO. Left-hand rotation
15	57,5	10x25	10	317.150.61	317.150.62
35	57,5	10x25	10	317.350.61	317.350.62

369

D mm	L mm	S mm		ORDER NO. Right-hand rotation	ORDER NO. Left-hand rotation
15	70	10x25	10	369.150.61	369.150.62
16	70	10x25	10	369.160.61	369.160.62
20	70	10x25	10	369.200.61	369.200.62
25	70	10x25	10	369.250.61	369.250.62
26	70	10x25	10	369.260.61	369.260.62
35	70	10x25	10	369.350.61	369.350.62

TECHNICAL DETAILS:

- Premium quality strength steel.
- DP balanced centre point 0,5mm.
- 2 DP ground cutting edges [Z2] + 2 DP negatively ground spurs [V2].
- Parallel shank with driving flat and length adjusting screw.

Spare parts 990.003.00 Optional 990.088.00

APPLICATION:

use for drilling accurate and clean-cut blind holes in wood composites, plastic and laminated materials. **Ideal for hinges.** For use on boring machine equipped with adaptors and/or chucks. Boring performance 20 times longer than HW materials.

REMARK: special dimensions available on request.

Hinge Boring Bits

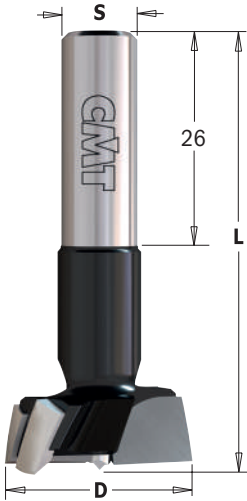

XTREME SHARPENING CURVED SPURS

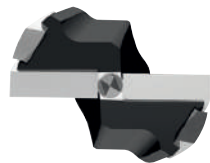

New construction with 0,8mm centre point

317 XTREME

HW Z2 V2 RH LH

D mm	L mm	S mm		ORDER NO. Right-hand rotation	ORDER NO. Left-hand rotation
15	57,5	10x26	10	317.150.41	317.150.42
18	57,5	10x26	10	317.180.41	317.180.42
20	57,5	10x26	10	317.200.41	317.200.42
25	57,5	10x26	10	317.250.41	317.250.42
26	57,5	10x26	10	317.260.41	317.260.42
35*	57,5	10x26	10	317.350.41	317.350.42

369 XTREME

HW Z2 V2 RH LH

D mm	L mm	S mm		ORDER NO. Right-hand rotation	ORDER NO. Left-hand rotation
15	70	10x26	10	369.150.41	369.150.42
18	70	10x26	10	369.180.41	369.180.42
20	70	10x26	10	369.200.41	369.200.42
25	70	10x26	10	369.250.41	369.250.42
26	70	10x26	10	369.260.41	369.260.42
35*	70	10x26	10	369.350.41	369.350.42

*with chipbreaker

TECHNICAL DETAILS:

- Premium quality strength steel.
- Balanced centre point 0,8mm.
- 2 ground cutting edges [Z2] + 2 negatively ground spurs [V2].
- Orange or black P.T.F.E. coating.
- Parallel shank with driving flat and length adjusting screw.

Spare parts 990.003.00 Optional 990.088.00

APPLICATION:

use for drilling accurate and clean-cut blind holes in wood composites, plastic and laminated materials. **Ideal for hinges.** For use on boring machine equipped with adaptors and/or chucks.

Hinge Boring Bits with Chipbreaker

HW Z2R V2 RH LH

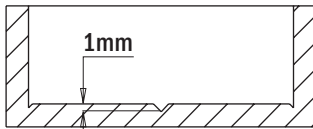

New construction with 1mm centre point

317C

D mm	L mm	S mm			ORDER NO. Right-hand rotation	ORDER NO. Left-hand rotation
35	57,5	10x26		10	317.350.11C	317.350.12C
40	57,5	10x26		10	317.400.11C	317.400.12C
45	57,5	10x26		10	317.450.11C	317.450.12C

369C

HW Z2R V2 RH LH

D mm	L mm	S mm			ORDER NO. Right-hand rotation	ORDER NO. Left-hand rotation
35	70	10x26		10	369.350.11C	369.350.12C
40	70	10x26		10	369.400.11C	369.400.12C
45	70	10x26		10	369.450.11C	369.450.12C

TECHNICAL DETAILS:

- Premium quality strength steel.
- Balanced centre point 1mm.
- 2 ground cutting edges with chipbreaker [Z2R] + 2 negatively ground spurs [V2].
- Orange or black P.T.F.E. coating.
- Parallel shank with driving flat and length adjusting screw.

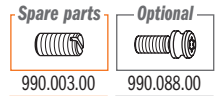

APPLICATION:

use for drilling accurate and clean-cut blind holes in wood composites, plastic and laminated materials.
Ideal for hinges. For use on boring machine equipped with adaptors and/or chucks.

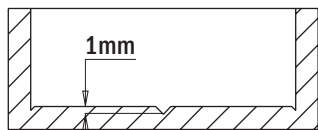
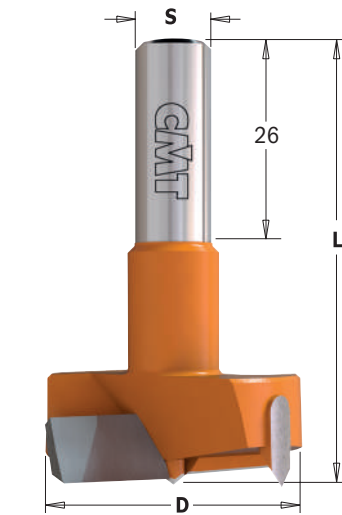

New construction with 1mm centre point

317



D mm	L mm	S mm		ORDER NO. Right-hand rotation	ORDER NO. Left-hand rotation
14	57,5	10x26	10	317.140.11	317.140.12
15	57,5	10x26	10	317.150.11	317.150.12
16	57,5	10x26	10	317.160.11	317.160.12
17	57,5	10x26	10	317.170.11	317.170.12
18	57,5	10x26	10	317.180.11	317.180.12
19	57,5	10x26	10	317.190.11	317.190.12
20	57,5	10x26	10	317.200.11	317.200.12
22	57,5	10x26	10	317.220.11	317.220.12
24	57,5	10x26	10	317.240.11	317.240.12
25	57,5	10x26	10	317.250.11	317.250.12
26	57,5	10x26	10	317.260.11	317.260.12
28	57,5	10x26	10	317.280.11	317.280.12
30	57,5	10x26	10	317.300.11	317.300.12
32	57,5	10x26	10	317.320.11	317.320.12
34	57,5	10x26	10	317.340.11	317.340.12
35	57,5	10x26	10	317.350.11	317.350.12
38	57,5	10x26	10	317.380.11	317.380.12
40	57,5	10x26	10	317.400.11	317.400.12
42	57,5	10x26	10	317.420.11	317.420.12
45	57,5	10x26	10	317.450.11	317.450.12
50	57,5	10x26	10	317.500.11	317.500.12
55	57,5	10x26	10	317.550.11	317.550.12
60	57,5	10x26	10	317.600.11	317.600.12

TECHNICAL DETAILS:

- Premium quality strength steel.
- Balanced centre point 1mm.
- 2 ground cutting edges [Z2]
- + 2 negatively ground spurs [V2].
- Orange or black P.T.F.E. coating.
- Parallel shank with driving flat and length adjusting screw.

APPLICATION:

use for drilling accurate and clean-cut blind holes in wood composites, plastic and laminated materials.

Ideal for hinges. For use on boring machine equipped with adaptors and/or chucks.

369



D mm	L mm	S mm		ORDER NO. Right-hand rotation	ORDER NO. Left-hand rotation
14	70	10x26	10	369.140.11	369.140.12
15	70	10x26	10	369.150.11	369.150.12
16	70	10x26	10	369.160.11	369.160.12
18	70	10x26	10	369.180.11	369.180.12
20	70	10x26	10	369.200.11	369.200.12
22	70	10x26	10	369.220.11	369.220.12
25	70	10x26	10	369.250.11	369.250.12
26	70	10x26	10	369.260.11	369.260.12
30	70	10x26	10	369.300.11	369.300.12
35	70	10x26	10	369.350.11	369.350.12
40	70	10x26	10	369.400.11	369.400.12
45	70	10x26	10	369.450.11	369.450.12
50	70	10x26	10	369.500.11	369.500.12
55	70	10x26	10	369.550.11	369.550.12
60	70	10x26	10	369.600.11	369.600.12

370



D mm	L mm	S mm		ORDER NO. Right-hand rotation	ORDER NO. Left-hand rotation
18	77	10x30	10	370.180.11	370.180.12
20	77	10x30	10	370.200.11	370.200.12
25	77	10x30	10	370.250.11	370.250.12
30	77	10x30	10	370.300.11	370.300.12
35	77	10x30	10	370.350.11	370.350.12

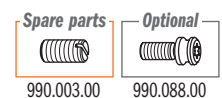

Dowel Drills with Threaded Shank with Countersink

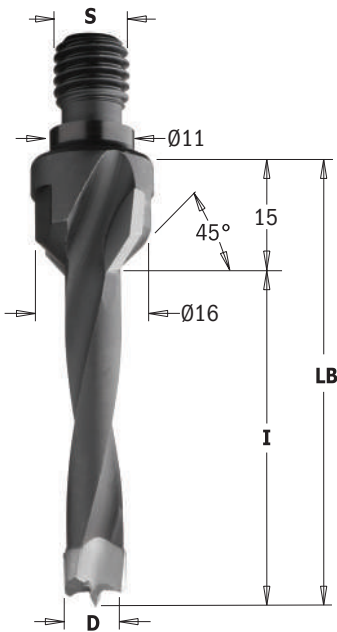

325-327-329-330

HW **Z2** **V2** **RH** **LH**

D mm	I mm	LB mm	S mm		ORDER NO. Right-hand rotation	ORDER NO. Left-hand rotation
5	20	35	M10/11x4	10	325.050.11	325.050.12
6	20	35	M10/11x4	10	325.060.11	325.060.12
8	20	35	M10/11x4	10	325.080.11	325.080.12
10	20	35	M10/11x4	10	325.100.11	325.100.12
12	20	35	M10/11x4	10	325.120.11	325.120.12
5	30	45	M10/11x4	10	327.050.11	327.050.12
6	30	45	M10/11x4	10	327.060.11	327.060.12
8	30	45	M10/11x4	10	327.080.11	327.080.12
10	30	45	M10/11x4	10	327.100.11	327.100.12
12	30	45	M10/11x4	10	327.120.11	327.120.12
5	40	55	M10/11x4	10	329.050.11	329.050.12
6	40	55	M10/11x4	10	329.060.11	329.060.12
8	40	55	M10/11x4	10	329.080.11	329.080.12
10	40	55	M10/11x4	10	329.100.11	329.100.12
12	40	55	M10/11x4	10	329.120.11	329.120.12
5	50	65	M10/11x4	10	330.050.11	330.050.12
6	50	65	M10/11x4	10	330.060.11	330.060.12
8	50	65	M10/11x4	10	330.080.11	330.080.12
10	50	65	M10/11x4	10	330.100.11	330.100.12
12	50	65	M10/11x4	10	330.120.11	330.120.12

TECHNICAL DETAILS:

- Premium quality strength steel body.
- High quality HW tip.
- 2 cutting edges [Z2] + 2 negatively ground spurs [V2].
- 2 spiral flutes.
- Balanced centre point.
- 2 countersink cutting edges at 45°.
- Orange or black P.T.F.E. coating.

APPLICATION:

for drilling blind holes in solid wood, wood composites, plastic and laminated materials. For use on boring machines equipped with chucks.

Dowel Drills with Threaded Shank without Countersink



338-339-340

HW **Z2** **V2** **RH** **LH**

D mm	I mm	LB mm	S mm		ORDER NO. Right-hand rotation	ORDER NO. Left-hand rotation
5	30	45	M10/11x4	10	338.050.11	338.050.12
6	30	45	M10/11x4	10	338.060.11	338.060.12
8	30	45	M10/11x4	10	338.080.11	338.080.12
10	30	45	M10/11x4	10	338.100.11	338.100.12
12	30	45	M10/11x4	10	338.120.11	338.120.12
5	40	55	M10/11x4	10	339.050.11	339.050.12
6	40	55	M10/11x4	10	339.060.11	339.060.12
8	40	55	M10/11x4	10	339.080.11	339.080.12
10	40	55	M10/11x4	10	339.100.11	339.100.12
12	40	55	M10/11x4	10	339.120.11	339.120.12
5	50	65	M10/11x4	10	340.050.11	340.050.12
6	50	65	M10/11x4	10	340.060.11	340.060.12
8	50	65	M10/11x4	10	340.080.11	340.080.12
10	50	65	M10/11x4	10	340.100.11	340.100.12
12	50	65	M10/11x4	10	340.120.11	340.120.12

TECHNICAL DETAILS:

- Premium quality strength steel body.
- High quality HW tip.
- 2 cutting edges [Z2] + 2 negatively ground spurs [V2].
- 4 spiral flutes.
- Balanced centre point.
- Orange or black P.T.F.E. coating.

APPLICATION:

for drilling blind holes in solid wood, wood composites, plastic and laminated materials. For use on boring machines equipped with chucks.

Dowel Drills with Threaded Shank



344



D mm	I mm	LB mm	S mm		ORDER NO. Right-hand rotation	ORDER NO. Left-hand rotation
5	43	63	M8	10	344.050.11	344.050.12
6	43	63	M8	10	344.060.11	344.060.12
8	43	63	M8	10	344.080.11	344.080.12
10	43	63	M8	10	344.100.11	344.100.12
12	43	63	M8	10	344.120.11	344.120.12

FOR USE ON THE FOLLOWING MACHINES:

NOTTMEYER® (older models)

346



D mm	I mm	LB mm	S mm		ORDER NO. Right-hand rotation	ORDER NO. Left-hand rotation
5	43	63	M10	10	346.050.11	346.050.12
6	43	63	M10	10	346.060.11	346.060.12
8	43	63	M10	10	346.080.11	346.080.12
10	43	63	M10	10	346.100.11	346.100.12
12	43	63	M10	10	346.120.11	346.120.12

FOR USE ON THE FOLLOWING MACHINES:

AYEN®, HOLZMA®, KNOEVENAGEL®, MAYER®, TORWEGGE®.

TECHNICAL DETAILS:

- Premium quality strength steel body.
- High quality HW tip.
- 2 cutting edges [Z2] + 2 negatively ground spurs [V2].
- 4 spiral flutes.
- Balanced centre point.
- Orange or black P.T.F.E. coating.

APPLICATION:

for drilling blind holes in solid wood, wood composites, plastic and laminated materials. For use on boring machines equipped with chucks.

Dowel Drills with Threaded Shank



352-353



D mm	I mm	LB mm	S mm		ORDER NO. Right-hand rotation	ORDER NO. Left-hand rotation
5	30	45	M8/9	10	352.050.11	352.050.12
6	30	45	M8/9	10	352.060.11	352.060.12
8	30	45	M8/9	10	352.080.11	352.080.12
10	30	45	M8/9	10	352.100.11	352.100.12
12	30	45	M8/9	10	352.120.11	352.120.12
5	40	55	M8/9	10	353.050.11	353.050.12
6	40	55	M8/9	10	353.060.11	353.060.12
8	40	55	M8/9	10	353.080.11	353.080.12
10	40	55	M8/9	10	353.100.11	353.100.12
12	40	55	M8/9	10	353.120.11	353.120.12

FOR USE ON THE FOLLOWING MACHINES:

MASTERWOOD® (Zangheri & Boschetti), MORBIDELLI®, NOTTMEYER® (new design).

TECHNICAL DETAILS:

- Premium quality strength steel body.
- High quality HW tip.
- 2 cutting edges [Z2] + 2 negatively ground spurs [V2].
- 4 spiral flutes.
- Balanced centre point.
- Orange or black P.T.F.E. coating.

APPLICATION:

for drilling blind holes in solid wood, wood composites, plastic and laminated materials. For use on boring machines equipped with chucks.

Dowel Drills with Threaded Shank with Countersink

HW Z2 V2 RH LH

332-334-336-337

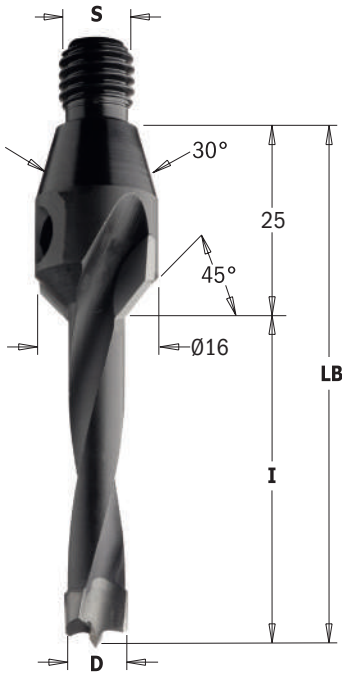

D mm	I mm	LB mm	S mm		ORDER NO. Right-hand rotation	ORDER NO. Left-hand rotation
□ 5	20	45	M10/30°	10	332.050.11	332.050.12
□ 6	20	45	M10/30°	10	332.060.11	332.060.12
□ 8	20	45	M10/30°	10	332.080.11	332.080.12
□ 10	20	45	M10/30°	10	332.100.11	332.100.12
□ 12	20	45	M10/30°	10	332.120.11	332.120.12
□ 5	30	55	M10/30°	10	334.050.11	334.050.12
□ 6	30	55	M10/30°	10	334.060.11	334.060.12
□ 8	30	55	M10/30°	10	334.080.11	334.080.12
□ 10	30	55	M10/30°	10	334.100.11	334.100.12
□ 12	30	55	M10/30°	10	334.120.11	334.120.12
□ 5	40	65	M10/30°	10	336.050.11	336.050.12
□ 6	40	65	M10/30°	10	336.060.11	336.060.12
□ 8	40	65	M10/30°	10	336.080.11	336.080.12
□ 10	40	65	M10/30°	10	336.100.11	336.100.12
□ 12	40	65	M10/30°	10	336.120.11	336.120.12
□ 5	50	75	M10/30°	10	337.050.11	337.050.12
□ 6	50	75	M10/30°	10	337.060.11	337.060.12
□ 8	50	75	M10/30°	10	337.080.11	337.080.12
□ 10	50	75	M10/30°	10	337.100.11	337.100.12
□ 12	50	75	M10/30°	10	337.120.11	337.120.12

□ On request

TECHNICAL DETAILS:

- Premium quality strength steel body.
- High quality HW tip.
- 2 cutting edges [Z2] + 2 negatively ground spurs [V2].
- 2 spiral flutes.
- Balanced centre point.
- 2 countersink cutting edges at 45°.
- Orange or black P.T.F.E. coating.

APPLICATION:

for drilling blind holes in solid wood, wood composites, plastic and laminated materials. For use on boring machines equipped with chucks.

Dowel Drills with Threaded Shank without Countersink

HW Z2 V2 RH LH

341-342-343



D mm	I mm	LB mm	S mm		ORDER NO. Right-hand rotation	ORDER NO. Left-hand rotation
□ 5	30	55	M10/30°	10	341.050.11	341.050.12
□ 6	30	55	M10/30°	10	341.060.11	341.060.12
□ 8	30	55	M10/30°	10	341.080.11	341.080.12
□ 10	30	55	M10/30°	10	341.100.11	341.100.12
□ 12	30	55	M10/30°	10	341.120.11	341.120.12
□ 5	40	65	M10/30°	10	342.050.11	342.050.12
□ 6	40	65	M10/30°	10	342.060.11	342.060.12
□ 8	40	65	M10/30°	10	342.080.11	342.080.12
□ 10	40	65	M10/30°	10	342.100.11	342.100.12
□ 12	40	65	M10/30°	10	342.120.11	342.120.12
□ 5	50	75	M10/30°	10	343.050.11	343.050.12
□ 6	50	75	M10/30°	10	343.060.11	343.060.12
□ 8	50	75	M10/30°	10	343.080.11	343.080.12
□ 10	50	75	M10/30°	10	343.100.11	343.100.12
□ 12	50	75	M10/30°	20	343.120.11	343.120.12

□ On request

TECHNICAL DETAILS:

- Premium quality strength steel body.
- High quality HW tip.
- 2 cutting edges [Z2] + 2 negatively ground spurs [V2].
- 4 spiral flutes.
- Balanced centre point.
- Orange or black P.T.F.E. coating.

APPLICATION:

for drilling blind holes in solid wood, wood composites, plastic and laminated materials. For use on boring machines equipped with chucks.

BITS FOR HAND POWER TOOLS



PRODUCTS	PAGE
Adaptors & Extension	356-357
Interchangeable Boring Bits	357
Boring Bits	358~361
Mortise Chisel & Bit Sets	361
Plug Cutters & Sets	362-363
Forstner Bits	364
Rosette Cutters	365
Bits for MAFELL® & FESTOOL® Machines	366
Auger	367
Brad Point Bits & Sets	367~369
Drill Bits for ANUBA® Hinges	369
Countersinks & Drills	370~373



Adaptors

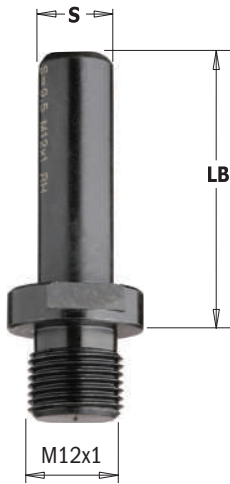

509-532-533 ...WITH PARALLEL SHANK FOR INTERCHANGEABLE BITS

RH LH

S mm	LB mm			ORDER NO. Right-hand rotation	ORDER NO. Left-hand rotation
8x30	35		10	532.080.01	
9,5x30	35		10	532.095.01	
10x50	60		1	533.100.01	
12x30	35		10	532.120.01	
13x50	100		1	509.130.01	509.130.02
16x50	100		1	509.160.01	509.160.02

For use with the following parts: **501 HW**

TECHNICAL DETAILS:

- Strength steel.
- Precision grinding on all contact surfaces.

APPLICATION:

for use on boring machines equipped with adaptors and/or chucks.

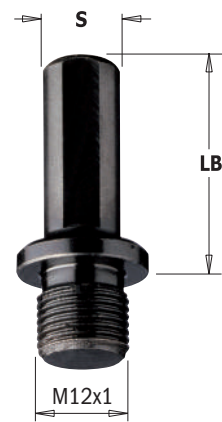

511 ...WITH PARALLEL SHANK FOR QUICK CHANGE DRILLS

RH LH

S mm	LB mm		ORDER NO. Right-hand rotation	ORDER NO. Left-hand rotation
10x20 (with driving flat and screw)	27	10	511.270.01	511.270.02
10x35 (with driving flat and screw)	40	10	511.400.01	511.400.02

For use with the following parts: **501 HW**

TECHNICAL DETAILS:

- Strength steel.
- Precision grinding on all contact surfaces.

APPLICATION:

for use on boring machines equipped with adaptors and/or chucks.

Spare parts

990.003.00



506

RH LH

S mm	LB mm		ORDER NO. Right-hand rotation	ORDER NO. Left-hand rotation
M10/11x4	15	1	506.150.01	506.150.02
M10/11x4	25	1	506.250.01	506.250.02
M10/11x4	35	1	506.350.01	506.350.02

For use with the following parts: **501 HW**

TECHNICAL DETAILS:

- Strength steel.
- Precision grinding on all contact surfaces.

APPLICATION:

for use on boring machines equipped with adaptors and/or chucks.



503

RH LH

S mm	LB mm		ORDER NO. Right-hand rotation	ORDER NO. Left-hand rotation
M10/30°	25	1	503.250.01	503.250.02
M10/30°	35	1	503.350.01	503.350.02
M10/30°	45	1	503.450.01	503.450.02

For use with the following parts: **501 HW**

TECHNICAL DETAILS:

- Strength steel.
- Precision grinding on all contact surfaces.

APPLICATION:

for use on boring machines equipped with adaptors and/or chucks.



534

S mm				ORDER NO. Right-hand rotation	
MK2/Ø20x14F.x1"			1	534.020.01	
MK2/M30x1,5			1	534.030.01	

For use with the following parts: **501 HW**

TECHNICAL DETAILS:

- Strength steel.

APPLICATION:

for use on CNC machining centers or hand-held routers equipped with adaptors and/or chucks.

Extension for drills with hexagonal shank



507

S	mm	L inches	B mm		ORDER NO.
Hexagonal 1/4"	330	13	8	25	507.080.33
Hexagonal 11/32"	330	13	9,5	25	507.095.33
Hexagonal 11/32"	330	13	10	25	507.100.33

TECHNICAL DETAILS:

- High strength steel.
- Precision grinding on all contact surfaces.

Interchangeable Boring Bits with Threaded Shank

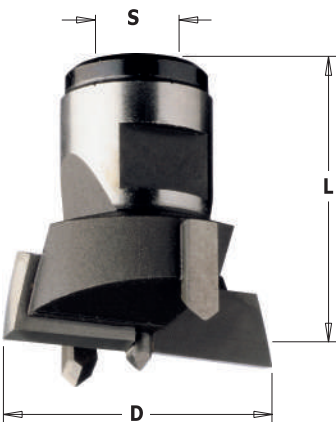

501

D mm	L mm	S mm			ORDER NO. Right-hand rotation	ORDER NO. Left-hand rotation
20	30	M12x1		1	501.200.11	501.200.12
22	30	M12x1		1	501.220.11	501.220.12
24	30	M12x1		1	501.240.11	501.240.12
25	30	M12x1		1	501.250.11	501.250.12
26	30	M12x1		1	501.260.11	501.260.12
30	30	M12x1		1	501.300.11	501.300.12
32	30	M12x1		1	501.320.11	501.320.12
34	30	M12x1		1	501.340.11	501.340.12
35	30	M12x1		1	501.350.11	501.350.12
36	30	M12x1		1	501.360.11	501.360.12
38	30	M12x1		1	501.380.11	501.380.12
40	30	M12x1		1	501.400.11	501.400.12
45	30	M12x1		1	501.450.11	501.450.12
50	30	M12x1		1	501.500.11	501.500.12
55	30	M12x1		1	501.550.11	501.550.12
60	30	M12x1		1	501.600.11	501.600.12

Boring Bits with Parallel Shank

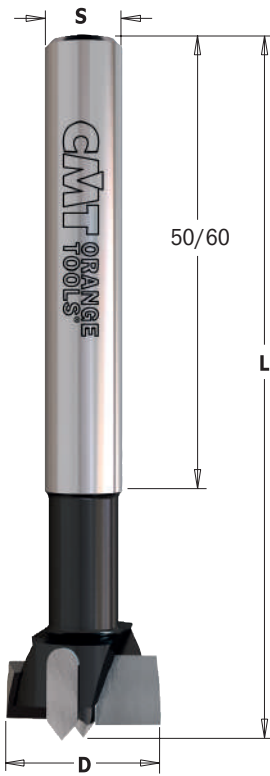

512

HW Z2 V2 RH

D mm	L mm	S mm		ORDER NO. Right-hand rotation
14	90	10x60	10	512.140.11
15	90	10x60	10	512.150.11
16	90	10x60	10	512.160.11
17	90	10x60	10	512.170.11
18	90	10x60	10	512.180.11
19	90	10x60	10	512.190.11
20	90	10x60	10	512.200.11
21	90	10x60	10	512.210.11
22	90	10x60	10	512.220.11
23	90	10x60	10	512.230.11
24	90	10x60	10	512.240.11
25	90	10x60	10	512.250.11
26	90	10x60	10	512.260.11
27	90	10x60	10	512.270.11
28	90	10x60	10	512.280.11
29	90	10x60	10	512.290.11
30	90	10x60	10	512.300.11
31	90	10x60	10	512.310.11
32	90	10x60	10	512.320.11
33	90	10x60	10	512.330.11
34	90	10x60	10	512.340.11
35	90	10x60	10	512.350.11
38	90	10x60	10	512.380.11
40	90	10x60	10	512.400.11
42	90	10x60	10	512.420.11
45	90	10x50	10	512.450.11
48	90	10x50	10	512.480.11
50	90	10x50	10	512.500.11
55	90	10x50	5	512.550.11
58	90	10x50	5	512.580.11
60	90	10x50	5	512.600.11

TECHNICAL DETAILS:

- Strength steel.
- HW balanced centre point.
- 2 HW ground cutting edges [Z2].
- 2 HW negatively ground spurs [V2].
- **Parallel shank.**

APPLICATION:

for drilling blind holes in solid wood, wood derivatives and laminate materials.

Ideal for hinges.

5 Piece Boring Bit Set for Hinges



512.001.01

HW Z2 V2 RH

The perfect set for hinge work and other related applications. Machined from special high speed steel and featuring tungsten carbide tipped cutting edges.

TECHNICAL DETAILS:

- Strength steel.
- HW balanced centre point.
- 2 HW ground cutting edges [Z2].
- 2 HW negatively ground spurs [V2].
- **Parallel shank.**

APPLICATION:

for drilling blind holes in solid wood, wood derivatives and laminated materials.

Ideal for hinges.

DESCRIPTION	S mm	L mm	BIT DIAMETER mm		ORDER NO. Right-hand rotation
5 Piece Boring Bit Set for Hinges	10	90	15-20-25-30-35	5	512.001.01

Boring Bits with Parallel Shank

SP Z2 V2 RH

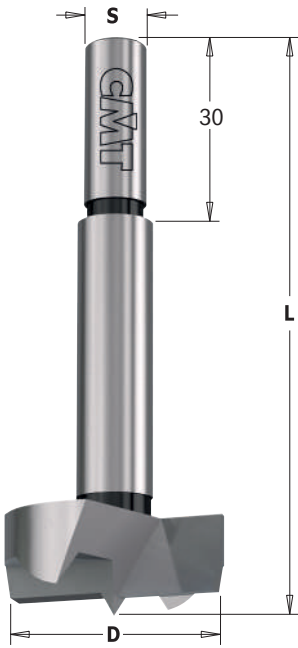

512

D mm	L mm	S mm		ORDER NO. Right-hand rotation
8	90	8x30	10	512.081.31
10	90	8x30	10	512.101.31
12	90	8x30	10	512.121.31
14	90	8x30	10	512.141.31
15	90	8x30	10	512.151.31
16	90	8x30	10	512.161.31
18	90	8x30	10	512.181.31
20	90	8x30	10	512.201.31
22	90	8x30	10	512.221.31
24	90	8x30	10	512.241.31
25	90	8x30	10	512.251.31
26	90	8x30	10	512.261.31
28	90	8x30	10	512.281.31
30	90	8x30	10	512.301.31
32	90	10x30	10	512.321.31
34	90	10x30	10	512.341.31
35	90	10x30	10	512.351.31
38	90	10x30	10	512.381.31
40	90	10x30	10	512.401.31
45	90	10x30	10	512.451.31
50	90	10x30	10	512.501.31

TECHNICAL DETAILS:

- Dependable DIYer tools. Great quality/price ratio.
- SP steel.
- SP balanced centre point.
- 2 SP ground cutting edges [Z2].
- 2 SP ground spurs [V2].
- Parallel shank.

APPLICATION:

used for drilling blind holes in solid wood, wood derivatives and laminates.
Ideal for hinges.

5 Piece Boring Bit Set for Hinges



512.001.00

SP Z2 V2 RH

The perfect hinge work set for the most popular brand applications. Machined from special high speed steel its really does a great job for those traditional hinge jobs.

TECHNICAL DETAILS:

- Dependable DIYer tools. Great quality/price ratio.
- SP steel.
- SP balanced centre point.
- 2 SP ground cutting edges [Z2].
- 2 SP ground spurs [V2].
- Parallel shank.

APPLICATION:

for drilling blind holes in solid wood, wood derivatives and laminates.
Ideal for hinges.

DESCRIPTION	S mm	L mm	BIT DIAMETER mm		ORDER NO. Right-hand rotation
5 Piece Boring Bit Set for Hinges	10	90	15-20-25-30-35	5	512.001.00

Boring Bits with Parallel Shank

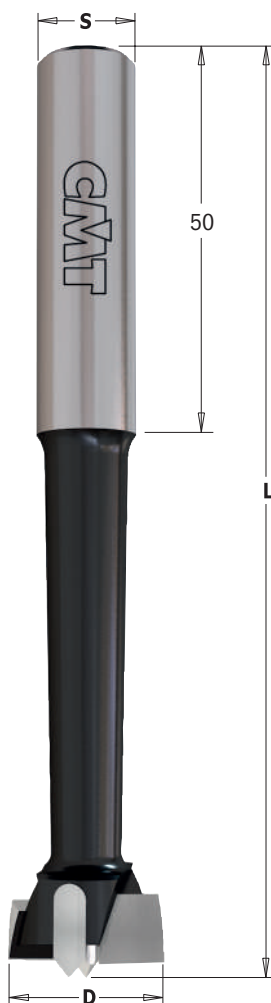
HW Z2 V2 RH

513

D mm	L mm	S mm		ORDER NO. Right-hand rotation
15	120	13	1	513.150.11
16	120	13	1	513.160.11
18	120	13	1	513.180.11
20	120	13	1	513.200.11
22	125	13	1	513.220.11
25	125	13	1	513.250.11
26	125	13	1	513.260.11
28	130	13	1	513.280.11
30	130	13	1	513.300.11
35	130	13	1	513.350.11
40	130	13	1	513.400.11
45	130	13	1	513.450.11
50	130	13	1	513.500.11
55	140	13	1	513.550.11
60	140	13	1	513.600.11

514

D mm	L mm	S mm		ORDER NO. Right-hand rotation
15	120	16	1	514.150.11
16	120	16	1	514.160.11
18	120	16	1	514.180.11
20	120	16	1	514.200.11
22	125	16	1	514.220.11
25	125	16	1	514.250.11
26	125	16	1	514.260.11
28	130	16	1	514.280.11
30	130	16	1	514.300.11
32	130	16	1	514.320.11
35	130	16	1	514.350.11
40	130	16	1	514.400.11
45	130	16	1	514.450.11
50	130	16	1	514.500.11
55	140	16	1	514.550.11
60	140	16	1	514.600.11

TECHNICAL DETAILS:

- Strength steel.
- HW balanced centre point.
- 2 HW ground cutting edges [Z2].
- 2 HW negatively ground spurs [V2].
- **Parallel shank.**

APPLICATION:

for drilling blind holes in solid wood, wood derivatives and laminates.

Ideal for hinges.

Boring Bits with Parallel Shank

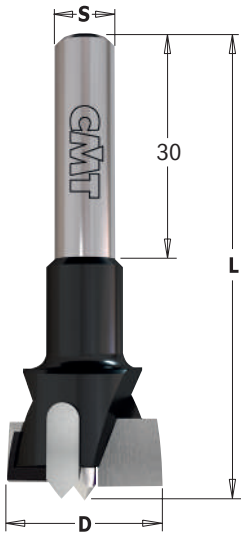

392

HW **Z2** **V2** **RH**

D mm	L mm	S mm		ORDER NO. Right-hand rotation
15	60	8	10	392.150.11
20	60	8	10	392.200.11
25	60	8	10	392.250.11
26	60	8	10	392.260.11
30	60	8	10	392.300.11
35	60	8	10	392.350.11
35	60	12,7	10	392.351.11
40	60	8	10	392.400.11

TECHNICAL DETAILS:

- Strength steel.
- HW balanced centre point.
- 2 HW ground cutting edges [Z2].
- 2 HW negatively ground spurs [V2].
- **Parallel shank.**

APPLICATION:

for drilling blind holes in solid wood, wood derivatives and laminates.
Ideal for hinges.

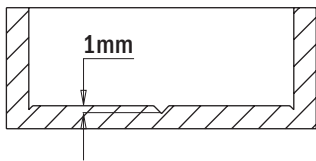

New construction with 1mm centre point

Mortise Chisel & Bit Sets



543

HSS **Z1** **RH**

mm	D	inches	mm	S	inches		ORDER NO. Right-hand rotation
6,35		1/4	19		3/4	1	543.064.51
8		5/16	19		3/4	1	543.079.51
9,5		3/8	19		3/4	1	543.095.51
12,7		1/2	19		3/4	1	543.127.51
15,8		5/8	19		3/4	1	543.158.51
19		3/4	19		3/4	1	543.190.51

It's tough to beat the old faithful mortise and tenon joint for strength and accuracy, even with all the other joinery options in the world of woodworking. It isn't the easiest joint to make, but it surely helps to have the best quality tools in your shop. That's why we've added a new selection of chisel and bit sets in all the popular sizes 6,35mm (1/4") to 19mm (3/4") diameter.

These sets are for use on any standard drill press mortising attachment of mortising machines.



Sample of Chisel Mortiser

SP RH

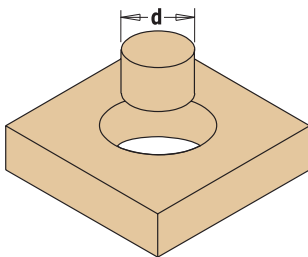

529

d mm	D mm	L mm	S mm	Z		ORDER NO. Right-hand rotation
8	18	140	13	4	5	529.080.31
10	20	140	13	4	5	529.100.31
12	24	140	13	4	5	529.120.31
14	26	140	13	4	5	529.140.31
15	27	140	13	4	5	529.150.31
16	28	140	13	4	5	529.160.31
18	30	140	13	4	5	529.180.31
20	32	140	13	4	5	529.200.31
22	34	140	13	5	5	529.220.31
25	37	140	13	5	5	529.250.31
30	42	140	13	5	5	529.300.31
32	44	140	13	5	5	529.320.31
35	47	160	16	6	2	529.350.31
40	52	160	16	6	2	529.400.31
45	57	160	16	6	2	529.450.31
50	62	160	16	6	2	529.500.31

d inches	D inches	L inches	S inches	Z		ORDER NO. Right-hand rotation
3/8	49/64	5-1/2	1/2	4	5	529.095.31
1/2	61/64	5-1/2	1/2	4	5	529.127.31
5/8	1-7/64	5-1/2	1/2	4	5	529.158.31
3/4	1-7/32	5-1/2	1/2	4	5	529.191.31
7/8	1-11/32	5-1/2	1/2	4	5	529.222.31
1	1-15/32	5-1/2	1/2	5	5	529.254.31
1-1/4	1-19/32	5-1/2	1/2	5	5	529.317.31
1-3/8	1-27/32	6-5/16	5/8	6	2	529.349.31
1-1/2	1-31/32	6-5/16	5/8	6	2	529.381.31
1-5/8	2-3/32	6-5/16	5/8	6	2	529.413.31
1-3/4	2-7/32	6-5/16	5/8	6	2	529.445.31
2	2-15/32	6-5/16	5/8	6	2	529.508.31

Use our D=16mm bushing to increase the 13mm shank (article no. **799.130.00** on page 440)

TECHNICAL DETAILS:

- Dependable DIYer tools. Great quality/price ratio.
- SP steel.
- 4 cutting edges.

APPLICATION:

for drilling plugs in natural soft or medium-density woods.

D mm	D inches	Max RPM Softwood	Max RPM Hardwood
< Ø16	5/8	1000	500
< Ø40	1-37/64	500	300
> Ø40	1-37/64	200	150

500.001/02/03

SP RH

We offer a wide range of boring bits and plug cutters in the most popular diameters. If you need to drill plugs in soft to medium-density hardwood, you've got three different sets to choose from. **Dependable DIYer tools. Great quality/price ratio.**



500.001.08 BORING BIT & PLUG CUTTER SET

SET CONTAINS	D mm	L mm	S mm	ORDER NO. Right-hand rotation
Boring Bit with Parallel Shank	8	90	10	512.081.31
Boring Bit with Parallel Shank	10	90	10	512.101.31
Boring Bit with Parallel Shank	12	90	10	512.121.31
Boring Bit with Parallel Shank	15	90	10	512.151.31
Plug Cutter	8	140	13	529.080.31
Plug Cutter	10	140	13	529.100.31
Plug Cutter	12	140	13	529.120.31
Plug Cutter	15	140	13	529.150.31



500.002.08 BORING BIT & PLUG CUTTER SET

SET CONTAINS	D mm	L mm	S mm	ORDER NO. Right-hand rotation
Boring Bit with Parallel Shank	16	90	10	512.161.31
Boring Bit with Parallel Shank	20	90	10	512.201.31
Boring Bit with Parallel Shank	25	90	10	512.251.31
Boring Bit with Parallel Shank	30	90	10	512.301.31
Plug Cutter	16	140	13	529.160.31
Plug Cutter	20	140	13	529.200.31
Plug Cutter	25	140	13	529.250.31
Plug Cutter	30	140	13	529.300.31

500.003.08 BORING BIT & PLUG CUTTER SET

SET CONTAINS	D mm	L mm	S mm	ORDER NO. Right-hand rotation
Boring Bit with Parallel Shank	15	90	10	512.151.31
Boring Bit with Parallel Shank	20	90	10	512.201.31
Boring Bit with Parallel Shank	25	90	10	512.251.31
Boring Bit with Parallel Shank	30	90	10	512.301.31
Plug Cutter	15	140	13	529.150.31
Plug Cutter	20	140	13	529.200.31
Plug Cutter	25	140	13	529.250.31
Plug Cutter	30	140	13	529.300.31



537

D mm	L mm	S mm		ORDER NO. Right-hand rotation
10	90	8	6	537.100.31
12	90	8	6	537.120.31
14	90	8	6	537.140.31
15	90	8	6	537.150.31
16	90	8	6	537.160.31
18	90	8	6	537.180.31
20	90	8	6	537.200.31
22	90	8	6	537.220.31
24	90	8	6	537.240.31
25	90	8	6	537.250.31
26	90	8	6	537.260.31
28	90	8	6	537.280.31
30	90	8	6	537.300.31
32	90	10	6	537.320.31
35	90	10	6	537.350.31
38	90	10	6	537.380.31
40	90	10	6	537.400.31
45	90	10	6	537.450.31
50	90	10	6	537.500.31
55	90	10	6	537.550.31
68	157	12,7	6	537.680.31
70	157	12,7	6	537.700.31
75	157	12,7	2	537.750.31
80	157	12,7	2	537.800.31
85	157	12,7	2	537.850.31
90	157	12,7	2	537.900.31
95	157	12,7	2	537.950.31
100	157	12,7	2	537.990.31



STANDARD RIM AND TOOTHED RIM:

Standard rims provide better guidance but tend to over-heat. To overcome heat the larger diameters (>=Ø25mm) are designed with toothed rims.

D inches	L inches	S inches		ORDER NO. Right-hand rotation
1/4	3-35/64	3/8	6	537.064.31
3/8	3-35/64	3/8	6	537.095.31
1/2	3-35/64	3/8	6	537.127.31
5/8	3-35/64	3/8	6	537.158.31
3/4	3-35/64	3/8	6	537.190.31
7/8	3-35/64	3/8	6	537.222.31
1	3-35/64	3/8	6	537.254.31
1-1/8	3-35/64	3/8	6	537.285.31
1-1/4	3-35/64	3/8	6	537.317.31
1-3/8	3-35/64	3/8	6	537.349.31
1-1/2	3-35/64	3/8	6	537.381.31
1-5/8	3-35/64	3/8	6	537.413.31
1-3/4	3-35/64	3/8	6	537.445.31
1-7/8	3-35/64	3/8	6	537.476.31
2	3-35/64	3/8	6	537.508.31
2-1/8	3-35/64	3/8	6	537.540.31
2-1/4	6-3/16	3/8	6	537.571.31
2-1/2	6-3/16	3/8	6	537.635.31
3	6-3/16	3/8	2	537.762.31
3-1/2	6-3/16	3/8	2	537.889.31
4	6-3/16	3/8	2	537.991.31
4-1/2	4-17/32	3/8	2	537.993.31

TECHNICAL DETAILS:

- Dependable DIYer tools. Great quality/price ratio.
- SP steel.
- SP balanced centre point.
- 2 SP precision ground cutting edges [Z2].
- 2 SP ground spurs [V2].
- Parallel shank.

APPLICATION:

for drilling flat bottom holes of any size in softwood. Create oval and arched openings at any angle. Create niches for the installation of brackets/straps, frames/grids.

Forstner Bit Sets

We offer a wide range of Forstner bits in the most popular diameters to execute holes for brackets/straps in softwood. Drill ovals and arched openings at any angle for the installation of hinge parts. Available in 4, 5, 7, 12 and 16 bit sets.

Dependable DIYer tools. Great quality/price ratio.

537.000.16

- 537.000.04
- 537.000.05
- 537.000.07
- 537.000.12



DESCRIPTION	SHANK mm	SHANK inches	BIT DIAMETER		ORDER NO. Right-hand rotation
5 pcs. Forstner Bit Set in clamshell	Ø8-10		Ø15-20-25-30-35mm	6	537.000.05
12 pcs. Forstner Bit Set in clamshell	Ø8-10		Ø10-12-14-15-16-18-20-22-25-26-30-35mm	6	537.000.12
4 pcs. Forstner Bit Set in clamshell		Ø3/8	Ø1/4" - 1/2" - 3/4" - 1"	6	537.000.04
7 pcs. Forstner Bit Set in clamshell		Ø3/8	Ø1/4" - 3/8" - 1/2" - 5/8" - 3/4" - 7/8" - 1"	6	537.000.07
16 pcs. Forstner Bit Set in plastic box		Ø3/8	Ø1/4" - 3/8" - 1/2" - 5/8" - 3/4" - 7/8" - 1" - 1-1/8" - 1-1/4" - 1-3/8" - 1-1/2" - 1-5/8" - 1-3/4" - 1-7/8" - 2" - 2-1/8"	8	537.000.16



531

HW **Z2** **RH**

D mm	L mm	S mm	MAX RPM		ORDER NO. Right-hand rotation
54	73,5	9,5	1500	10	531.541
54	71,3	9,5	1500	10	531.542
54	67,3	9,5	1500	10	531.543
54	72,3	9,5	1500	10	531.544
70	76,5	9,5	1000	5	531.701
70	74	9,5	1000	5	531.702

TECHNICAL DETAILS:

- Strength steel.
- 2 HW precision ground cutting edges [Z2].
- Parallel hexagonal shank.

APPLICATION:

for use on drill presses and low speed power tools (see table above for max RPM). We recommend securely clamping your workpiece throughout drilling operations.

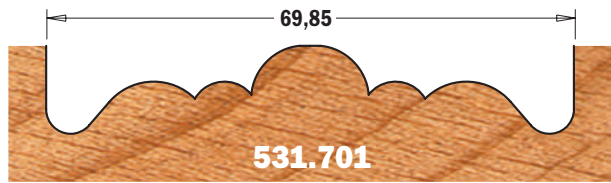
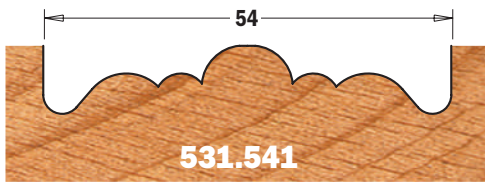

Drawing is 1:1 scale



531.541
531.701

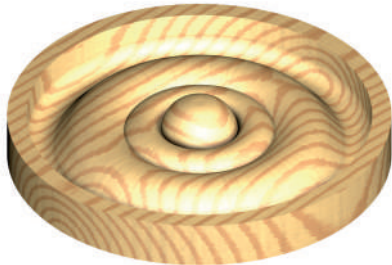

531.543

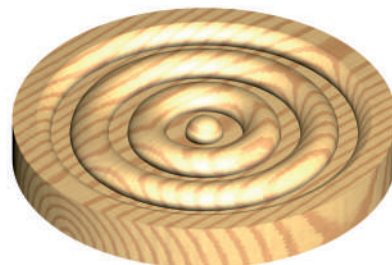

531.542
531.702

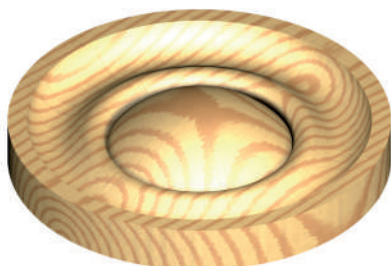

531.544

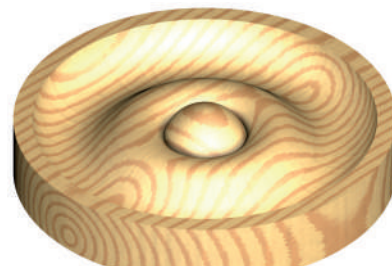



312

HW Z2 RH

D mm	I mm	L mm	S mm		ORDER NO. Right-hand rotation
4	30	58	8	10	312.040.11
5	30	58	8	10	312.050.11
6	30	58	8	10	312.060.11
8	30	58	8	10	312.080.11
10	30	58	8	10	312.100.11
12	30	58	8	10	312.120.11
14	30	58	8	10	312.140.11
16	30	58	8	10	312.160.11

TECHNICAL DETAILS:

- Premium quality strength steel body.
- High quality HW tip.
- 2 cutting edges [Z2].
- No lateral spurs.
- 2 spiral flutes.
- Balanced centre point.
- Black P.T.F.E. coating.
- **Parallel shank with driving flat and length adjusting screw.**

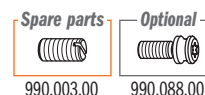

APPLICATION:

for drilling blind holes in solid wood, wood derivatives and laminates.
For use on hand-held routers and MAFELL® machines - model DD40.

Router Bits for DOMINO® Joining Machines by FESTOOL®



380

HW HWM Z2 RH

D mm	I mm	L mm	S mm	FESTOOL®		ORDER NO. Right-hand rotation
• 4	11	38	M6x0,75	DF500	10	380.040.11
5	20	49	M6x0,75	DF500	10	380.050.11
6	28	49	M6x0,75	DF500	10	380.060.11
8	28	49	M6x0,75	DF500	10	380.080.11
10	28	49	M6x0,75	DF500	10	380.100.11
8	50	90	M8x1	DF700	10	380.081.11
10	70	90	M8x1	DF700	10	380.101.11
12	70	90	M8x1	DF700	10	380.121.11
14	70	90	M8x1	DF700	10	380.141.11

• HWM

TECHNICAL DETAILS:

- Premium quality strength steel body.
- High quality HW tip.
- 2 cutting edges [Z2].
- No lateral spurs.
- 2 spiral flutes.
- Black P.T.F.E. coating.
- Threaded shank.

APPLICATION:

for use on "DOMINO®" machines to rout slots for hinges.

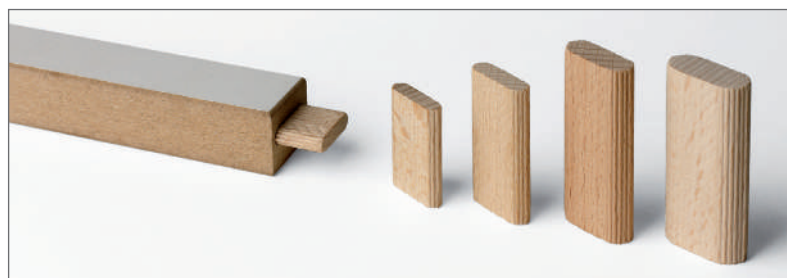

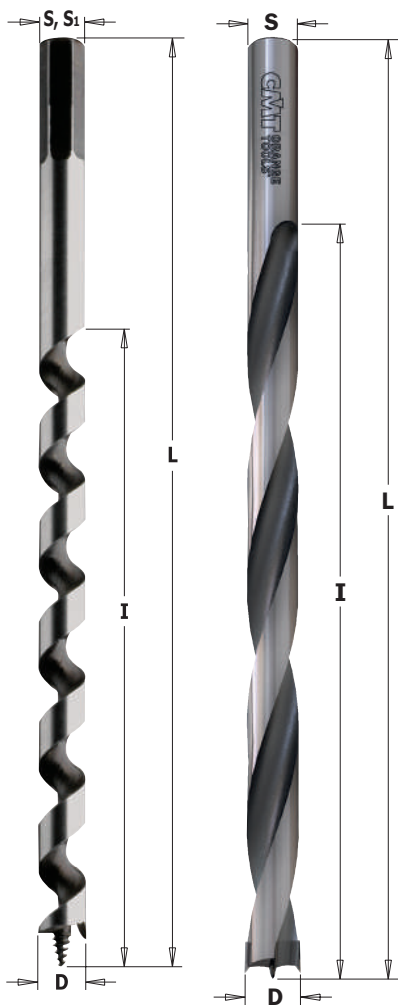

542-535

HSS **Z1** **V1** **RH**

D mm	I mm	L mm	S	S ₁ mm	RPM max		ORDER NO. Right-hand rotation
6	155	230	Hexagonal	6	800 ~ 1400	1	542.060.51
8	155	230	Hexagonal	6,35	800 ~ 1400	1	542.080.51
10	155	230	Hexagonal	9	600 ~ 1200	1	542.100.51
12	155	230	Hexagonal	12	600 ~ 1100	1	542.120.51
14	155	230	Hexagonal	12	600 ~ 1000	1	542.140.51
16	155	230	Hexagonal	12	500 ~ 900	1	542.160.51
18	155	230	Hexagonal	12	500 ~ 800	1	542.180.51
20	155	230	Hexagonal	12	400 ~ 700	1	542.200.51
8	360	460	Hexagonal	6,55	800 ~ 1000	1	535.080.51
10	360	460	Hexagonal	9	600 ~ 1000	1	535.100.51
12	360	460	Hexagonal	12	600 ~ 1000	1	535.120.51
14	360	460	Hexagonal	12	500 ~ 900	1	535.140.51
16	360	460	Hexagonal	12	500 ~ 900	1	535.160.51
18	360	460	Hexagonal	12	450 ~ 800	1	535.180.51
20	360	460	Hexagonal	12	400 ~ 700	1	535.200.51

TECHNICAL DETAILS:

- HSS steel.
- Balanced centre point.
- 1 HSS cutting edge [Z1] + 1 spur [V1].
- 1 spiral flute.

APPLICATION:

for deep boring on soft and medium-density wood. Ideal for the preparation and installation of floating shelves.

542

HW **Z2** **V2** **RH**

D mm	I mm	L mm	S mm		ORDER NO. Right-hand rotation
12	180	240	13	1	542.120.11
14	180	240	13	1	542.140.11

TECHNICAL DETAILS:

- Strength steel.
- High quality HW tip.
- Balanced centre point.
- 2 HW cutting edge [Z2] + 2 spurs [V2].
- 2 spiral flute.

APPLICATION:

for deep boring on soft and medium-density wood. Ideal for the preparation and installation of floating shelves.

Brad Point Bits & Stop Collars

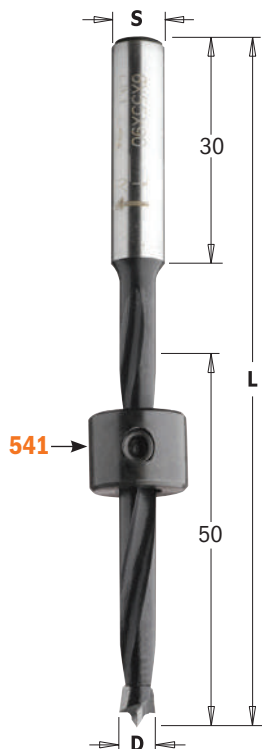

540

HW **Z2** **V2** **RH**

D mm	L mm	S mm		ORDER NO. Right-hand rotation
5	90	8x30	1	540.050.11
6	90	8x30	1	540.060.11
8	90	8x30	1	540.080.11
10	90	8x30	1	540.100.11
12	90	8x30	1	540.120.11

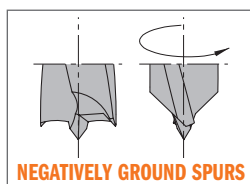

TECHNICAL DETAILS:

- Strength steel.
- High quality HW tip.
- Balanced centre point.
- 2 HW cutting edge [Z2] + 2 spurs [V2].
- 2 spiral flute.

APPLICATION:

for drilling blind holes in solid wood, wood derivatives and laminates. For use on hand-held power drills and drill presses.

541 Stop Collars

D mm		ORDER NO.
5	10	541.050.00
6	10	541.060.00
8	10	541.080.00
10	10	541.100.00
12	10	541.120.00

Spare parts

990.002.00	991.062.00
990.002.00	991.062.00
990.002.00	991.062.00
990.002.00	991.062.00
990.002.00	991.062.00

Stop collars with precision clamping nut and key for quick and easy assembly.

Brad Point Bits

SP HSS Z2 RH

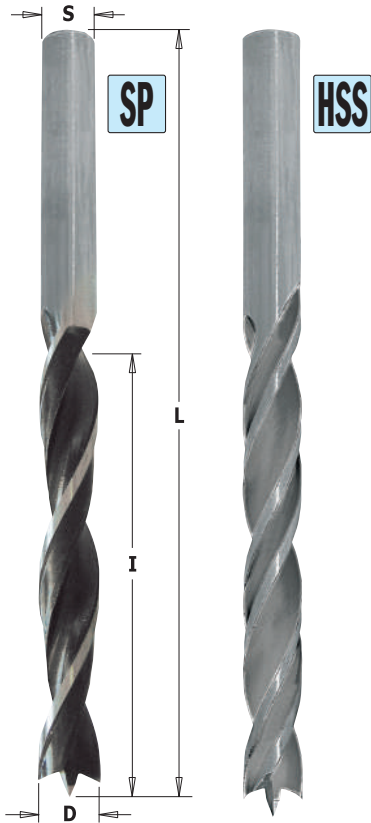

517

D mm	I mm	L mm	S mm		ORDER NO. Right-hand rotation	SP	ORDER NO. Right-hand rotation	HSS
3	33	61	3,0	1	517.030.31		517.030.51	
4	43	75	4	1	517.040.31		517.040.51	
4,5	47	80	4,5	1			517.045.51	
5	52	86	5	1	517.050.31		517.050.51	
6	57	93	6	1	517.060.31		517.060.51	
7	69	109	7	1	517.070.31		517.070.51	
8	75	117	8	1	517.080.31		517.080.51	
9	80	120	9	1	517.090.31		517.090.51	
10	80	120	10	1	517.100.31		517.100.51	
11	89	142	8	1	517.110.31		517.110.51	
12	96	151	8	1	517.120.31		517.120.51	
13	96	151	8	1	517.130.31		517.130.51	
14	96	151	10	1	517.140.31		517.140.51	
15	100	160	10	1	517.150.31		517.150.51	
16	100	160	10	1	517.160.31		517.160.51	
18	130	180	10	1	517.180.31			
20	135	200	10	1	517.200.31			

SP

TECHNICAL DETAILS:

- Dependable DIYer tools. Great quality/price ratio.
- SP steel.
- Balanced center point.
- 2 SP cutting edges [Z2].
- 2 flutes.

APPLICATION:

for drilling holes in natural wood.

HSS

TECHNICAL DETAILS:

- Dependable DIYer tools. Great quality/price ratio.
- HSS steel.
- Balanced center point.
- 2 HSS cutting edges [Z2].
- 4 spiral flutes.

APPLICATION:

used for drilling holes in soft and hardwood.

Brad Point Bit Sets

HSS SP Z2 RH



517

● **5 Piece Brad Point Bit Set**

Safely packaged in a reusable plastic case for easy storage and access. Dependable DIYer tools. Great quality/price ratio.

● **8 Piece Brad Point Bit Set**

Safely packaged in a reusable plastic case for easy storage and access. Dependable DIYer tools. Great quality/price ratio.

DESCRIPTION	Z	BIT DIAMETER		ORDER NO. Right-hand rotation
5 pcs. HSS Brad Point Set	4 flutes	Ø4-5-6-8-10mm	50	517.001.01
5 pcs. SP Brad Point Set	2 flutes	Ø4-5-6-8-10mm	50	517.001.00
8 pcs. HSS Brad Point Set	4 flutes	Ø3-4-5-6-7-8-9-10mm	30	517.002.01
8 pcs. SP Brad Point Set	2 flutes	Ø3-4-5-6-7-8-9-10mm	30	517.002.00

Brad Point Bits

HSS Z2 RH LH

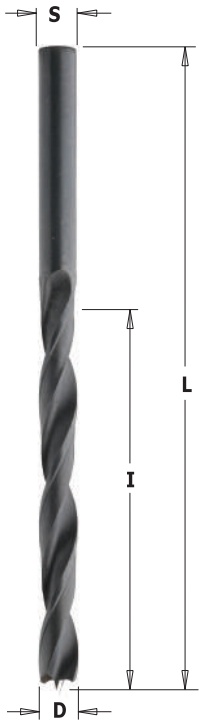

516

D mm	I mm	L mm	S mm		ORDER NO. Right-hand rotation	ORDER NO. Left-hand rotation
2	24	49	2	10	516.020.51	516.020.52
2,5	30	57	2,5	10	516.025.51	516.025.52
3	33	61	3	10	516.030.51	516.030.52
3,5	39	70	3,5	10	516.035.51	516.035.52
4	43	75	4	10	516.040.51	516.040.52
4,5	47	80	4,5	10	516.045.51	516.045.52
5	52	86	5	10	516.050.51	516.050.52
5,5	57	93	5,5	10	516.055.51	516.055.52
6	57	93	6	10	516.060.51	516.060.52
7	69	109	7	10	516.070.51	516.070.52
8	75	117	8	10	516.080.51	516.080.52
9	81	125	9	10	516.090.51	516.090.52
10	87	133	10	10	516.100.51	516.100.52

TECHNICAL DETAILS:
 - HSS steel.
 - Balanced centre point.
 - 2 HSS cutting edges [Z2].
 - 2 spiral flutes.

APPLICATION:
 for drilling blind holes in soft and medium-density wood.

Drill Bits for ANUBA® Hinges

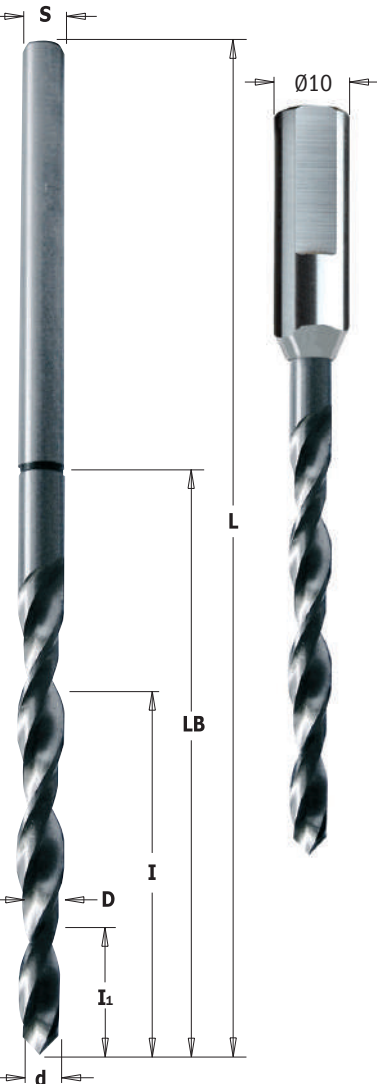

515 PARALLEL SHANK

HSS Z2 RH

ANUBA® nr.	d mm	D-S mm	I ₁ mm	I mm	LB mm	L mm		ORDER NO. Right-hand rotation
9,5	3,8	5,2	18	56	74	132	1	515.095.51
11	4,8	5,7	17	60	76	145	1	515.110.51
13	5,8	6,7	18	68	83	155	1	515.130.51
14,5	6,3	7,2	19	75	89	165	1	515.145.51
16	6,7	7,7	25	85	100	165	1	515.160.51
18	7,7	8,7	25	85	102	165	1	515.180.51
20	8,8	9,8	25	90	104	165	1	515.200.51

515 PARALLEL SHANK WITH DRIVING FLAT

ANUBA® nr.	d mm	D mm	I mm	LB mm	S mm	L mm		ORDER NO. Right-hand rotation
13	5,2	6,5	15	50	10x35	85	1	515.131.51
14	5,5	7	15	55	10x35	90	1	515.141.51
16	6	7,7	15	60	10x35	95	1	515.161.51

TECHNICAL DETAILS:
 - HSS steel.
 - Balanced centre point.
 - 2 HSS cutting edges [Z2].
 - 2 spiral flutes.

APPLICATION:
 for drilling holes in medium density wood.
 For the installation of ANUBA® hinges.



Countersinks with Threaded Shank

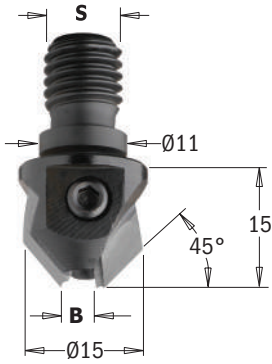

350



B mm	S mm		10	ORDER NO. Right-hand rotation	ORDER NO. Left-hand rotation
3	M10/Ø11x4		10	350.030.11	350.030.12
4	M10/Ø11x4		10	350.040.11	350.040.12
5	M10/Ø11x4		10	350.050.11	350.050.12

TECHNICAL DETAILS:

- Strength steel.
- Countersink: 2 carbide tipped cutting edges [Z2] at 45°.
- Fastening screw for quick and easy drill bit change.
- Threaded shank.

Spare parts



990.001.00

APPLICATION:

for use with spiral bits featuring a parallel shank of equal dimension to countersink shank diameter.

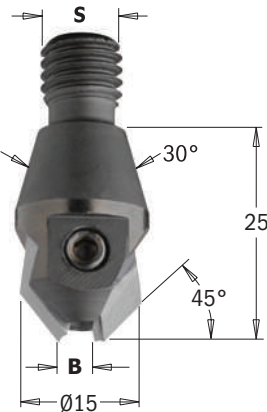

351

B mm	S mm		10	ORDER NO. Right-hand rotation	ORDER NO. Left-hand rotation
3	M10/30°		10	351.030.11	351.030.12
4	M10/30°		10	351.040.11	351.040.12
5	M10/30°		10	351.050.11	351.050.12

TECHNICAL DETAILS:

- Strength steel.
- Countersink: 2 carbide tipped cutting edges [Z2] at 45°.
- Fastening screw for quick and easy drill bit change.
- Threaded shank.

Spare parts



990.001.00

APPLICATION:

for use with spiral bits featuring a parallel shank of equal dimension to countersink shank diameter.

Adjustable Countersink

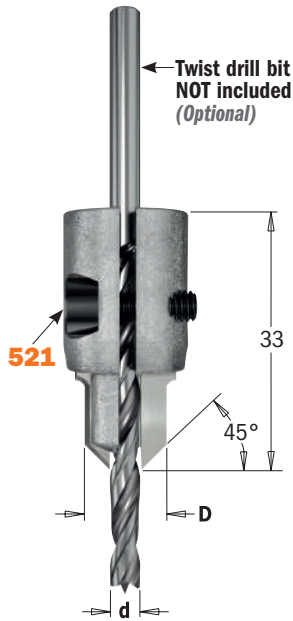

521.001



d mm	D mm	10	ORDER NO. Right-hand rotation	Spare parts	
3 ~ 7	10 ~ 14	10	521.001.11	990.061.00	991.067.00

For use with the following items: 516-517

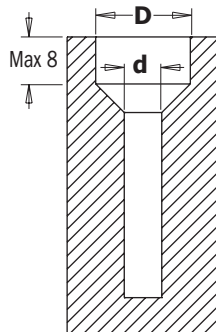

d	D
Ø3	Ø10
Ø4	Ø11
Ø5	Ø12
Ø6	Ø13
Ø7	Ø14

TECHNICAL DETAILS:

- Strength steel.
- Countersink: 2 carbide tipped cutting edges [Z2] at 45°.
- Fastening screw for quick and easy drill bit change.
- 3mm hex key included.
- Dependable DIYer tools. Great quality/price ratio.

APPLICATION:

for use with spiral bits featuring a parallel shank of equal dimension to countersink shank diameter.

Drill Bits with 45° Countersink Set

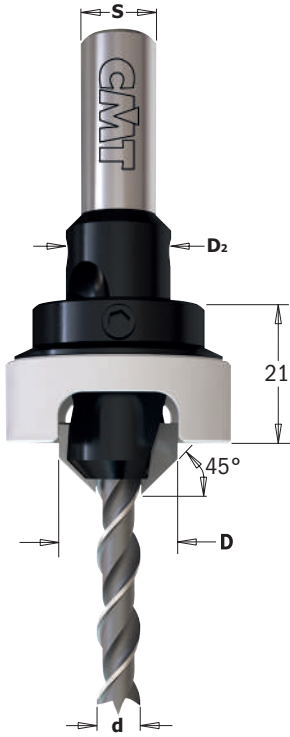

521A

d mm	D mm	D ₂ mm	A	S mm		ORDER NO. Right-hand rotation
3	12	10	45°	8	10	521.312.11A
4	12	10	45°	8	10	521.412.11A
4,5	16	14	45°	10	10	521.4516.11A
5	16	14	45°	10	10	521.516.11A
6	16	14	45°	10	10	521.616.11A

Spare parts: 990.014.00 Screw
991.060.00 Hex key

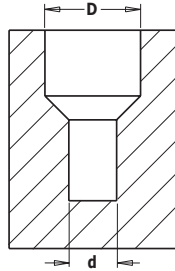

TECHNICAL DETAILS:

- Strength steel.
- Countersink: 2 carbide tipped cutting edges [Z2] at 45°.
- Fastening screw for quick and easy drill bit change.
- HSS drill bit.
- Stop collars with precision clamping nut for quick and easy assembly.
- The DELRIN® protection sleeve lets you work without marring the workpiece.

APPLICATION:

for drilling countersink and blind holes in solid wood, wood derivatives and laminates. For use with hand-held power drills or drill presses.

Spare parts

521.312.11	517.030.51P	541.101.00
521.412.11	517.040.51P	541.101.00
521.4516.11	517.045.51P	541.141.00
521.516.11	517.050.51P	541.141.00
521.616.11	517.060.51P	541.141.00

HW **Z2** **RH**

Drill Bits with 90° Countersink Set

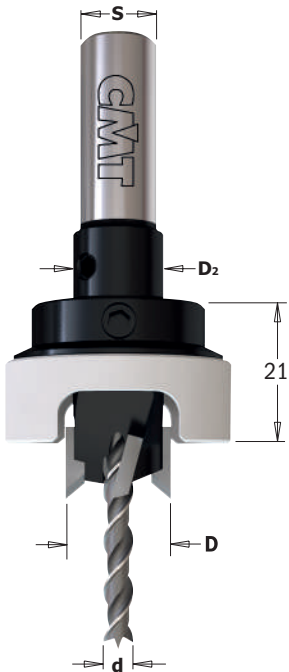

515A

d mm	D mm	D ₂ mm	S mm		ORDER NO. Right-hand rotation
4	12	10	10	10	515.412.11A
4	14	12	10	10	515.414.11A
4	15	14	10	10	515.415.11A
5	15	14	10	10	515.515.11A
6	14	12	10	10	515.614.11A
6	15	14	10	10	515.615.11A

Spare parts: 990.014.00 Screw
991.060.00 Hex key

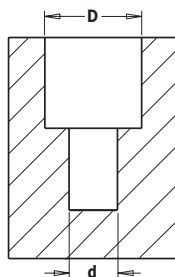

TECHNICAL DETAILS:

- Strength steel.
- Countersink: 2 carbide tipped cutting edges [Z2] at 90°.
- Fastening screw for quick and easy drill bit change.
- HSS drill bit.
- Stop collars with precision clamping nut for quick and easy assembly.
- The DELRIN® protection sleeve lets you work without marring the workpiece.

APPLICATION:

for drilling countersink and blind holes in solid wood, wood derivatives and laminates. For use with hand-held power drills or drill presses.

Spare parts

515.412.11	517.040.51P	541.101.00
515.414.11	517.040.51P	541.121.00
515.415.11	517.040.51P	541.141.00
515.515.11	517.050.51P	541.141.00
515.614.11	517.060.51P	541.121.00
515.615.11	517.060.51P	541.141.00

HW **Z2** **V2** **RH**

Stop Collars with DELRIN® Sleeve

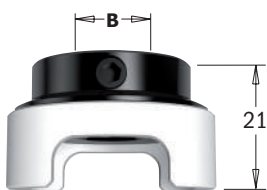

541

B mm		ORDER NO.
10	1	541.101.00
12	1	541.121.00
14	1	541.141.00

Spare parts

990.014.00	991.060.00
990.014.00	991.060.00
990.014.00	991.060.00

TECHNICAL DETAILS:

- Stop collars with precision clamping nut for quick and easy assembly.
- The DELRIN® protection sleeve lets you work without marring the workpiece.

45° Countersink with Parallel Shank

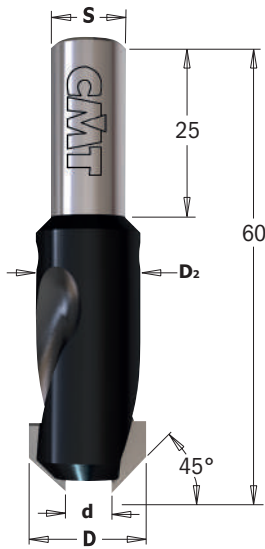
521
HW Z2 RH LH

d mm	D mm	D ₂ mm	A	S mm		ORDER NO. Right-hand rotation	ORDER NO. Left-hand rotation
3	12	10	45°	8	10	521.312.11	521.312.12
4	12	10	45°	8	10	521.412.11	521.412.12
4,5	16	14	45°	10	10	521.4516.11	
5	16	14	45°	10	10	521.516.11	521.516.12
6	16	14	45°	10	10	521.616.11	521.616.12

Spare parts



990.014.00

990.014.00

990.014.00

990.014.00

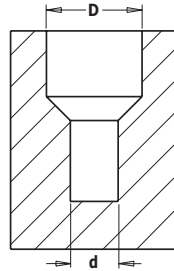
990.014.00

Spare parts: 991.060.00 2mm hex key

TECHNICAL DETAILS:

- Strength steel.
- Countersink: 2 carbide tipped cutting edges [Z2] at 45°.
- Fastening screw for quick and easy drill bit change.

APPLICATION:

for use with spiral bits featuring a parallel shank of equal dimension to countersink shank diameter.

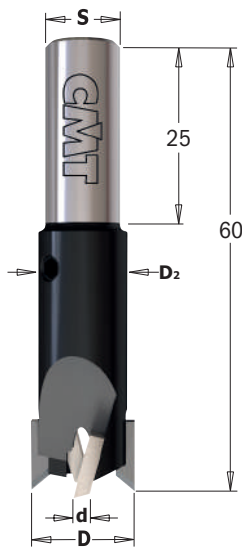
90° Countersink with Parallel Shank

515
HW Z2 V2 RH

d mm	D mm	D ₂ mm	A	S mm		ORDER NO. Right-hand rotation	
4	12	10	90°	10	10	515.412.11	
4	14	12	90°	10	10	515.414.11	
4	15	14	90°	10	10	515.415.11	
5	15	14	90°	10	10	515.515.11	
6	14	12	90°	10	10	515.614.11	
6	15	14	90°	10	10	515.615.11	

Spare parts

990.014.00

990.014.00

990.014.00

990.014.00

990.014.00

990.014.00

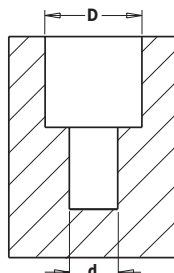
Spare parts: 991.060.00 2mm hex key

TECHNICAL DETAILS:

- Strength steel.
- Countersink: 2 carbide tipped cutting edges [Z2] at 90°.
- Fastening screw for quick and easy drill bit change.

APPLICATION:

for use with spiral bits featuring a parallel shank of equal dimension to countersink shank diameter.

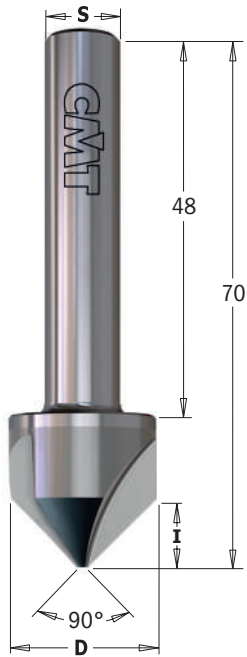
90° Solid Carbide Countersink with Parallel Shank



521

HWM Z3 RH

D mm	I mm	L mm	S mm		ORDER NO. Right-hand rotation
19,5	9	70	10x48	10	521.002.11

TECHNICAL DETAILS:

- Premium quality strength steel body.
- High quality HW tip.
- 3 cutting edges [Z3] at 90°.
- Parallel shank.

APPLICATION:

for making 90° countersinks for the insertion of screws that sit flush with the surface. Suitable for wood, wood-based, non-ferrous materials and metal.

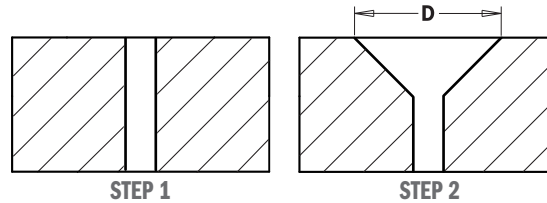

Drill Bit with Countersink for Screw Joints

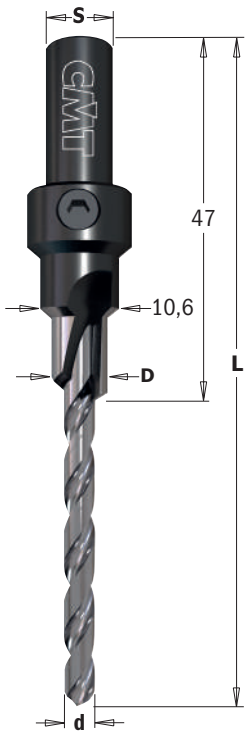

515

SP Z1 RH

d mm	D mm	L mm	S mm		ORDER NO. Right-hand rotation
4,2	7,6	87	9	1	515.042.31
5	7,6	93,7	9	1	515.050.31

TECHNICAL DETAILS:

- SP steel.
- Countersink: 1 SP cutting edge [Z1].
- HSS drill bit.

APPLICATION:

for drilling blind holes in soft and hardwood.

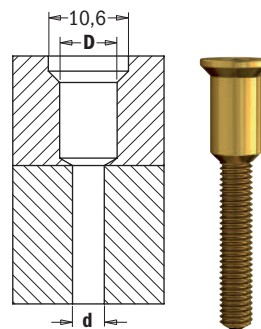

CMT XTREME FAST AND PUSH&LOCK SYSTEMS: NEXT GENERATION HOLE SAW



These hole saws, equipped with the new **XTREME FAST** system, have been improved to ensure maximum productivity, lifetime and unbeatable performance in all materials. The innovative patented **PUSH&LOCK** system makes the traditional hole saw arbor obsolete.

NEW FEATURES: 1. One **PUSH&LOCK** arbor for all Hole Saw Series & Diameters. 2. Change your Hole Saw, with a simple **PUSH&LOCK**. 3. Release Plug with a push. 4. Enlarge the existing hole.

SERIES 550X: MULTI-PURPOSE









MATERIALS



 WOOD/PLYWOOD	 MDF/LAMINATES	 PLASTERBOARD
 PLASTICS	 BRICKS AERATED CONCRETE	 SOFT TILES

SERIES 551X: BI-METAL PLUS

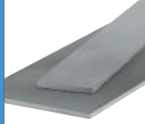
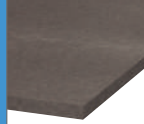
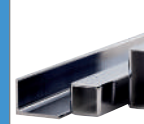

MATERIALS

 STAINLESS STEEL	 CAST IRON	 STEEL
 ALUMINIUM	 COPPER/BRASS	 PLASTICS

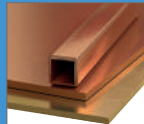
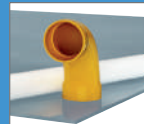
SERIES 552: DIAMOND DRY





MATERIALS

 HARD TILES	 HARD STONES	 ARTIFICIAL STONES
-----------------------------------------------------------------------------------------------------	------------------------------------------------------------------------------------------------------	------------------------------------------------------------------------------------------------------------

CLAMSHELL PACKAGING

Hole Saws ≥Ø160mm are packaged in a carton box.



HOLE SAWS & MULTI-MATERIAL WHEELS



PRODUCTS	PAGE
XTREME FAST Hole Saw Arbors, Pilot Drills & Kit	378-379
XTREME FAST Hole Saw Adaptors	379
XTREME FAST Multi-Purpose Hole Saws	380-381
XTREME FAST Bi-Metal Plus Hole Saw	382-383
Diamond Dry Hole Saws for Drill	384
Diamond Dry Hole Saws for Angle Grinder	385-387
Multi-Materials Carbide Wheel	388
Multi-Materials Diamond Dry Wheel	389
Toolcase for XTREME FAST Hole Saws	390



CMT XTREME FAST AND PUSH&LOCK SYSTEMS: NEXT GENERATION HOLE SAW

XTREME
FAST

PUSH
& LOCK

1. One PUSH&LOCK arbor for all Hole Saw Series & Diameters

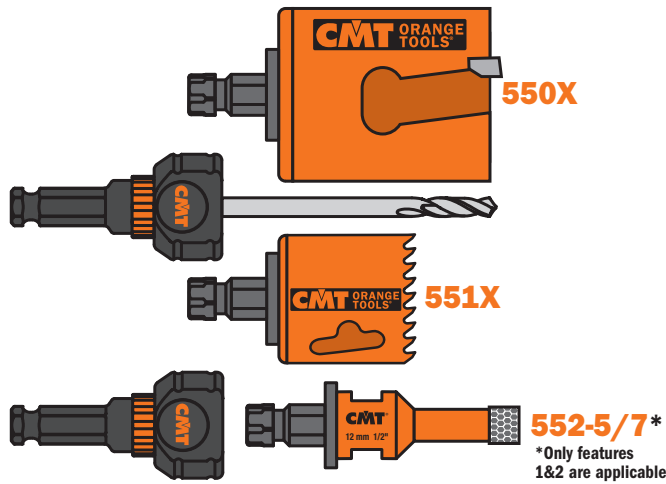

2. Change your Hole Saw with a simple PUSH&LOCK

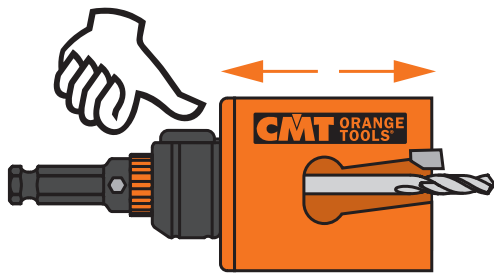

3. Release Plug with a push

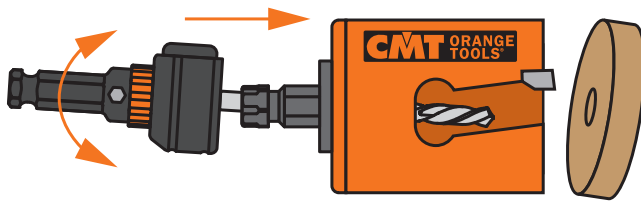

4. Enlarge the existing hole (Use adaptor set 550-PA05)

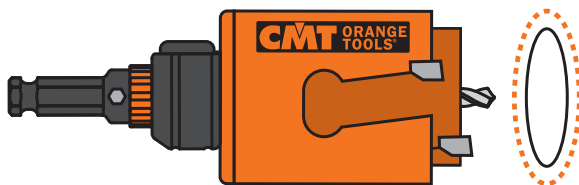

XTREME FAST & FASTX4 COMPATIBILITY (NEW & PREVIOUS SYSTEM)



Do you already have a CMT Hole Saw with the previous FASTX4 System? **NO PROBLEM, IT'S STILL GOOD TO GO!**



- 1.** Carefully and firmly secure your FAST4X Hole Saw. This will prevent damage to the tool and bodily injury while handling.
- 2.** Unscrew the adaptor attached to your previous FASTX4 Hole Saw.



- 3.** Replace the previous FASTX4 adaptor with the new XTREME FAST adaptor.

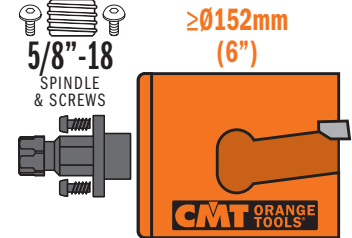
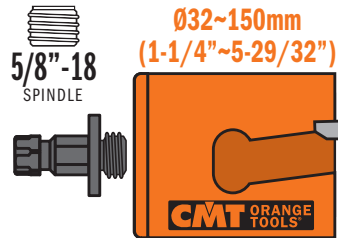
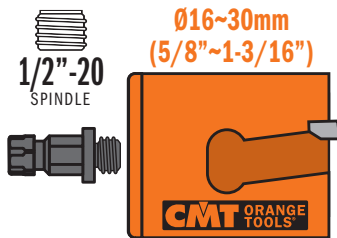

- 4.** Carefully tighten the new adaptor to the Hole Saw with a 13mm spanner.



- 5.** Your Hole Saw is now compatible with the new **PUSH & LOCK** **PUSH&LOCK** System. **YOU'RE GOOD TO GO!**



One **PUSH&LOCK** arbor for all Hole Saw Series & Diameters 

550-PH85

PUSH&LOCK arbor for **XTREME FAST** system, shank **HEX8.5mm** (11/32").
Compatible with chucks $\leq 25/64"$ (10mm).
HSS pilot drill (**550-PD02** included)

Suitable for Series:

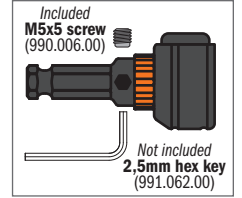

550-PH11

PUSH&LOCK arbor for **XTREME FAST** system, shank **HEX11mm** (7/16").
Compatible with chucks $\leq 1/2"$ (13mm). **HEAVY DUTY**.
HSS pilot drill (**550-PD02** included)

Suitable for Series:

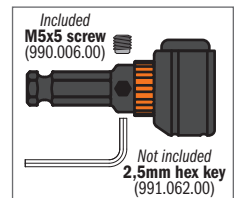

550-PHSD

PUSH&LOCK arbor for **XTREME FAST** system, shank **SDS PLUS**.
Compatible with **SDS PLUS** power tools.
HSS pilot drill (**550-PD02** included)

Suitable for Series:

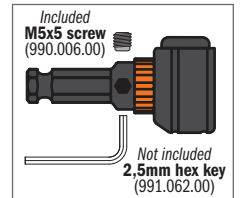

550-PD01

HW Pilot drill for **PUSH&LOCK** arbor, $\varnothing 7\text{mm}$ (17/64"), L=125mm (4-15/16").

Suitable for Series:



MATERIALS

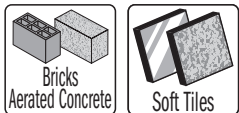

550-PD02

HSS Pilot drill for **PUSH&LOCK** arbor, $\varnothing 6.35\text{mm}$ (1/4"), L=125mm (4-15/16").

Suitable for Series:



MATERIALS



XTREME FAST system is compatible with all Hole Saw Series & Diameters **XTREME FAST**

550-PA01 (3pcs.)

XTREME FAST Adaptor 1/2"-20 for hole saw Ø16~30mm (5/8"~1-3/16")



Suitable for Series:



Ø16~30mm
(5/8"~1-3/16")



550-PA02 (3pcs.)

XTREME FAST Adaptor 5/8"-18 for hole saw Ø32~150mm (1-1/4"~5-29/32")



Suitable for Series:



Ø32~150mm
(1-1/4"~5-29/32")



550-PA03 (3pcs.)

XTREME FAST Adaptor 5/8"-18 for hole saw ≥Ø152mm (6")



Suitable for Series:



≥Ø152mm
(6")



550-PA04 (3pcs.)

XTREME FAST Adaptor M14 for hole saw series 552-5



Suitable for Series:



*Pilot drill of PUSH&LOCK arbor must be disassembled during use with this series

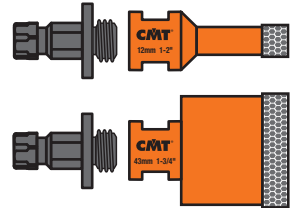

550-PA05 KIT FOR ENLARGMENT EXISTING HOLE (3pcs. LONG SPINDLE)

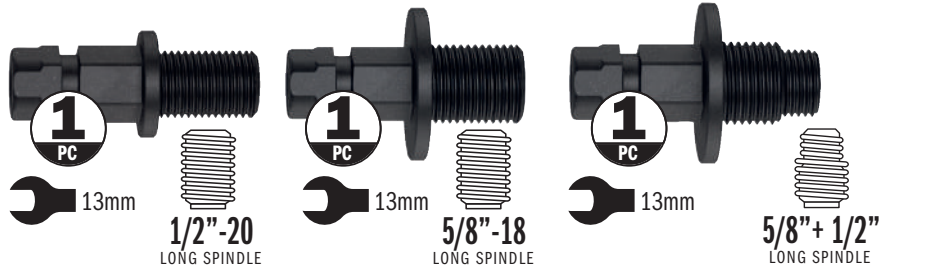

Suitable for Series:



Example of assembly for existing hole enlargement

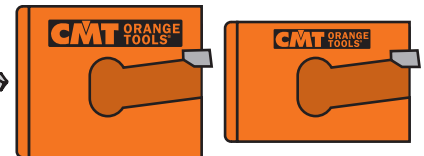

550-PA06 STARTER KIT (1pc. 550-PH85, 2pcs. 550-PA01, 3pcs. 550-PA02)



1 550-PH85
PCS

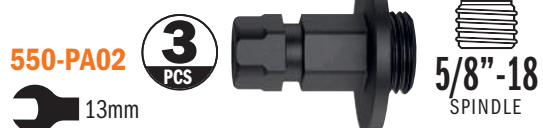
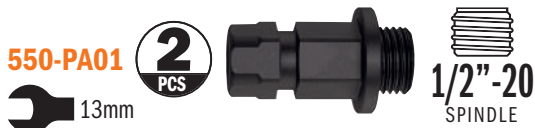

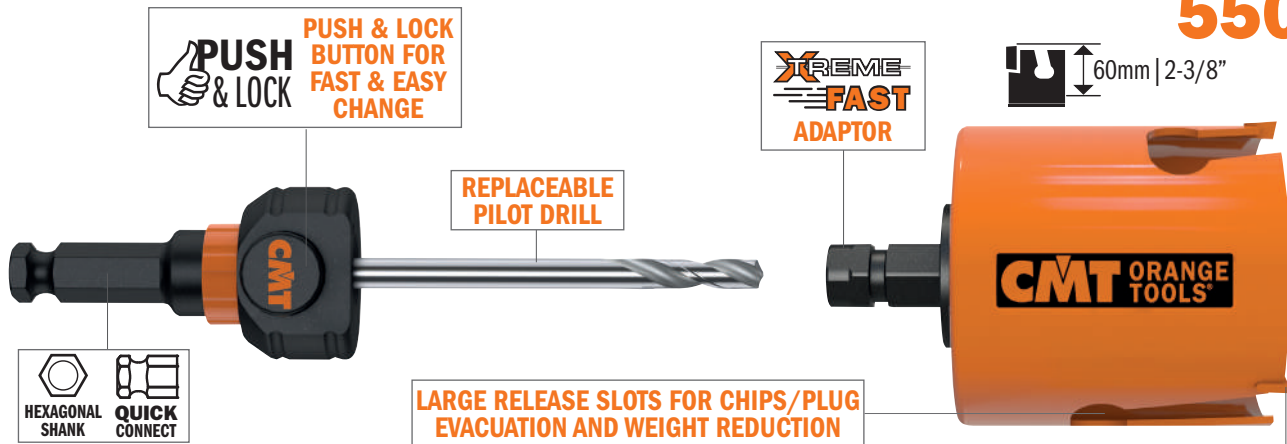

SECURED TOOTH TECHNOLOGY

Thanks to advanced technology, cutting teeth are securely anchored to body, which means they stand up better to hard materials and breakage.



FASTER 5X **10X LONGER LIFE**

CONSTRUCTION CARBIDE

Specially formulated construction carbide, used for cutting teeth provide 10X times longer cutting life and performs 5X faster than the standard hole saw.



MATERIALS



SPEED KILLS!

Operating at higher speeds than those indicated will shorten hole saw life and produce poor quality holes.

PRE-BORE:

For best results, always pre-bore with the pilot drill only.

NEVER USE HAMMER MECHANISM WITH THESE HOLESAWS!



APPLICATIONS: examples on wood, brick, plastic.



Multi-Purpose Hole Saws

new

CMT ORANGE TOOLS®

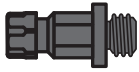

ALL HOLE SAWS 550X ARE EQUIPPED WITH AN XTREME FAST ADAPTOR

XTREME FAST

mm	D inches	Z	WOOD/PLYWOOD RPM*	MDF/LAMINATES RPM*	PLASTERBOARD RPM*	PLASTICS RPM*	BRICK/AERATED CONCRETE RPM*	SOFT TILES RPM*		ORDER NO.
19	3/4	1	2300	2300	2300	2100	900	700	10	550-019X
20	25/32	1	2200	2200	2200	2000	900	600	10	550-020X
22	7/8	1	2000	2000	2000	1800	800	600	10	550-022X
25	1	1	1800	1800	1800	1600	700	500	10	550-025X
29	1-1/8	1	1500	1500	1500	1400	600	400	10	550-029X
30	1-3/16	1	1500	1500	1500	1300	600	400	10	550-030X
32	1-1/4	1	1400	1400	1400	1200	500	400	10	550-032X
35	1-3/8	1	1300	1300	1300	1100	500	300	10	550-035X
38	1-1/2	2	1100	1100	1100	1000	400	300	10	550-038X
40	1-9/16	2	1100	1100	1100	1000	400	300	10	550-040X
44	1-3/4	2	1000	1000	1000	900	400	300	10	550-044X
48	1-7/8	2	900	900	900	800	300	200	10	550-048X
51	2	3	800	800	800	800	300	200	10	550-051X
52	2-1/16	3	800	800	800	700	300	200	10	550-052X
54	2-1/8	3	800	800	800	700	300	200	10	550-054X
56	2-3/16	3	800	800	800	700	300	200	10	550-056X
57	2-1/4	3	700	700	700	700	300	200	10	550-057X
60	2-3/8	3	700	700	700	600	300	200	10	550-060X
64	2-1/2	3	700	700	700	600	200	200	10	550-064X
65	2-9/16	3	700	700	700	600	200	200	10	550-065X
68	2-11/16	3	600	600	600	600	200	100	10	550-068X
70	2-3/4	3	600	600	600	500	200	100	10	550-070X
73	2-7/8	3	600	600	600	500	200	100	10	550-073X
76	3	4	500	500	500	500	200	100	10	550-076X
79	3-1/8	4	500	500	500	500	200	100	10	550-079X
80	3-5/32	4	500	500	500	500	200	100	10	550-080X
82	3-15/64	4	500	500	500	500	200	100	10	550-082X
83	3-1/4	4	500	500	500	400	200	100	10	550-083X
89	3-1/2	4	500	500	500	400	200	100	10	550-089X
92	3-5/8	4	400	400	400	400	200	100	10	550-092X
102	4	5	400	400	400	400	100	100	5	550-102X
105	4-1/8	5	400	400	400	300	100	100	5	550-105X
108	4-1/4	5	400	400	400	300	100	100	5	550-108X
111	4-3/8	5	400	400	400	300	100	100	5	550-111X
114	4-1/2	5	300	300	300	300	100	100	5	550-114X
118	4-5/8	6	300	300	300	300	100	100	2	550-118X
127	5	6	300	300	300	300	100	100	2	550-127X
133	5-1/4	6	300	300	300	300	100	100	2	550-133X
152	6	6	200	200	200	200	100	50	2	550-152X
160	6-5/16	7	200	200	200	200	100	50	1	550-160X
168	6-5/8	7	200	200	200	200	100	50	1	550-168X
185	7-5/16	8	200	200	200	200	100	50	1	550-185X
210	8-1/4	8	200	200	200	100	50	50	1	550-210X

*SUGGESTED RPM



APPLICATIONS
electric flush-mount case installation.

Example of commercial electric flush-mount boxes

mm	D inches	Z	WOOD/PLYWOOD RPM*	MDF/LAMINATES RPM*	PLASTERBOARD RPM*	PLASTICS RPM*	BRICK/AERATED CONCRETE RPM*	SOFT TILES RPM*		ORDER NO.
68 - 73	2-11/16 - 2-7/8	3+3	600	600	600	600	200	100	10	550-068CSX

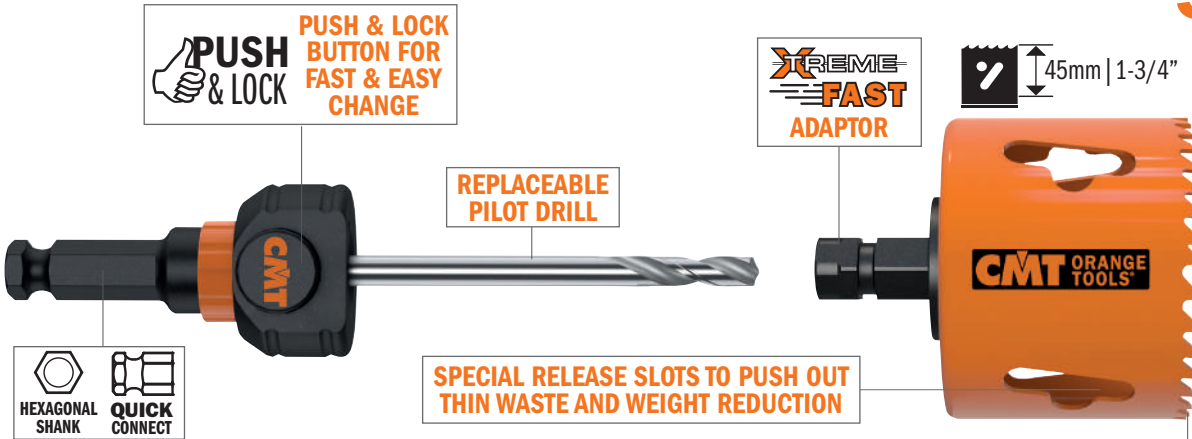

TOOTH DESIGN

Special tooth geometry with variable pitch (4~6 TPI) provides a smoother cut and better chip clearance preventing clogging and heat build-up. Teeth are alternate & side set to minimize binding and friction therefore requiring less feed pressure.

ALTERNATE & SIDE SET TEETH VARIABLE PITCH (4~6 TPI)



BI-METAL 8% COBALT

Teeth made with Bi-metal 8% Cobalt provide extreme results. Superior performance and 2X longer cutting life than the standard hole saw.



MATERIALS



COOLING LUBRICANT:

When drilling metals, lubrication serves several purposes:

- it cools the saw and workpiece
- it reduces heat and abrasion which shortens cutting life
- it helps remove swarf from the cutting surface
- it extends hole saw life by 500%.



SPEED KILLS!

Operating at higher speeds than those indicated will shorten hole saw life and produce poor quality holes.

FEED PRESSURE:

Always consider materials in use and project type. Apply sufficient feed pressure to aid proper chip removal. Reduce the pressure when hole saw becomes hot or if teeth start to clog. Insufficient feed pressure will lead to premature tooth dulling. Too much pressure will damage teeth.

PRE-BORE:

For best results, always pre-bore with the pilot drill only.

NEVER USE HAMMER MECHANISM WITH THESE HOLESAWS!



APPLICATIONS: examples on steel, sandwich material.



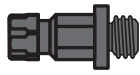

ALL HOLE SAWS 551X ARE EQUIPPED WITH AN XTREME FAST ADAPTOR



D		STAINLESS STEEL	CAST IRON	STEEL	ALUMINIUM	COPPER/BRASS	PLASTICS		ORDER NO.
mm	inches	RPM*	RPM*	RPM*	RPM*	RPM*	RPM*		
16	5/8	160	240	320	500	500	500	10	551-016X
19	3/4	140	200	280	420	420	420	10	551-019X
20	25/32	120	200	260	400	400	400	10	551-020X
22	7/8	120	180	240	360	360	360	10	551-022X
25	1	100	160	200	320	320	320	10	551-025X
27	1-1/16	80	140	180	300	300	300	10	551-027X
29	1-1/8	80	140	180	280	280	280	10	551-029X
30	1-3/16	80	120	160	260	260	260	10	551-030X
32	1-1/4	80	120	160	240	240	240	10	551-032X
35	1-3/8	60	100	140	220	220	220	10	551-035X
38	1-1/2	60	100	140	200	200	200	10	551-038X
40	1-9/16	60	100	120	200	200	200	10	551-040X
43	1-11/16	60	80	120	180	180	180	10	551-043X
44	1-3/4	60	80	120	180	180	180	10	551-044X
48	1-7/8	40	80	100	160	160	160	10	551-048X
51	2	40	80	100	160	160	160	10	551-051X
52	2-1/16	40	60	100	140	140	140	10	551-052X
54	2-1/8	40	60	80	140	140	140	10	551-054X
57	2-1/4	40	60	80	140	140	140	10	551-057X
60	2-3/8	40	60	80	120	120	120	10	551-060X
64	2-1/2	40	60	80	120	120	120	10	551-064X
65	2-9/16	40	60	80	120	120	120	10	551-065X
68	2-11/16	20	60	60	120	120	120	10	551-068X
70	2-3/4	20	40	60	100	100	100	10	551-070X
73	2-7/8	20	40	60	100	100	100	10	551-073X
76	3	20	40	60	100	100	100	10	551-076X
79	3-1/8	20	40	60	100	100	100	10	551-079X
83	3-1/4	20	40	60	80	80	80	10	551-083X
86	3-3/8	20	40	60	80	80	80	10	551-086X
89	3-1/2	20	40	60	80	80	80	10	551-089X
92	3-5/8	20	40	40	80	80	80	10	551-092X
102	4	20	40	40	80	80	80	5	551-102X
105	4-1/8	20	20	40	60	60	60	5	551-105X
108	4-1/4	20	20	40	60	60	60	5	551-108X
114	4-1/2	20	20	40	60	60	60	5	551-114X
127	5	20	20	40	60	60	60	2	551-127X
133	5-1/4	20	20	40	60	60	60	2	551-133X
140	5-1/2	10	20	20	40	40	40	2	551-140X
152	6	10	20	20	40	40	40	2	551-152X
168	6-5/8	10	20	20	40	40	40	1	551-168X

*SUGGESTED RPM

Diamond Dry Hole Saws

Diamond dry hole saws with continuous edge have been specially developed for professionals that need to drill in extremely tough materials like **HARD TILES (ceramic, gres, etc.)**, **HARD STONES (granite, marble, etc.)**, **ARTIFICIAL STONES (OKITE®, SILESTONE®, etc.)**, in which it is increasingly difficult to drill with conventional hole saws. Drilling other masonry materials is also possible, but it will reduce tool life. These hole saws guarantee excellent performance and superior lifetime!

552

MATERIALS



DIAMOND GRIT
Diamond grit featuring strong cubo-octahe-dral inclusion-free heat-resistant crystals, guarantees fast clean cutting and longer cutting life than the standard hole saw.



AVAILABLE WITH SHANK

HEXAGONAL SHANK

M14 SPINDLE

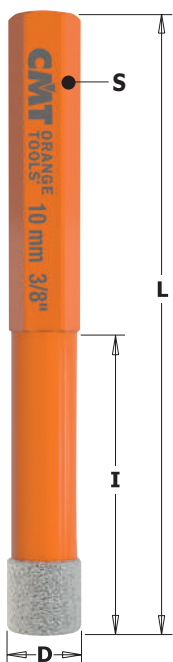

RPM 2200 ~ 4000*

552-0 FOR DRILL

mm	D inches	I mm	L mm	HARD TILES (CERAMIC & GRES) HARD STONES, ARTIFICIAL STONES	S		ORDER NO.
5	13/64	30	68	RPM 2200 ~ 4000 *	Hexagonal	10	552-005
6	1/4	30	68	RPM 2200 ~ 4000 *	Hexagonal	10	552-006
8	5/16	40	80	RPM 2200 ~ 4000 *	Hexagonal	10	552-008
10	3/8	40	80	RPM 2200 ~ 4000 *	Hexagonal	10	552-010
12	15/32	40	80	RPM 2200 ~ 4000 *	Hexagonal	10	552-012
14	9/16	40	80	RPM 2200 ~ 4000 *	Hexagonal	10	552-014
16	5/8	40	80	RPM 2200 ~ 4000 *	Hexagonal	10	552-016

*We recommend the use of a high speed drill (minimum 14V)

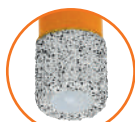

Filled with cooling wax
552-WAX



552-WAX COOLING & LUBRICATING WAX

While drilling, the wax will melt away (eliminated along with drilling waste). This facilitates cooling and lubrication. Replenish wax after every use (when still warm) to extend lifetime.
Jar 30ml. (1 fl.Oz)



PACK QTY. 10 pcs.



552-001-05

5 PIECE HOLE SAW SET

- 552-005 Ø5mm
- 552-006 Ø6mm
- 552-008 Ø8mm
- 552-010 Ø10mm
- 552-012 Ø12mm

PACK QTY. 10 pcs.

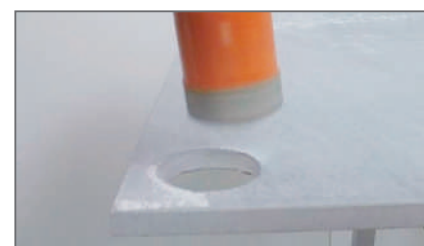
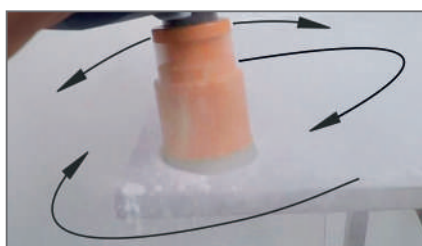
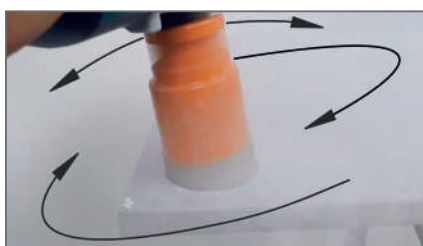
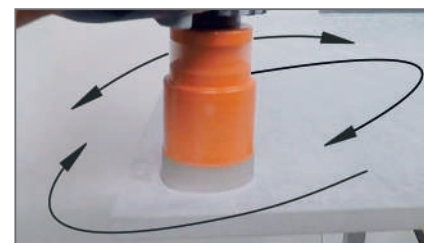
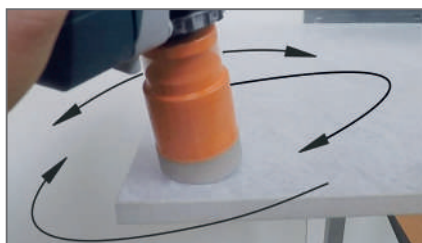
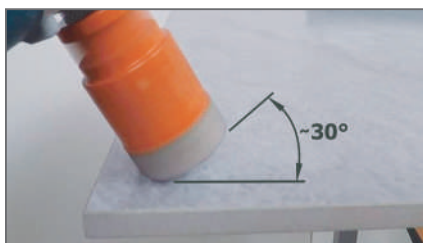

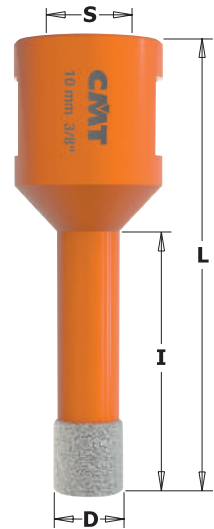

M14
SPINDLE



19mm
3/4"

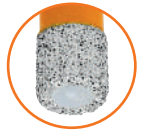

Filled with cooling wax **552-WAX** (until Ø16mm)



≥ Ø18mm without cooling wax

552-5 FOR ANGLE GRINDER

mm	D inches	I mm	L mm	HARD TILES (CERAMIC & GRES) HARD STONES, ARTIFICIAL STONES	S		ORDER NO.
5	13/64	35	60	MAX RPM 14000	M14	10	552-505
6	1/4	35	60	MAX RPM 14000	M14	10	552-506
8	5/16	35	60	MAX RPM 14000	M14	10	552-508
10	3/8	35	60	MAX RPM 14000	M14	10	552-510
12	1/2	35	60	MAX RPM 14000	M14	10	552-512
14	9/16	35	60	MAX RPM 14000	M14	10	552-514
16	5/8	35	60	MAX RPM 14000	M14	5	552-516
18	45/64	35	60	MAX RPM 14000	M14	5	552-518
20	13/16	35	60	MAX RPM 14000	M14	5	552-520
25	1	40	60	MAX RPM 14000	M14	5	552-525
28	1-1/8	40	60	MAX RPM 14000	M14	5	552-528
35	1-3/8	40	60	MAX RPM 14000	M14	5	552-535
43	1-3/4	40	60	MAX RPM 14000	M14	5	552-543
51	2	40	60	MAX RPM 14000	M14	5	552-551
55	2-3/16	40	60	MAX RPM 14000	M14	5	552-555
68	2-11/16	40	60	MAX RPM 14000	M14	5	552-568

Watch the video on



552-GUIDE

Drill Guide with Suction Cups - 7 holes
Ø4 - 5 - 6 - 7 - 8 - 10 - 12mm
Ø5/32" - 3/16" - 1/4" - 9/32" - 5/16" - 3/8" - 1/2"

PACK QTY. 10 pcs.



550-PA04

XTREME FAST Adaptor M14 (series 552-5) for PUSH&LOCK System (see page 5)



552-EX14

Hexagonal adaptor M14 (series 552-5) for drills



552-501-06

6 PIECE HOLE SAW SET

- 552-506 Ø6mm
- 552-508 Ø8mm
- 552-510 Ø10mm
- 552-512 Ø12mm
- 552-GUIDE
- 552-EX14

PACK QTY. 10 pcs.



552 RECOMMENDATIONS FOR USE:

Turn on drill to start tool rotation. Begin drilling at a 30° angle - this is the angle measured between the hole saw and the working surface. Cutting at an angle will prevent tool from slipping and facilitate precision centering. To improve stability during operation, use the working surface as leverage by resting the drill against it.

Continue the cut vertically, accompanying the tool in an orbital motion. This will favor better cooling and chip evacuation. (If you are using a guide, begin the cut vertically, then lift the guide and continue cutting in an orbital motion).

Remember, the hole saw is not a drill bit. Attempting to bore holes perpendicular to the work surface on a frequent basis will drastically reduce tool lifespan.

Using water as a cooling agent may help extend the life of the hole saw.

RPM SUGGESTED? High RPM values reduce the possibility of damaging/burning the diamond edge, ensuring a longer life.

NEVER USE HAMMER MECHANISM WITH THESE HOLESAWS!

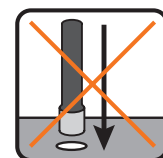

Diamond Dry Special Bits

new

CMT ORANGE TOOLS®

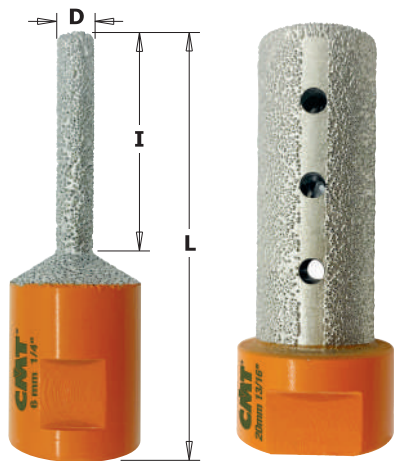

552-506M

552-520M

M14
SPINDLE



19mm
3/4"

552-M FOR ANGLE GRINDER

mm	D inches	I mm	L mm	S		ORDER NO.
6	1/4	35	65	M14	5	552-506M
20	13/16	50	65	M14	5	552-520M

APPLICATIONS:
for Milling, Enlarging, Shaping,
Countersinking on Existing Holes.

TIPS:
it can also be used to create lateral semicircular recesses
(for cables, pipes, etc.)



MATERIALS



550-PA04

XTREME FAST Adaptor M14
(series 552-5) for
PUSH&LOCK System (see page 5)



552-EX14

Hexagonal adaptor M14
(series 552-5) for drills



Diamond Dry Special Bits

new

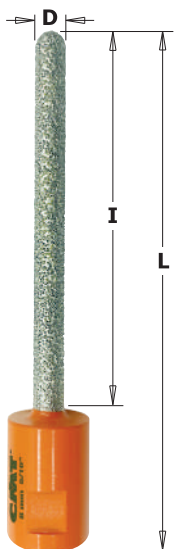

M14
SPINDLE



19mm
3/4"

552-508M FOR ANGLE GRINDER

mm	D inches	I mm	L mm	S		ORDER NO.
8	5/16	100	130	M14	5	552-508M

APPLICATIONS:
for Raking out Mortar Joint and for Milling,
Enlarging and Shaping Existing Holes.

TIPS:
suitable for raking out mortar joints and removing bricks.



MATERIALS



550-PA04

XTREME FAST Adaptor M14
(series 552-5) for
PUSH&LOCK System (see page 5)



552-EX14

Hexagonal adaptor M14
(series 552-5) for drills



Diamond Dry Special Bits

new

CMT ORANGE TOOLS

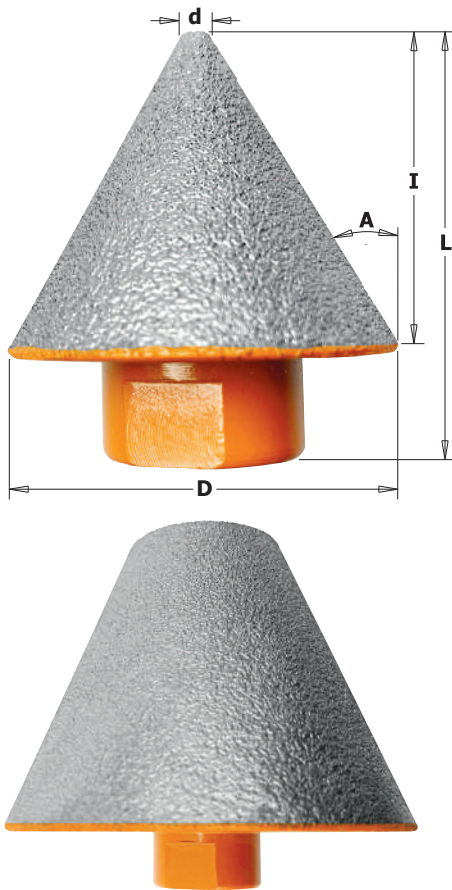

M14
SPINDLE



552-CS FOR ANGLE GRINDER

d		D		I	A	S	ORDER NO.
mm	inches	mm	inches	mm			
5	13/64	35	1-3/8	30	65°	M14	552-535CS
30	1-3/16	70	2-3/4	50	45°	M14	552-570CS

APPLICATIONS:
for Countersinking on Existing Holes.



MATERIALS



550-PA04

XTREME FAST Adaptor M14
(series 552-5) for
PUSH&LOCK System (see page 5)



552-EX14

Hexagonal adaptor M14
(series 552-5) for drills



Diamond Dry Wheels

new

552-115 FOR ANGLE GRINDER **CURVED**

D		B		GRIT	ORDER NO.
mm	inches	mm	inches		
115	4-1/2	22,2	7/8	medium-fine	552-115-01
115	4-1/2	22,2	7/8	coarse	552-115-02

APPLICATIONS:
for Smoothing, Trimming, Chamfering.



MATERIALS



552-115 FOR ANGLE GRINDER **FLAT**

D		S	GRIT	ORDER NO.
mm	inches			
115	4-1/2	M14	medium-fine	552-115-03
115	4-1/2	M14	coarse	552-115-04

APPLICATIONS:
for Smoothing, Trimming, Chamfering.

M14
SPINDLE





MULTI-MATERIALS

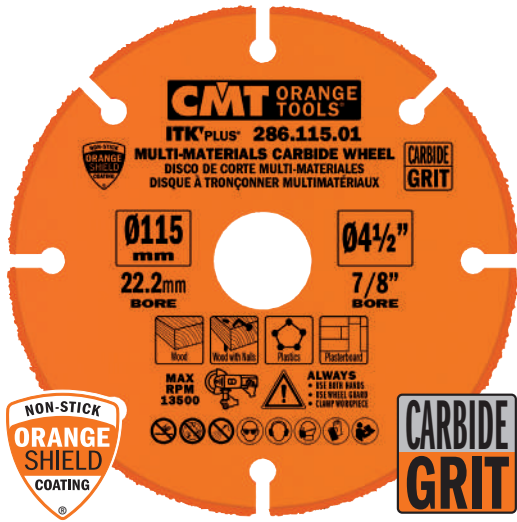

286 ITK PLUS®

D mm	B mm		ORDER NO.
115	22,2 (+9,5+15,87)	10	286.115.01
125	22,2 (+20+15,87)	10	286.125.01
230	22,2	5	286.230.01

MACHINES



ANGLE GRINDER



MINI CORDLESS CIRC. SAW

Blade diameter compatibility is contingent on machine type.

MATERIALS



WOOD



WOOD/WOOD & NAILS

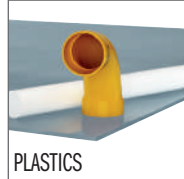

PLASTICS



PLASTERBOARD



APPLICATIONS: examples on wood, wood & nails and plastics.





MULTI-MATERIALS

286.61 ITK⁺PLUS[®]



D mm	B mm		ORDER NO.
115	22,2 (+9,5+15,87)	10	286.115.61
125	22,2 (+20+15,87)	10	286.125.61

MACHINES



Blade diameter compatibility is contingent on machine type.

MATERIALS

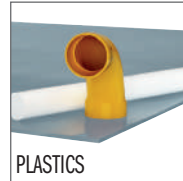

APPLICATIONS: examples on bricks, hard stone and artificial stone.





**XTREME
FAST**

**PUSH
& LOCK**



The toolcase is provided empty, image is purely indicative.
A toolcase can contain 1 PUSH&LOCK arbor, 1 Pilot Drill and relative number of XTREME FAST Hole Saws.
The number of Hole Saws to be contained is dependent on diameter.



UP TO
11
HOLE SAWS

UP TO
24
HOLE SAWS

UP TO
63
HOLE SAWS

DESCRIPTION	ORDER NO.
Toolcase SMALL - Up to 11 Hole Saws	03.01.0531
Toolcase MEDIUM - Up to 24 Hole Saws	03.01.0532
Toolcase LARGE - Up to 63 Hole Saws	03.01.0533

**FOR
FREE!**

Toolcase **SMALL** (empty) is yours free when you purchase any **10PCS** of the **XTREME FAST** series.
Toolcase **MEDIUM** (empty) is yours free when you purchase any **20PCS** of the **XTREME FAST** series.
Toolcase **LARGE** (empty) is yours free when you purchase any **40PCS** of the **XTREME FAST** series.

POWER TOOLS, JIGS & ACCESSORIES

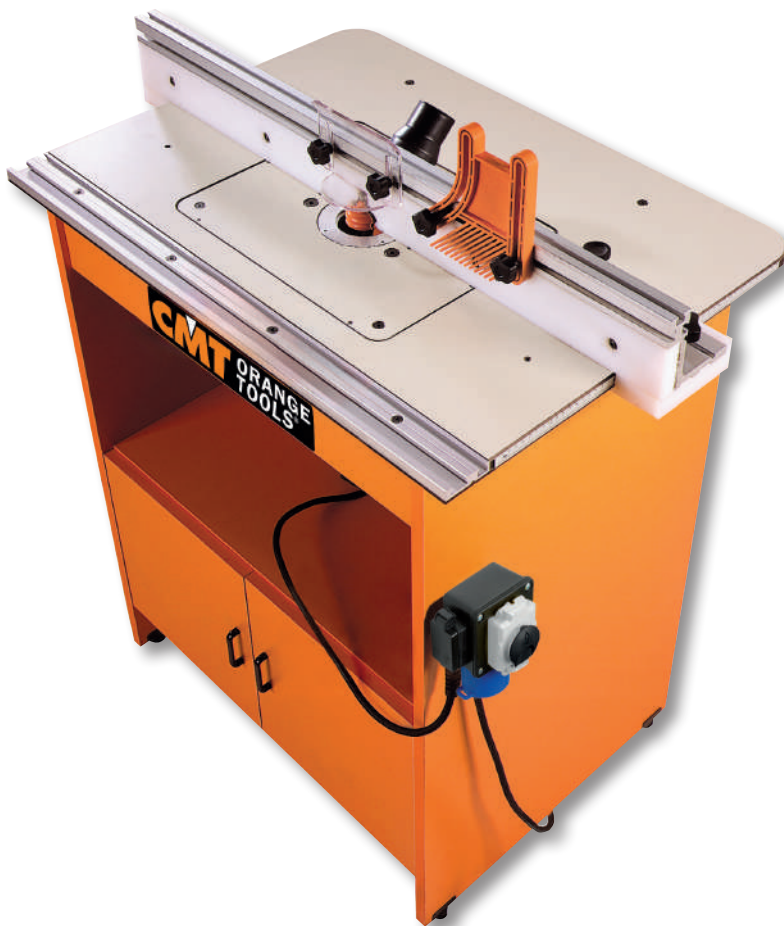

PRODUCTS	PAGE
Routers & Trimmer	392-394
Oscillating Multi-Tools	395
Router Tables	396-397
Small Stock Holder & Tabletop Accessories	398
Pocket-Pro Joinery System	399
Professional Straight Edge Clamps	400
Adjustable Precision Router Dado Jig	401
Flexible Templates for Routing	402
Corner Radius Router Template	402
Contour Duplicator Gauge	403
Adjustable Corner Frame Clamps	403
Universal Dovetail Jig	404-405
Inlay & Template Guide Kit	406
Kitchen Worktop Jig	407
Universal Boring Template and Jig	408-409
Universal Hinges Boring Systems	410-412
Torque Screwdriver & Wrench	413
3D Router Carver System	414-416
Bowl & Tray System	417
Digital Height Gauge	418
Digital Moisture Meter	418
Digital Angle Gauge & Finder	419
Edge Banding Jigs	420
Diamond Whetstones	421
Bench Block Set	422
Bit Organizer	422
Tool Cleanear & Lubricant	423
Glooves	424
CMT Professional Tool Bag	424
Carpenter Pencil & Ink Pen	424
Deep Hole Mechanical Marker	425



1000W Precision Router

CMT8E

PLUG TYPE: F
Power cord length: 2m.

ELECTRONIC SPEED CONTROL
Variable from 8.000 - 20.000 RPM.

ON/OFF POWER SWITCH
Retracting cover to prevent accidental power on.

SAFETY GUARDS
Provides maximum protection around cutting zone.

MICRO WINDER
Turn to adjust the cutting depth micrometrically.

BRUSH REPLACEMENT
Change worn brushes quickly and easily.
Spare part: **CMT8E-046**

PLUNGE LOCK LEVER
To fasten the plunge at the desired position.

BASEPLATE MOUNTING KNOB
For fast setup and removal from extended baseplate.



- TECHNICAL DETAILS:**
- Power 1000W
 - Input 220/240V (50/60Hz)
 - No load speed 8.000-20.000 RPM
 - Plunge range 0-59mm
 - Base plate hole Ø77mm
 - Collet diameter range Ø6-12,7mm
 - Power cord length 2m
 - Tool weight 3,8 Kg

- Standard Equipment**
- CMT8E Precision Router 1000W
 - Extended Baseplate & Fence
 - Table Height Winder (Spare part: **CMT8E-300**)
 - Collet Spanner (Spare part: **CMT7E-119**)
 - Ø8 & Ø12mm Collets
 - 3 Screws (1/4 UNC) (Spare part: **990.468.00**)
 - 1 Year Warranty
 - Instructions manual

Optional

Clamping nuts and collets for **CMT8E** and **CMT7E**

DIAMETER	ORDER NO.
D = 6mm	796.660.00
D = 6,35mm	796.664.00
D = 8mm	796.680.00
D = 10mm	796.700.00
D = 12mm	796.720.00
D = 12,7mm	796.727.00



Included

EXTENDED BASEPLATE & FENCE
Provides excellent control for free plunge use and circle cutting.



DUAL MODE

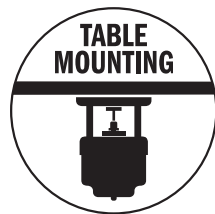

DESCRIPTION	ORDER NO.
1000W Precision Router	CMT8E

2400W Precision Router



CMT7E

ELECTRONIC SPEED CONTROL

Variable from 8.000 - 21.000 RPM.

PLUG TYPE: F

Power cord length: 3m.



BRUSH REPLACEMENT

Change worn brushes quickly and easily.

Spare part: **CMT7E-028**



ON/OFF POWER SWITCH

Retracting cover to prevent accidental power on.



SAFETY GUARDS

Provides maximum protection around cutting zone.

TURRET STOPS

3 preset cut depths with mm scale.

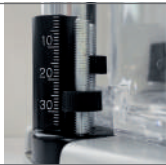

BASEPLATE MOUNTING KNOB

For fast setup and removal from extended baseplate.



NO VOLTAGE RELEASE (NVR) SAFETY SYSTEM

Prevents the motor from automatically restarting after a power interruption.

MICRO WINDER

Turn to adjust the cutting depth micrometrically.

REMOVABLE PLUNGE SPRING

It must be removed when table mounting.



PLUNGE SELECTION BUTTON

To switch from winder handle to free plunge mode.

WINDER HANDLE

Turn to adjust the cutting depth.

PLUNGE LOCK LEVER

To fasten the plunge at the desired position.

TECHNICAL DETAILS:

- Power 2400W
- Input 220/240V (50/60Hz)
- No load speed 8.000-21.000 RPM
- Plunge range 0-68mm
- Base plate hole Ø79mm
- Collet diameter range Ø6~12,7mm
- Power cord length 3m
- Tool weight 6,5 Kg

Standard Equipment

- CMT7E Precision Router 2400W
- Extended Baseplate & Fence
- Table Height Winder (Spare part: **CMT7E-130A**)
- Collet Spanner (Spare part: **CMT7E-119**)
- Ø8 & Ø12mm Collets
- 4 Screws (1/4 UNC) (Spare part: **990.467.00**)
- NVR Bypass Key
- 1 Year Warranty
- Instructions manual (10 languages)

Optional

Clamping nuts and collets for **CMT8E** and **CMT7E**

DIAMETER	ORDER NO.
D = 6mm	796.660.00
D = 6,35mm	796.664.00
D = 8mm	796.680.00
D = 10mm	796.700.00
D = 12mm	796.720.00
D = 12,7mm	796.727.00



Check out **CMT7E** on



DUAL MODE

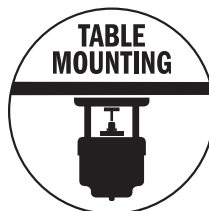

DESCRIPTION	ORDER NO.
2400W Precision Router	CMT7E

Included

EXTENDED BASEPLATE & FENCE

Provides excellent control for free plunge use and circle cutting.



TABLE HEIGHT WINDER

Permits quick and easy above-the-table height adjustment of router bit, when the router is table-mounted.

Spare part: **CMT7E-130A**

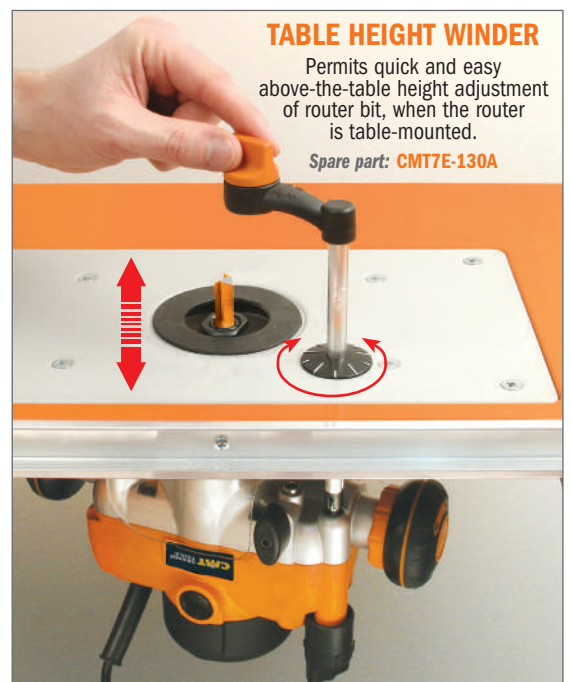

550W Trimmer

CMT10

PLUG TYPE: F

Power cord length: 2m.



BRUSH REPLACEMENT

Change worn brushes quickly and easily.

Spare part: **CMT10-30**

Included



CMT10-54
Ø10mm guide bush

ERGONOMIC DESIGN

Better control during one-handed operation.

FAST TOOL REPLACEMENT

EXTENDED BASEPLATE & FENCE

QUICK-CLAMP SYSTEM

Easily remove motor from the base.

FINE DEPTH ADJUSTMENT

Aluminium-embossed scale for accurate setting of the desired routing depth.



TRIMMER GUIDE WITH ROLLER PREVENTS MARRING

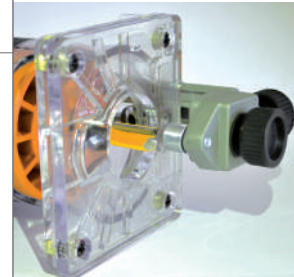

DESCRIPTION		ORDER NO.
550W Trimmer	8	CMT10



Watch the video on



TECHNICAL DETAILS:

- Power..... 550 Watt
- Input..... 220/230V (50/60Hz)
- No load speed 32.000 RPM
- Plunge range 0-24mm
- Base plate hole Ø34mm
- Collet diameter range Ø6-8mm
- Power cord length 2m
- Tool weight..... 1,6 Kg

Standard Equipment

- CMT10 Trimmer 550W
- Extended Baseplate & Fence
- Trimmer guide
- Guide bush
- 2 wrenches for easy cutter replacement (12 and 17mm)
- Ø6mm, Ø6,35mm and Ø8mm collet
- 1 year warranty
- Instruction manual

Spare parts



CMT10-16A
Base plate



CMT10-17
Clamping nut



CMT10-18 Collet Ø6mm
CMT10-18A Collet Ø6,35mm
CMT10-18B Collet Ø8mm



CMT10-30
Pair of carbon brushes

300W Oscillating Multi-Tools

CMT11

ELECTRONIC SPEED CONTROL
Variable from 11.000 - 21.000 RPM (1-6).



PLUG TYPE: F
Power cord length: 3m.



FAST LOCK



MULTI MATERIALS & APPLICATIONS:



- GRINDING
- SAWING
- JOINT OPENING
- PLASTIC CUTTING
- CARPET REMOVAL
- PLUNGE CUTTING
- WOOD CUTTING
- CUTTING LAMINATE SHEETS
- TUBE LENGTH TRIMMING
- NAIL CUTTING

TECHNICAL DETAILS:

- Power300 Watt
- Input220/230V (50/60Hz)
- No load speed11.000~21.000 RPM
- Power cord length3m
- Tool weight.....1,5 Kg

Standard Equipment

- CMT11 Oscillating Multi-tool 300W
- Handle
- Vacuum hose
- Instruction manual
- Plastic carry case

Included



HANDLE **VACUUM HOSE**



DESCRIPTION		ORDER NO.
300W Oscillating Multi-Tools	5	CMT11

Sturdy reusable carrying case



Professional Router Table

999.110.00

CE Compliant

CMT7E+PRO

Our quality bits have been designed for you, the professional craftsman, to allow you to confidently work at your best. CMT now offers even more possibilities with our professional router table: the perfect place to combine your skills and CMT quality. The professional router table system has a strong and sturdy MDF laminate work surface measuring 80x60x2,5cm for easy mobility when working. This free standing table sits at a comfortable height of 90cm on solid high gauge steel legs and weighs 26,5 Kg. The plate is already pre-bored for CMT routers **CMT7E** but is adaptable to all brands and models of routers on the market. Plate can also fit any router bit up to 98mm in diameter. Choose from our wide range of bits, including multi profile and molding bits or even kitchen bit set. Work easily and safely on this table!

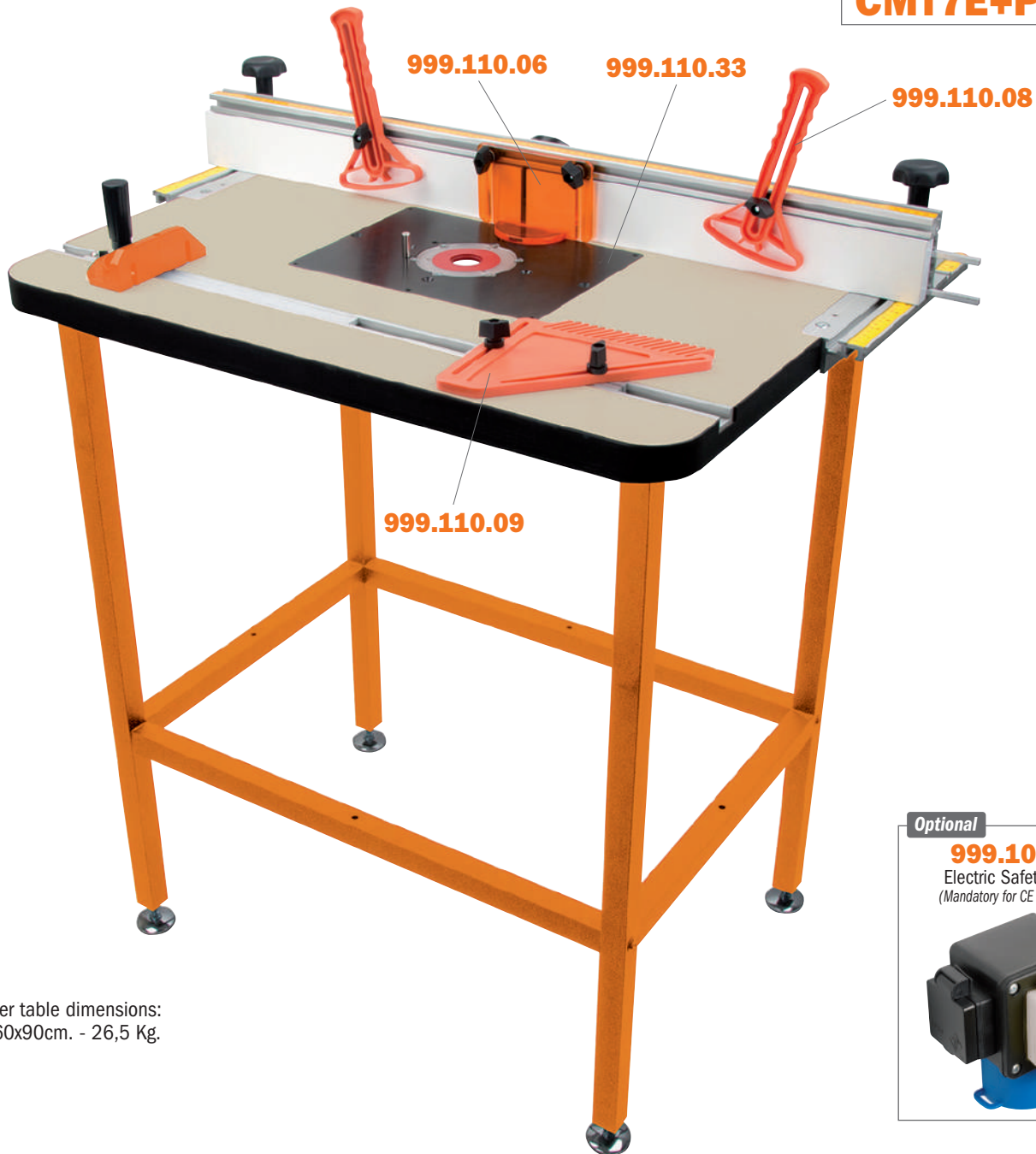

Optional

999.100.11
Electric Safety Switch
(Mandatory for CE Compliance)



Router table dimensions:
80x60x90cm. - 26,5 Kg.

DESCRIPTION	ORDER NO.
Professional Router Table System	999.110.00
999.110.00 + CMT7E + 999.100.11 (CE Compliant: Only when purchase together)	CMT7E+PRO
Spare parts:	
CMT7E Prebored Plate (306x229x8mm) with 2 reduction rings Ø32-66mm	999.110.33
Safety Shield	999.110.06
Standing Spring Press	999.110.08
Moulded ABS Featherboard	999.110.09
Mitre Gauge	999.110.10
Optional:	
Universal Plate (unbored for non-CMT routers) with 2 reduction rings Ø32-66mm (306x229x8mm)	999.110.03
CMT8E Prebored Plate with 2 reduction rings Ø32-66mm (306x229x8mm)	999.110.34
Electric Safety Switch (Mandatory for CE Compliance)	999.100.11
4 Screws for CMT7E assembly on Professional Router Table System	990.467.00

Industrio Routing System

CMT has further improved the Industrio Routing System into an impressive instrument featuring new accessories such as a phenolic worktop, integrated aluminum scales and an improved fence.

CMT ORANGE TOOLS®

999.500.01

Check out
Industrio Routing System on

YouTube

CE Compliant

CMT7E+IND

999.501.18

CMT7E Prebored Plate & Aluminium Rings Ø103-69,5mm.



999.110.10

Mitre Gauge



999.501.06

Dual and post-guard makes freehand work safer.



999.501.07

Moulded ABS featherboard. Setup on table and in fence slots.

999.502.10

Central section of the fence is removable and shapeable.

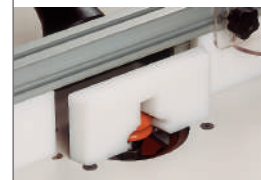

999.502.34

Router Centering Device (8-12mm) for the drilling of housing bores with non-CMT routers.



999.500.01 includes: (also sold separately)

• 999.501.09 Phenolic Worktop

Boasting a phenolic worktop is 20 mm thick and is far sturdier and more resistant to wear and warping than regular melamine surfaces. Features aluminum scales on both ends for quick and easy fence setup. Fast and easy bit change, CMT's useful bent wrench 991.006.00 (optional) allows you to replace the bits from above quickly and easily. CMT7E Prebored plate: 298x374x12 mm (11-3/4" x 14-3/4" x 15/32"). Weight: 15 Kg.

Includes: 999.501.18

• 999.501.10 Adjustable Aluminum Guide Fence

To be used as a traditional fixed or pivoting fence. Quick adjusting clamps on both ends make adjustments a breeze. Features a sub-fence made of high-density white plastic, with a central section both removable and shapeable, guaranteeing an ultra-smooth feeding surface. Weight: 8.5 Kg.

Includes: 999.501.06, 999.502.10, 999.502.34

• 999.501.03 Orange Sturdy Melamine Cabinet

Made of 20mm thick melamine, this cabinet is easy to assemble. Weight: 32.5 Kg.

• 999.501.07 Moulded ABS Featherboard

• 999.110.10 Mitre Gauge

Router table dimensions:
79x59x93cm. - 55 Kg.

Optional

999.100.11

Electric Safety Switch
(Mandatory for CE Compliance)

Optional

Bent wrenches for bit replacement.

17mm**991.005.00**

21mm**991.002.00**

22,2mm**991.004.00**

23,8mm**991.003.00**

24mm991.006.00*

28,6mm**991.001.00**

*For CMT7E and CMT8E routers



DESCRIPTION

Industrio Routing System (with prebored plate for CMT7E)
999.500.01 + CMT7E + 999.100.11 + Additional 999.501.07 (CE Compliant: Only when purchase together)

Optional:

Universal Plate (unbored for non-CMT routers) with Ø103-69,5mm aluminium rings

CMT8E Prebored Plate with Ø103-69,5mm aluminium rings

Aluminium Reduction Rings (pair) Ø103-69,5mm

Electric Safety Switch (Mandatory for CE Compliance)

4 Screws for CMT7E assembly on Industrio Routing System

ORDER NO.

999.500.01

CMT7E+IND

999.501.26

999.501.27

999.501.05N

999.100.11

990.467.00

Small Stock Holder

By far, handling small stock on your router table is probably one of the most difficult challenges any professional woodworker has to face! Keeping all ten fingers attached to your hands is definitely a priority. This is why the CMT Small Stock Holder is an absolute necessity in the workshop! It safely ensures proper stabilization of smaller work pieces throughout the routing process. The handle grips fitted with comfy silicone inserts keep fingers and hands a safe distance from the blade while the anti-slip lining on both the center and right side base prevents slippage and ensures your work-piece stays put! Fully adjustable and easy to control, the CMT Small Stock Holder can manage small stock up to **216mm. (8-1/2")** in width. The perfect little jig for detail-oriented jobs!

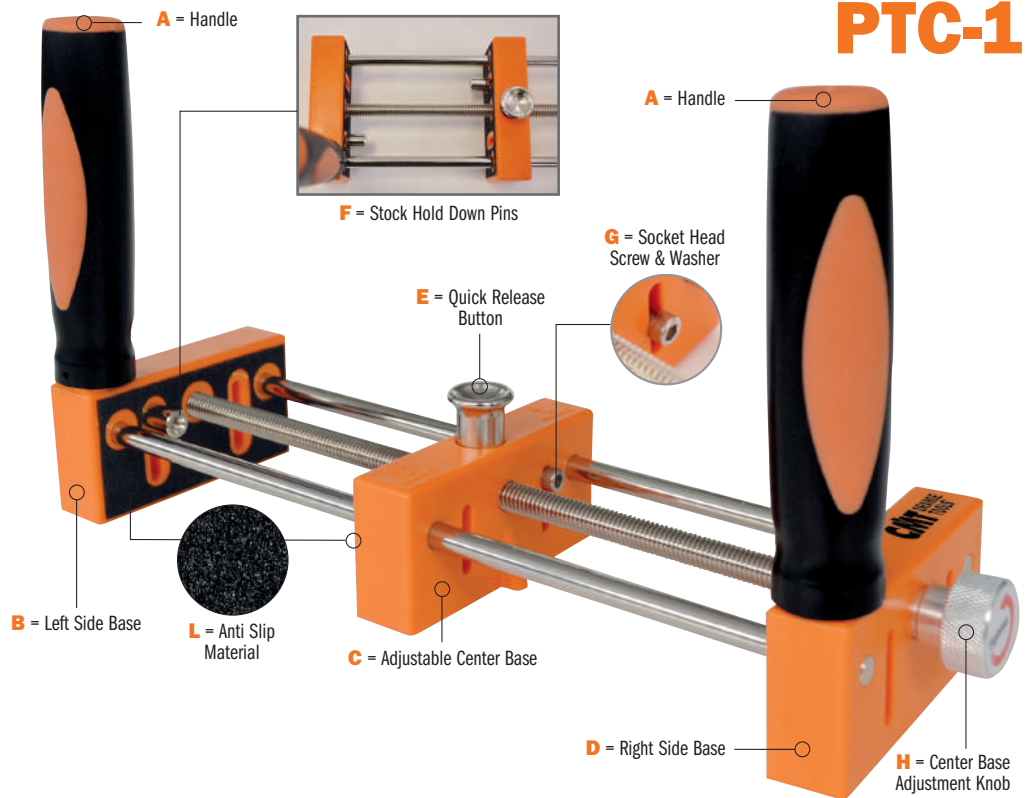

PTC-1

DESCRIPTION	ORDER NO.
Small Stock Holder	PTC-1

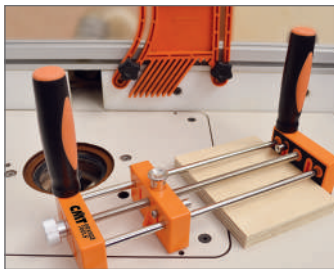

1. Lie the Small Stock Holder flat on the work surface. Slide the Hold Down Pins [F] to the top of the slotted holes. Insert the small stock piece between the Adjustable Centre [C] and Left-Side Bases [B]. The end of your small stock piece should lie flat and snugly up against the Left-Side Base. The end must also extend outwards in front of the Small Stock Holder a minimum distance of half the diameter of the router bit in use.



2. Press the Quick Release Button [E]. Slide the Adjustable Centre Base [C] over until it fits snugly against the small stock piece. Release the Quick Release Button. In the image, a "sacrificial piece" is being used to prevent "tear-out". Loosen Hold Down Pins [F] with the Hex Key Wrench provided. Slide Hold Down Pins down until resting firmly against the small stock piece. Tighten pins with Hex Wrench. Rotate Centre Base Knob [H] to further secure your small stock piece.

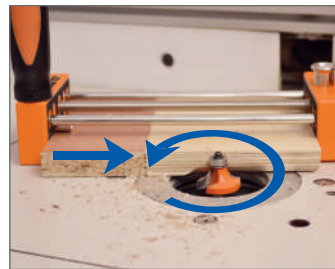

3. Adjust the height of your router bit. When you're ready, power on your router. Take hold of the Small Stock Holder Handles [A], slowly feed your small stock piece into the router opposite to the router bit rotation and always in contact with the router bit bearing guide. When finished routing, press the Quick Release Button [E] and slide the Adjustable Centre Base [C] over so you can remove the small stock piece.

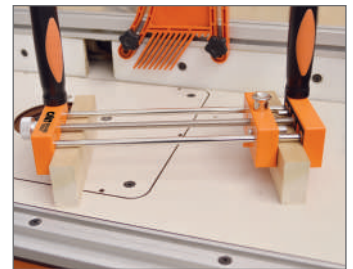

4. Need to rout stock thicker than the Small Stock Holder? Follow setup instructions carefully. Create an "outrigger" - cut a piece of stock, which will act as a stabilizer, the same thickness as the piece you are working on. Attach the "outrigger" securely to the Right-Side Base [D] using pan-head screws (not included) that will fit through the slotted holes. In this way, your work piece and the Small Stock Holder will remain stable during the routing process.

Tabletop Accessories



999.110.42
Push block



999.110.41
Push stick

999

DESCRIPTION	ORDER NO.
Push stick	999.110.41
Push block	999.110.42



Pocket-Pro Joinery System

PPJ-002

For fast, easy and accurate cabinet & furniture construction. Designed by CMT and professional cabinetmakers, this new system allows you to make rock-solid pocket hole joints in stock 12,7mm (1/2") to 41,3mm (1-5/8") thick with unprecedented speed and accuracy.

The heart of the Pocket-Pro System is our unique moulded jig, which features hardened drill bushings and an interlocking two-piece design. Sliding the jig up or down enables you to adjust the stock thickness in preset 1,6mm (1/16") increments without test joints or measurements! If you have used other pocket hole jigs you will be familiar with many joint applications, but you will benefit from many Pocket-Pro System advantages.

For example:

- some jigs require adding or removing various parts of the jig to join different stock thicknesses. With the Pocket-Pro System you simply have to adjust the interlocking jig up or down for the full range of joints 12,7mm (1/2") to 41,3mm (1-5/8") thick;
- other jigs require frequent repositioning of the depth stop collar for different joint styles. CMT's Pocket-Pro Joinery System allows you to make most of the adjustments leaving the stop collar in the same position of the drill bit;
- plus, with CMT's Pocket-Pro System you can quickly adjust the location of the pocket in relation to the end of your workpiece to create a stronger joint by using longer screws, or to leave more "meat" in the joint.

Check out the Pocket-Pro Joinery System today. Easy enough for beginners and accurate enough for professional workers, it is the world's most versatile pocket hole jig.



541.095.00 + 515.001.51



999.505.05



990.101X30



999.505.10



999.505.08

DESCRIPTION OPTIONAL	ORDER NO.
500 fine screws L=31,7mm (1-1/4")	990.101X500
500 coarse screws L=31,7mm (1-1/4")	990.102X500
500 fine screws L=38,1mm (1-1/2")	990.103X500
500 coarse screws L=38,1mm (1-1/2")	990.104X500
Face clamp swivel pad	999.505.06
L=76mm (3") square drive screwdriver bit	999.505.07
Phenolic insert plate (for Pocket-Pro)	999.505.04

DESCRIPTION	ORDER NO.
Pocket-Pro Joinery System set	PPJ-002
Set contains:	
Pocket-Pro main parts	999.505.10
Toggle clamp	999.505.05
Ø9,5mm (3/8") step drill bit	515.001.51
Ø9,5mm (3/8") depth collar for step drill bit	541.095.00
L=152mm (6") Square drive screw driver bit	999.505.08
30 screw L=31,7mm (1-1/4")	990.101X30

Optional



999.505.04

Phenolic insert plate (for Pocket-Pro)



999.505.06

Face clamp with swivel pad



Watch the video on

YouTube

ENJOY EASY POCKET HOLE JOINERY!

BUILD ALMOST ANYTHING!

1. Set jig & bit depth

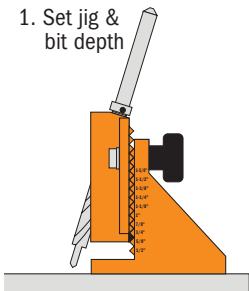

2. Clamp & drill stock

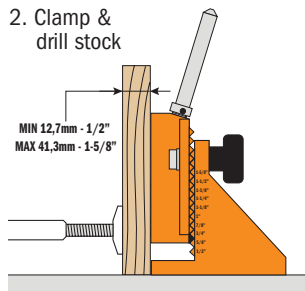

3. Assemble the joint!

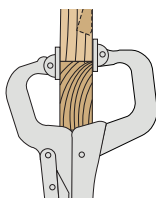

Face Frames

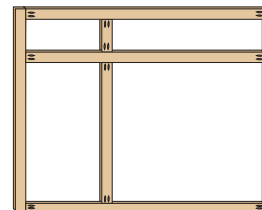

Cabinets and more!

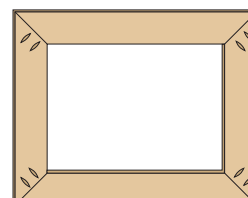
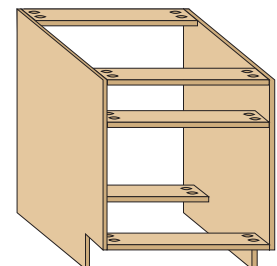

Picture Frames

Professional Straight Edge Clamps

Used as a fence for your bandsaw, drill press or even as an auxiliary fence on your router table or table saw, CMT's professional straight edge clamps represent a two-in-one tool, allowing you to either use them as an edge guide, or to easily clamp your boards or any object for woodworking. Available in different sizes. Here are the main features:

- Made of extruded aluminium for easy carriage and enhanced durability.
- Light, yet more rigid than any other clamps on the market.
- Measuring scales, low-profile jaws, built-in T-tracks on the top allowing the use of accessories or jigs.
- Either single or back-to-back clamps.

Low-profile clamps allow for accurate cuts, dados and grooves. In addition they properly work as an auxiliary fence on your drill press or router table. Sturdy jaws hold your workpiece to the full length of the clamp without any side-to-side play. Back-to-back clamps with the suitable accessories also let you manage your woodworking operations with a lot of versatility. Adjustable scale and two T-tracks allow you to use many accessories.

DESCRIPTION	ORDER NO.
Professional Straight Edge Clamp 610mm	PGC-24
Professional Straight Edge Clamp 915mm	PGC-36
Professional Straight Edge Clamp 1270mm	PGC-50

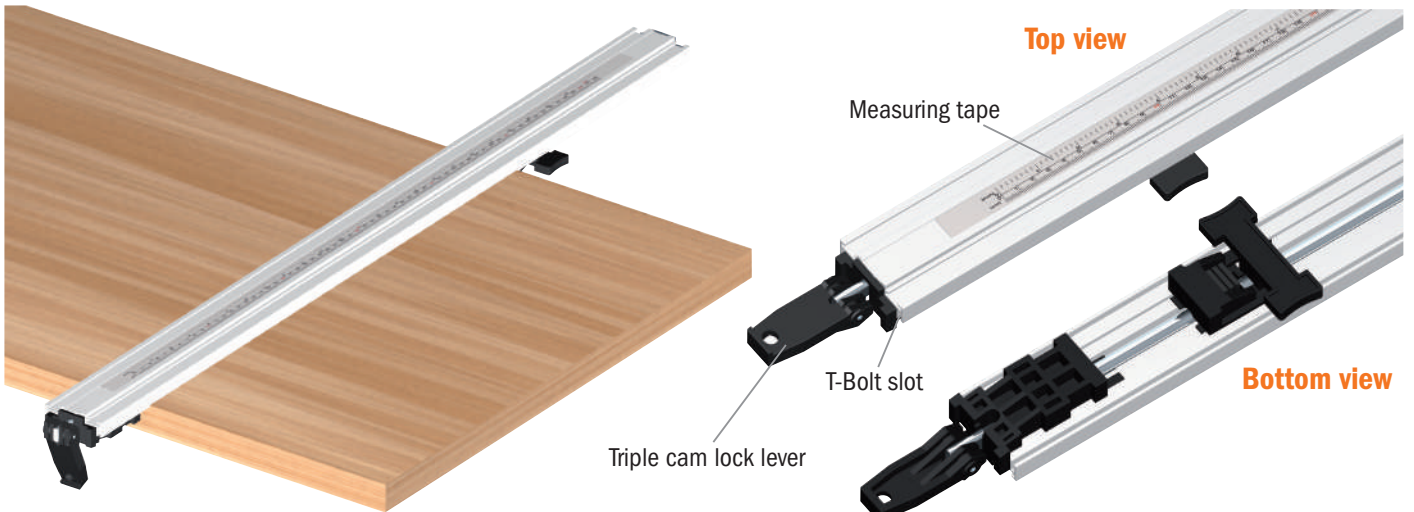

Back-to-Back Connectors for Straight Edge Clamps (optional)

Lay two more straight edge clamps on the back of the other pair of straight edge clamps and secure them by using your back-to-back connectors.

Fasten the bottom jaw pads to the table top and clamp wood with the top jaw pads. Thanks to the low profile jaws your work surface is never obstructed.

The back-to-back straight edge clamps can also be taken apart for making two separate clamps.

DESCRIPTION	ORDER NO.
Back to Back Connectors for straight edge clamps (8 Pieces)	PGC-B2B

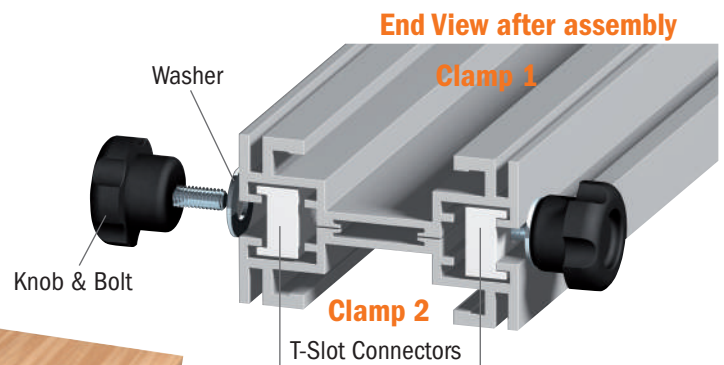

Adjustable Precision Router Dado Jig

The perfect tool for crafting grooves, dadoes, and joints. Easy to use and fully adjustable. You can create dadoes of any size using the same router by simply increasing the number of passes you make. Sturdy construction built to last. Smooth rolling steel rollers are ideal for easy maneuverability and stress-free handling. Compatible with almost any router equipped with 1-3/16" (30mm) bushings or by using the Bushing Template Guides included. (bore baseplate sold separately). Guarantees clean precise dadoes.

FITS THE MOST POPULAR ROUTERS

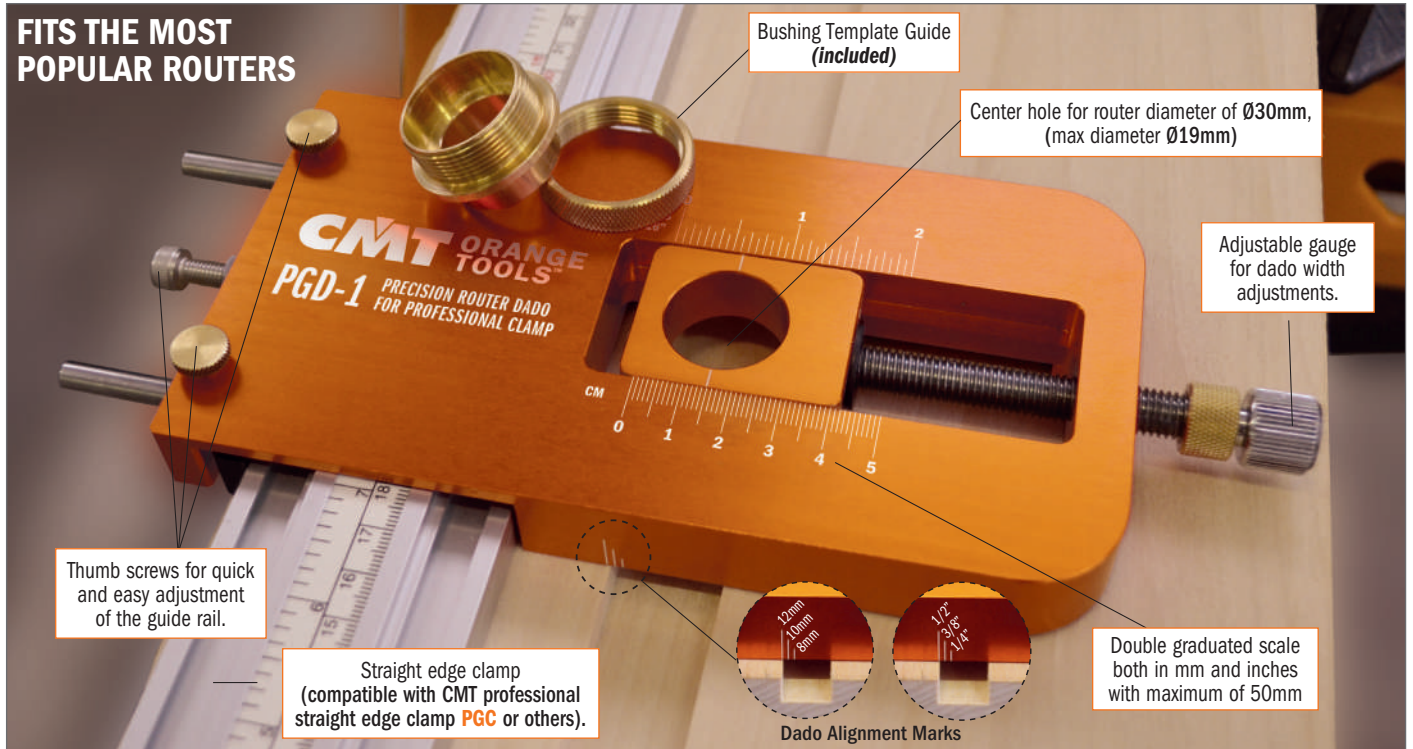

Prepare your router: Install the guide bushing rings into the bore baseplate and then attach it as the base for your router. Select and insert your router bit.

Prepare the Adjustable Guide Rail & Straight Edge Clamp: Position both the adjustable straight edge clamp and then the adjustable precision router dado jig onto your workpiece. Then using the adjustable thumb screws, secure it. Once assembled, ensure that the adjustable precision dado jig slides freely.



Insert your router into the center hole of the adjustable precision router dado jig.

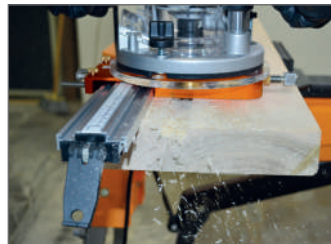

Set your cutting depth by raising or lowering the bit until desired depth is reached. Determine the starting point of the cut you wish to make by using the Dado Alignment Marks on the long sides (width) of the Adjustable Precision Router Dado Jig which indicates the outside edge of the dado cut closest to the straight edge clamp (12-10-8mm front, 1/2", 3/8", 1/4" back).



Holding onto your router in position, power on and begin making the cut by pushing forward and back on the straight edge clamp using the precision router dado jig as a guide. Makes impeccable grooves and dadoes along the length of your workpiece.



For creating dadoes that exceed router width, using the adjustable gauge, simply select the desired width on the graduated scale.

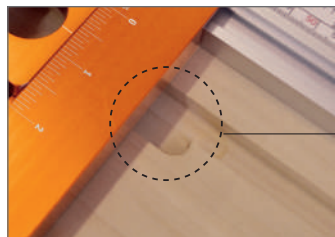

Make as many passes necessary to obtain the desired dado width.

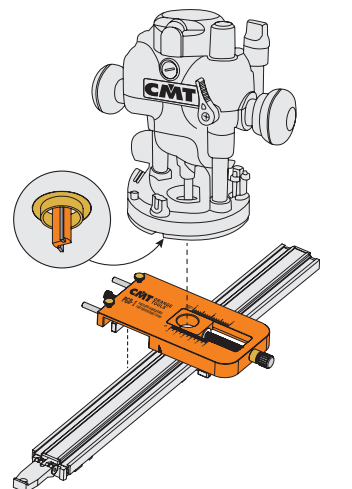
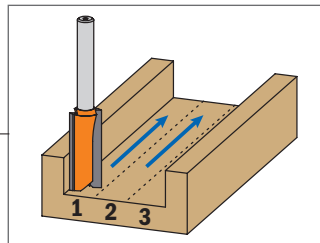

RECOMMENDED* (not included)

- Universal Router Base **899.000.01** or
- 899.000.02** Prebored base for **CMT7E/CMT8E**

*Not required for routers with 30mm (1-3/16") bushing guide

RECOMMENDED (not included)

- PGC** Straight Edge Clamp with graduated scale (pag. 400)

DESCRIPTION	BOXES	ORDER NO.
Adjustable Precision Router Dado Jig	10	PGD-1

Flexible Templates for Curved & Arched Routing

The CMT flexible template is easy to screw on any kind of wooden panels, MDF or chipboard for creating forms, arcs and curved elements easily and rapidly. In order to fix your template you can use countersunk screws, which are widely available on the market. The CMT template is made of a highly-resistant flexible plastic, which can be tied in knots without any risk of ruining or reducing flexibility.

Screw your template to the edge of the panel and follow its shape and rout the border on the guide ring. The template is suitable for manual feed on routers, router tables and spindle moulders. Rout easily, safely and accurately to make multiple forms such as arcs, curved elements and cut-out forms. Mark the edge of your form precisely and screw it onto a previously-placed panel from underneath.

If you rout with a guide ring mounted onto your spindle moulder, keep your hands a safe distance behind the template. Two different profiles in three lengths are available. Please notice that the smallest profile features a short radius, whereas the larger profile features a larger opening in case of flat and long curves.

- Special plastic without any plasticizer.
- Made in Germany.
- Lasts more than 10 years!

Check out the **Flexible Template** on

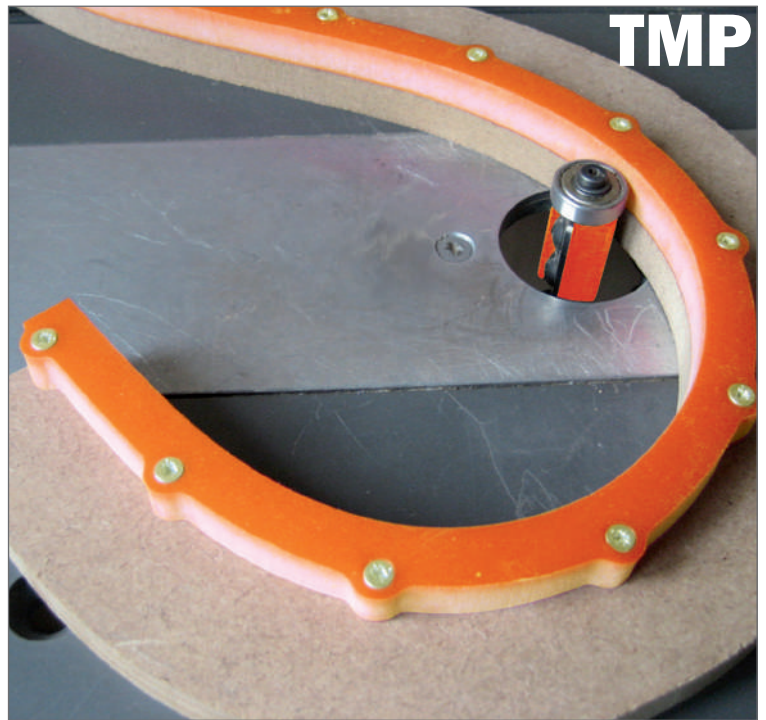

DESCRIPTION	L mm	ORDER NO.
Flexible template for routing 18x18mm	1000	TMP-1000
Flexible template for routing 12x12mm	1200	TMP-1200
Flexible template for routing 18x18mm	2000	TMP-2000 ■

■ Until stock last

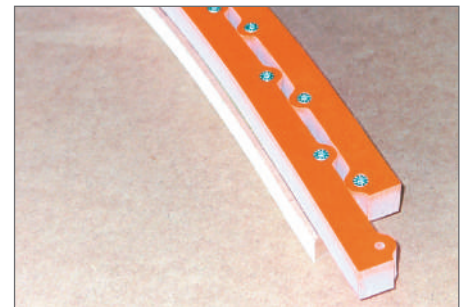
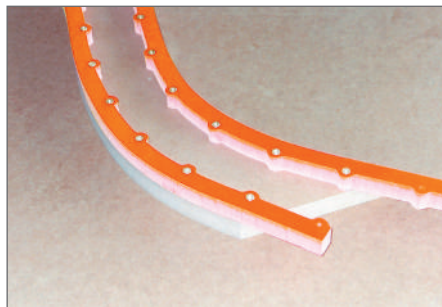
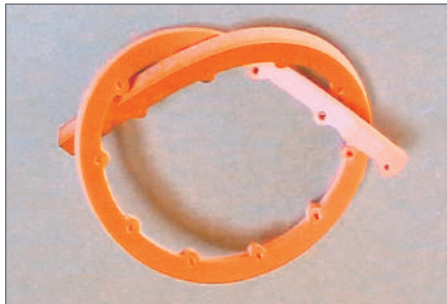

12 Corner Radius Router Template Set from 3mm to 25mm

Our useful 3-piece corner radius template set includes 8mm thick acrylic templates that will allow you to make 12 different radii (4 per template) by using a flush trim or a pattern bit (sold separately). Included with the templates you will also find 4 alignment pins and 4 wood screws.

Use the pins to align the template onto your workpiece, then use the four wood screws provided to secure it. Remove the alignment pins and use the bit to cut the corner of your workpiece to the same radius as the template.

RADIUS	
mm	inches
3	1/8"
5	3/16"
6	1/4"
8	5/16"
10	3/8"
11	7/16"
12	1/2"
14	9/16"
16	5/8"
19	3/4"
22	7/8"
25	1"



DESCRIPTION	ORDER NO.
12 Corner Radius Router Template	TMP-R12
Set contains:	
12 Different Radii (3 templates)	
4 Alignment Pins	
4 Wood Screw	

Contour Duplicator Gauge

For precision tracing of shapes, even curved, in a variety of materials. Easy sliding calipers designed to mold and duplicate any form: pipes, columns, tubing, regular and irregular walls, baseboards, crown molding, door and window framework. For use on applications such as tile, wood, wood derivatives, composite, porcelain, ceramic, vinyl, flooring for easy tracing, fitting and installation. No guesswork, no patch jobs, less waste!

CDG-001

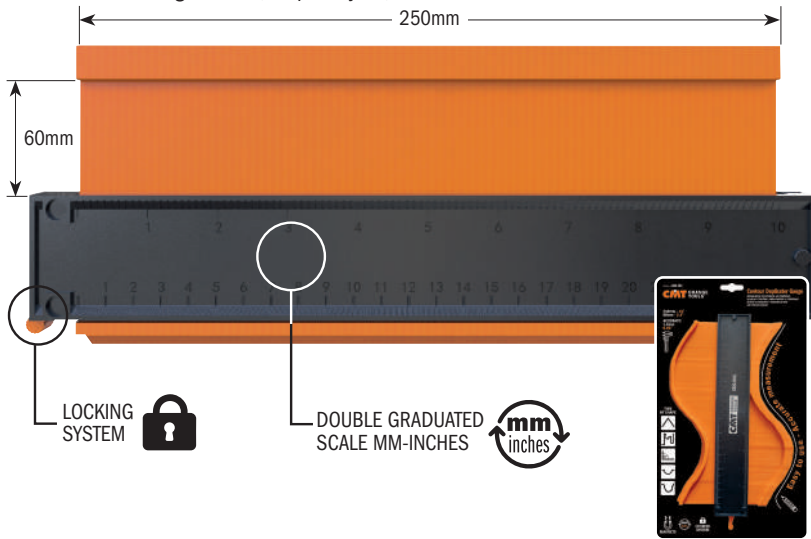

DESCRIPTION	BOXES	ORDER NO.
Contour Duplicator Gauge	5	CDG-001

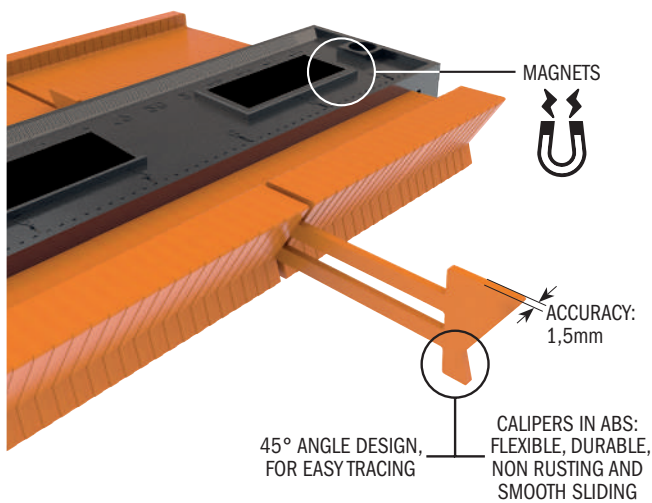

TYPE OF SHAPE

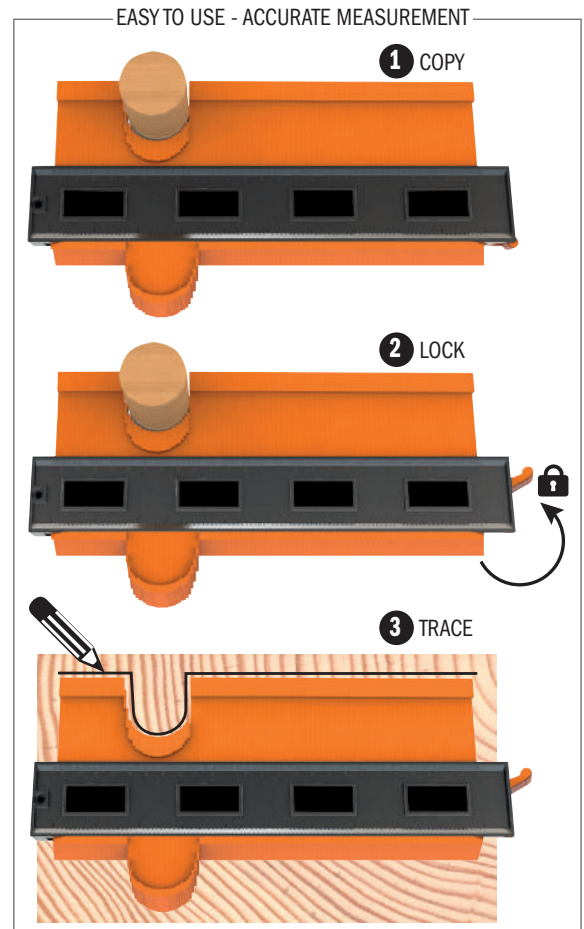
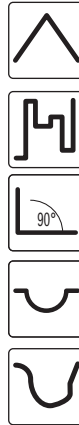

Adjustable Corner Frame Clamps

CMT Adjustable Corner Frame Clamps will easily create the perfect 90° angle or handy T-joints typical in shelving, cabinets and frame applications using boards of variable thicknesses from 6 to 25.4 mm. These clamps allow you to work independently, and above all, hands-free so you can glue, dry-fit, nail, screw, or square your joint securely and accurately - just like a professional. The special design allows you to immobilize the panels from the inside (hex key) and from the outside (knob) according to your project needs. Set up is easy as 1-2-3: position the clamp, twist the knob and presto! Equal pressure is instantly applied on each side of the corner and you have a perfectly squared 90° joint! Made of sturdy and durable plastic material, the clamp features a double graduated scale in mm/inches for a broad range of adjustments.

CFC-002



DESCRIPTION	ORDER NO.
2 pcs. Adjustable Corner Frame Clamps 100x100x35	CFC-002

Universal Dovetail Jig

Dovetail joints give a touch of craftsmanship to your work, but many woodworkers avoid these joints, because of their apparent complexity. CMT's new 305mm dovetail jig is the fast easy solution! Thanks to precise templates, permanent stops and easy adjustments, we have taken the "tinkering" out of dovetail joinery. Simply clamp your workpiece in with the edges against the factory-set stops, set your bit depth and then you are ready to rout. Rest assured, we haven't cut corners on quality either. This jig features a rugged steel body, templates, stops and clamping bars that together produce perfect long-lasting joints for all your woodworking needs. The jig accepts stock from 11mm to 25mm in thickness and is capable of crafting a variety of joints with the available templates. The jig comes with a template for 12.7mm half blind joints as well as a template guide. Optional templates are available for through dovetail and box joints.

CMT300

305mm max length
11~25mm joint thickness

Check out **CMT300** on



CLOSED SECTION STEEL CLAMPING BAR

RUGGED STEEL TEMPLATE



FACTORY-PRESET STOP

STRONG STEEL BODY SOLID SUPPORT

EASY-GRIP CLAMPING KNOB

Standard equipment

- Standard Ø12,7mm silver blind template **CMT300-T128**
- Ø15,8x4mm template guide **899.005.00**

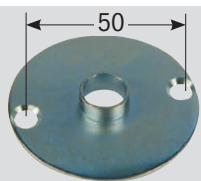

DESCRIPTION	ORDER NO.
Universal Dovetail Jig	CMT300

IMPORTANT TIP



HW DOVETAIL BITS (not included):

- 718.127.11** D=12,7mm A=14° S=6mm
- 818.128.11** D=12,7mm A=14° S=6,35mm
- 918.127.11** D=12,7mm A=14° S=8mm
- 818.628.11** D=12,7mm A=14° S=12,7mm



Will the template fit my router?

Standard template guide features two prebored holes with 50mm center-to-center distance and attaches via two screws. Many routers are compatible with this design. However, if yours is not, choose from the list of universal router bases here below:

Universal router bases

- For Ø8 and Ø12mm shank
- For Ø6,35 and Ø12,7mm shank
- Prebored plastic router plate for **CMT7E** and **CMT8E**

ORDER NO.

- CMT300-SB1**
- CMT300-SB2**
- CMT300-SB**

Here's how it works:

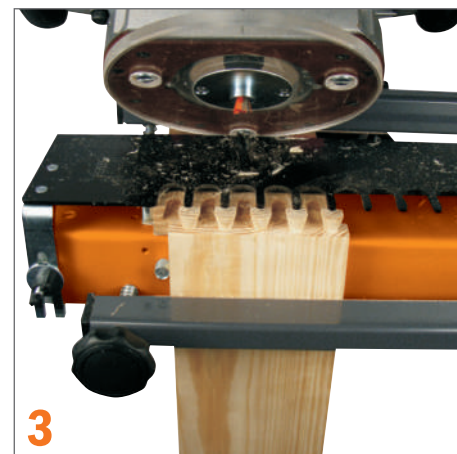

Half Blind Template **CMT300-T064**

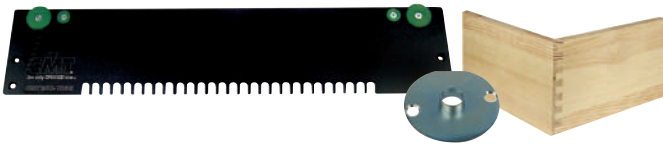

TEMPLATE LENGTH mm	DOVETAIL SIZE mm	THICKNESS mm	COLOUR	ORDER NO.
300	6,3	8 ~ 12	green	CMT300-T064

Supplied with Ø7,8x4mm precision guide

To be used with CMT dovetail router bits:

Ø6x8mm HW bit (Ø6mm shank)

Ø6,35x8,3mm HW bit (Ø6,35mm shank)



899.003.00

718.060.11

818.064.11

Through Dovetail Templates **CMT300-T129 - CMT300-T190**

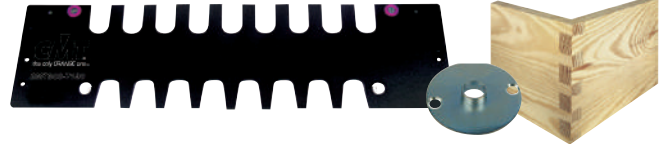

TEMPLATE LENGTH mm	DOVETAIL SIZE mm	THICKNESS mm	COLOUR	ORDER NO.
300	12,7	8 ~ 20	brown	CMT300-T129

Supplied with Ø11,1x4mm precision guide

To be used with CMT straight router bits:

Ø8x25mm HW bit (shank Ø6,35mm)

Ø8x30mm HW bit (shank Ø8mm)

To be used with CMT dovetail router bits:

Ø12,7x20mm HW bit (Ø6,35mm shank)

Ø12,7x20mm HW bit (Ø8mm shank)



899.004.00

811.081.11

912.080.11

818.129.11

918.129.11

Box Joint Templates **CMT300-T080 - CMT300-T127**

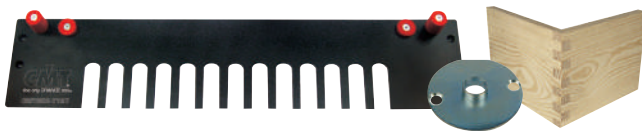

TEMPLATE LENGTH mm	DOVETAIL SIZE mm	THICKNESS mm	COLOUR	ORDER NO.
300	8	8 ~ 20	blue	CMT300-T080

Supplied with Ø11,1x4mm precision guide

To be used with CMT straight router bits:

Ø8x25mm HW bit (Ø6,35mm shank)

Ø8x30mm HW bit (Ø8mm shank)



899.004.00

811.081.11

912.080.11

TEMPLATE LENGTH mm	DOVETAIL SIZE mm	THICKNESS mm	COLOUR	ORDER NO.
300	12,7	8 ~ 20	red	CMT300-T127

To be used with CMT straight router bits:

Ø12,7x30mm bit HW (Ø6,35mm shank)

Ø12,7x30mm bit HW (Ø8mm shank)

Ø12,7x25mm bit HW (Ø12,7mm shank)



812.127.11

912.127.11

811.627.11

TEMPLATE LENGTH mm	DOVETAIL SIZE mm	THICKNESS mm	COLOUR	ORDER NO.
300	19	15 ~ 22	violet	CMT300-T190

Supplied with Ø22x4mm precision guide

To be used with CMT straight router bits:

Ø12,7x30mm HW bit (Ø6,35mm shank)

Ø12,7x30mm HW bit (Ø8mm shank)

Ø12,7x25mm HW bit (Ø12,7mm shank)

To be used with CMT dovetail router bits:

Ø19x22mm HW bit (Ø6mm shank)

Ø19x22mm HW bit (Ø6,35mm shank)

Ø19x22mm HW bit (Ø8mm shank)

Ø19x22mm HW bit (Ø12mm shank)

Ø19x22mm HW bit (Ø12,7mm shank)



899.006.00

812.127.11

912.127.11

811.627.11

718.190.11

818.190.11

918.190.11

918.690.11

818.690.11

Precision guide for router:

DIAMETER	ORDER NO.
7,8 x 4mm	899.003.00
11,1 x 4mm	899.004.00
15,8 x 4mm	899.005.00
22 x 4mm	899.006.00
27 x 6mm	899.008.00
30 x 6mm	899.007.00

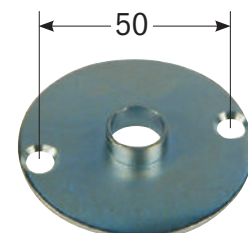

HERE ARE A FEW OF THE BEAUTIFUL DOVETAIL JOINTS YOU CAN PRODUCE USING CMT BITS

Half blind



CMT300 - T064
CMT300 - T128 (INCLUDED with CMT300)

Box joint

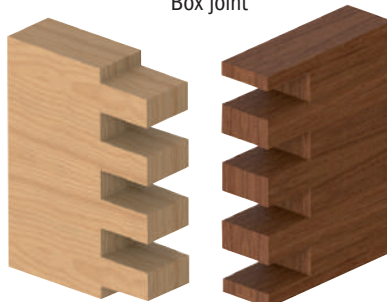

CMT300 - T080
CMT300 - T127

Through dovetail



CMT300 - T129
CMT300 - T190

Inlay Kit

The components of this kit include a spiral cutter or a straight cutter (sold separately) with a diameter of 3mm and 3.2mm and a 6mm and 6.35mm attachment respectively. The interchangeable brass rings allow you to create the cavity of your choice on the workpiece. The instruction manual shows in detail all the steps of the process. This kit offers endless decorative possibilities (toys, puzzles and lettering). The spiral cutter is recommended for use on MDF while the straight cutter is best for natural wood.



DESCRIPTION	ORDER NO.
Inlay kit with 3,2mm (1/8") HWM spiral bit (Ø6,35mm shank)	899.051.00
Inlay kit with 3,2mm (1/8") HWM straight bit (Ø6,35mm shank)	899.052.00
Solid brass template guide	899.001.00
Universal router base	899.000.01
Router base for CMT7E/CMT8E	899.000.02
3,2mm (1/8") HWM spiral bit (Ø6,35mm shank)	192.001.11
3,2mm (1/8") HWM straight bit (Ø6,35mm shank)	812.032.11
3mm HWM spiral bit (Ø6mm shank)	192.630.11
3mm HWM straight bit (Ø6mm shank)	712.030.11

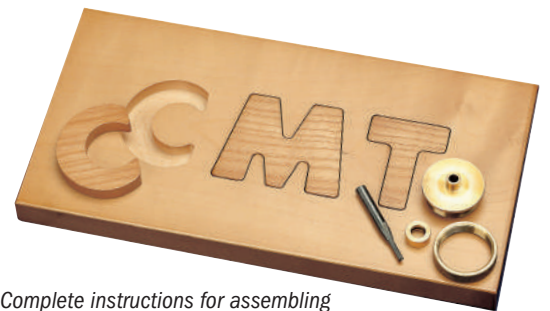

Complete instructions for assembling and using CMT inlay kit are included.

Template Guide Kit

A practical 7 piece bushing kit that will extend the possibilities of your router. For template-controlled operations such as dovetailing, stair routing, hinge butt routing, lock face routing and more general template tasks.

These kits can be used with any router featuring a 30mm (1-3/16") bore baseplate. Fits the most popular routers. Some routers may require CMT's base **899.000.02**.

DESCRIPTION	ORDER NO.
Template Guide Kit	CMT-TGA



CMT-TGA

Optional

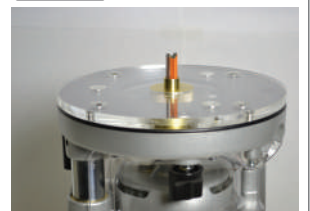

DESCRIPTION	ORDER NO.
Prebored base for CMT7E and CMT8E	899.000.02
Universal base	899.000.01

Set contains:

QTY.	1	1	1	1	1	1	1	2	1
Internal diameter	15,87mm	16,66mm	13,49mm	10,31mm	8,73mm	7,14mm	6,35mm	Lock Nut	Adaptor
Outside diameter	20,24mm	19,05mm	15,87mm	12,7mm	11,11mm	9,52mm	7,93mm	Lock Nut	
Height	14,28mm	14,28mm	14,28mm	7,93mm	3,96mm	7,93mm	3,96mm		

CMT650

The Jig for Perfect joinery!

For use on worktops ranging from 420mm to 650mm in width.

Designed to cut kitchen worktop joints with any type of router.

Letter code system for different operations speeds up and simplifies jig work.

Dimensions: 880x300x 10mm.



JOINTS MADE IN 15 MINUTES! INCLUDING SETUP TIME

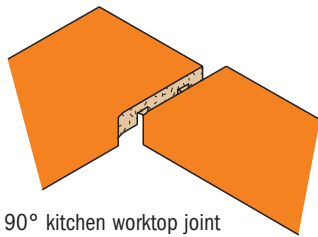

90° kitchen worktop joint

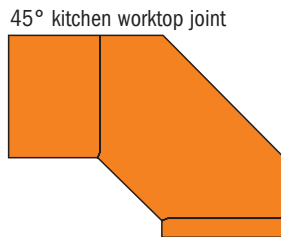

45° kitchen worktop joint

JIG INCLUDES:

- 1 Phenolic template
- 3 Zinc-coated steel guide bushes
- 1 Adjustable end stop
- 1 Instruction manual

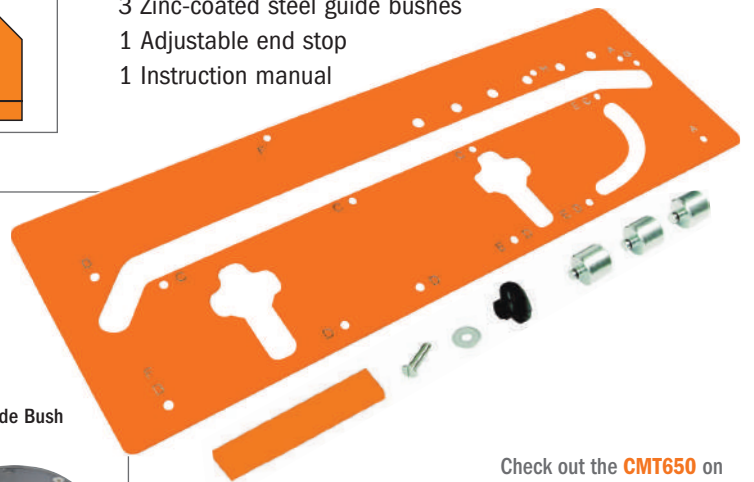

Optional

- Portable router
- Guide bush Ø30mm*
- HW straight bit Ø12mm
- Two clamps

* COMBINATION ROUTERS/ACCESSORIES

Router	Guide bush	Base Plate
CMT7E	899.007.00	CMT300-SB
CMT8E	899.007.00	CMT300-SB
NO-CMT	899.007.00	CMT300-SB1

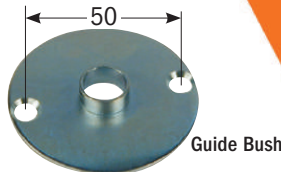

Guide Bush

Prebored Plastic Base Plate



652



8/912

Bits for the jig:

We recommend the use of these Ø12mm straight bits:

ORDER NO.	DESCRIPTION
912.120.11	Ø12x31,7 S=8mm
652.120.11	Ø12x28,3 S=8mm
912.621.11	Ø12x38,1 S=12mm
912.622.11	Ø12x50,8 S=12mm
812.620.11	Ø12x31,7 S=12,7mm
812.621.11	Ø12x38,1 S=12,7mm
652.121.11	Ø12x48,3 S=12mm
652.621.11	Ø12x48,3 S=12,7mm

Check out the CMT650 on



DESCRIPTION	ORDER NO.
Kitchen Worktop Jig	CMT650

CMT650 is designed for Ø12mm straight bits.

- Template made of stable and hardened material.
- For 90° and 45° joints
- Integrated templates for rounding over and chamfering edges.
- Extra guide bush for worktop width of 600mm.
- Two integrated templates for panel bolt recesses.
- Delivered with a clear and comprehensive instruction manual.

Universal Boring Template

CMT's Universal Boring Template has been designed for carrying out precise and productive manual dowelling of furniture elements by using 32mm Euro-System screws. For boring shelf supports with 3mm or 5mm diameter and for making and marking hinge holes. This **CMT900** template will help you prebore the most popular hinge types.

Check out the **CMT900** on



For dowelling into surfaces and shelf supports and hinges

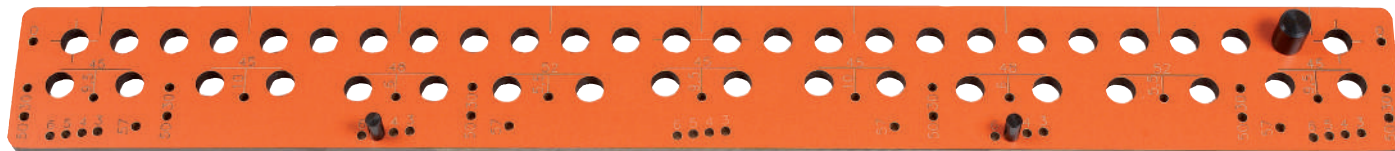

- Laminated phenolic material
- Clear and comprehensible template marking
- Precise end stops

BORING ADAPTORS (not included):

- Suitable for any type of drilling machine
- End stop for different boring depths
- DURALUMIN® body with pre-bored holes for better chip ejection
- Precise, flat seating for proper alignment

ORDER NO. **CMT400-1**

Boring adaptor for **CMT656, CMT900 JIGS**

For bits with up to 30mm drilling depth:

306.030.21 - 306.050.11 - 306.080.11

QUICK AND EASY:

TECHNICAL DETAILS:.....**CMT900**

Max. board width with clamping:900mm

Max board width:no limits

Board thickness:no limits

For dowels:Ø8mm

Hole distance:.....32mm

Number of holes:26

For shelf support:.....Ø3mm, Ø5mm

For hinges:.....Ø3mm for wooden screws
Ø5mm for Euro screws

HW DOWEL BITS (not included):

DESCRIPTION	ORDER NO.
D=3x18mm S=8x20mm HWM	306.030.21
D=5x30mm S=8x20mm HW	306.050.11
D=8x30mm S=8x20mm HW	306.080.11

Other sizes available in **306-307 series**

Boring into a surface for dowel joints using the template.

Boring Ø3mm and Ø5mm holes for shelf supports.

Preboring holes for hinges (base and panel).



CMT900 Boring Template Includes:

- Boring template from laminated pertinax
- End stop set
- End stop set for large elements
- Centering pin for hinges

DESCRIPTION	ORDER NO.
Universal Boring Template	CMT900

Universal Boring Jig

Designed for manual dowelling of furniture elements, this jig with its 32mm perforations, guarantees high precision work and increases productivity. For use with special adaptors **CMT400-1** and **CMT400-2**.

CMT656

For edge dowelling and jointing

- Precise holes
- Detachable end stops
- Ergonomic manual tighteners
- Precise and flat DURALUMIN® profile

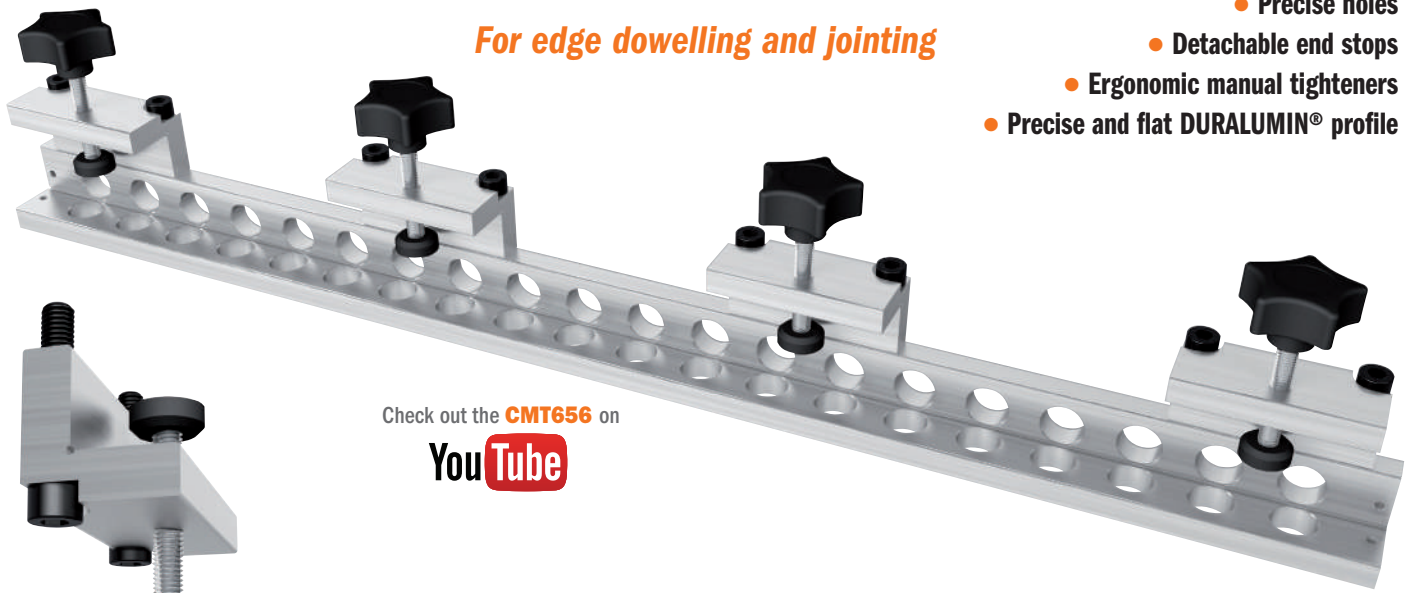

Check out the **CMT656** on



SPARE CLAMP (optional)

To speed up your work with elements of different width.
Order no. **CMT400-3**

UNIQUE SOLUTION

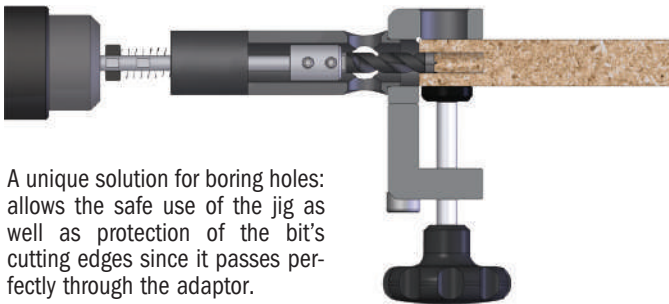

A unique solution for boring holes: allows the safe use of the jig as well as protection of the bit's cutting edges since it passes perfectly through the adaptor.

BORING ADAPTORS (not included):

- End stop for different boring depths
- Suitable for any type of drilling machine
- DURALUMIN® body with holes for better chip ejection
- Precise and flat seating for proper alignment.

ORDER NO. **CMT400-1**

Boring adaptor for **CMT656, CMT900 JIGS** to use with drills bit:

306.030.21 - 306.050.11 - 306.080.11 - 307.050.11

ORDER NO. **CMT400-2** (for screw joints)

Boring adaptor for **CMT656, CMT900 JIGS** to use with drill bit **307.050.11**



HW DOWEL BITS (not included):

DESCRIPTION	ORDER NO.
D=3x18mm S=8x20mm HWM	306.030.21
D=5x30mm S=8x20mm HW	306.050.11
D=8x30mm S=8x20mm HW	306.080.11
D=5x40mm S=8x20mm HW	307.050.11 for screw joints
D=7x40mm S=8x20mm HW	307.070.11 for screw joints

Other sizes available in **306-307** series



3 EASY STEPS IN CREATING DOWEL JOINTS



Place the jig onto the board, fix the end stop and tighten the workpiece. Set the bore depth and clamp the boring adaptor on your drilling machine. Bore vertical holes.



Fasten the jig on the other element, fix the end stop and set the bore depth. Bore horizontal holes.



Now insert the dowels with glue into the holes and join both elements.



As an alternative, use through hole bits and screw the elements together.

TECHNICAL DETAILS: **CMT656**

Max board width (once clamped down)	656mm
For dowels:	Ø8mm
For through holes:	Ø7mm
Hole distance:	32mm
Number of Ø18mm holes:	2x20
Board thickness max:	40mm
Overlap (post-assembly):	0,8mm

DESCRIPTION	ORDER NO.
Universal Boring Jig (656mm in one tightening)	CMT656

Universal Hinges Boring System

The innovative **CMT333** Hinge Boring System with 3 spindle-heads allows you to bore holes for any hinge brand. The universal modular base supports the installation of many boring heads engineered by worldwide leading companies in the sector. Use the **CMT333** universal hinge boring system on all hand-held or standing drill press tools.

CMT333



Check out the **CMT333** on **YouTube**



COMPATIBLE WITH MANY HINGE TYPES

Ø8mm HEXAGONAL SHANK SUITABLE FOR ANY DRILLING MACHINE

GROUND CHROMIUM PLATED SLIDE BARS
(Maximum Length 90mm).

DEPTH LOCK

GREASING POINT

DOUBLE SCREWS FOR SECURE FASTENING

Spare parts



990.009.00

991.067.00

BORING HEAD NOT INCLUDED
Choose from one of these options:

- **CMT333-4211**
- **CMT333-4809**
- **CMT333-4300**
- **CMT333-5255**
- **CMT333-4595**
- **CMT333-325**

SLIDE BAR FOR PANEL SETTING

PLYWOOD BASE

Ø10mm BORES FOR PANEL SETTING BARS



For use on standing drill presses and the CMT Industrio Routing Table.



TECHNICAL FEATURES:

- All parts rust-proof
- Ground aluminum
- Max 5000 RPM
- Six radial antifriction bearings

SAFETY TIPS:

We recommend **Mobil SHC100** for lubrication

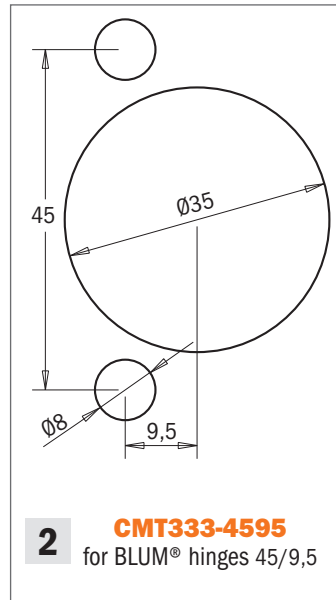
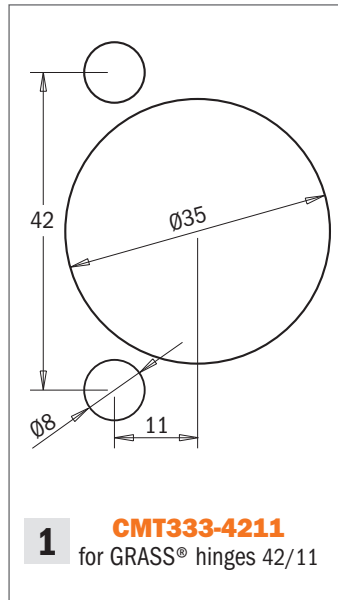

CMT333



Example BLUM® hinge

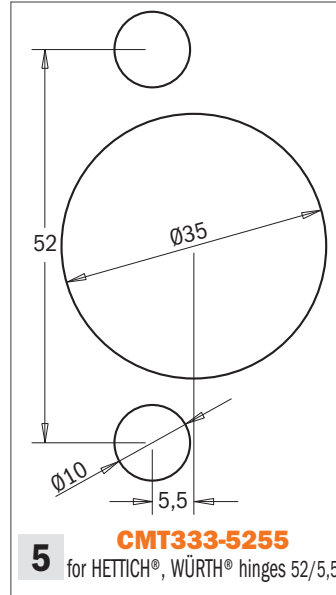
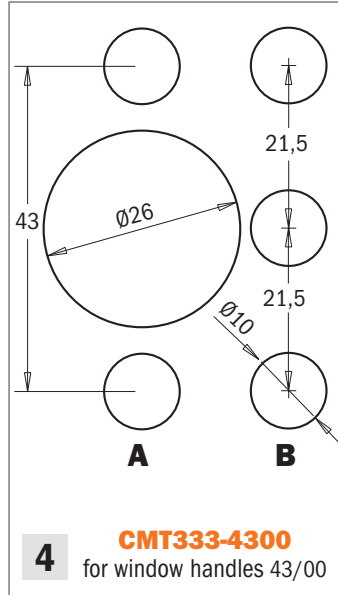
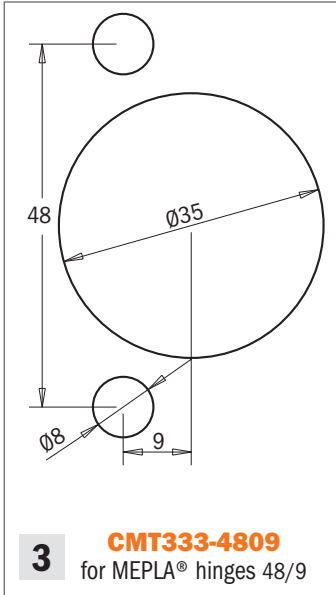

MAXIMUM VERSATILITY

SUPPORT MODULAR BASE	BORING HEADS	DRILL BITS	BORING BIT
ORDER NO.	ORDER NO.	S	ORDER NO.
CMT333	CMT333-4211	8mm	310.080.12 (2 pcs.)
CMT333	CMT333-4595	Hexagonal	310.080.12 (2 pcs.)
CMT333	CMT333-4809	8mm	310.080.12 (2 pcs.)
CMT333	CMT333-4300	Hexagonal	310.100.12 (2 pcs.)
CMT333	CMT333-5255	Hexagonal	310.100.12 (2 pcs.)
CMT333	CMT333-325	Hexagonal	(3 pcs. RH + 2 pcs. LH)
			ORDER NO.
			Left-hand rotation
			Right-hand rotation
			317.350.11
			317.350.11
			317.350.11
			317.260.11/310.100.11
			317.350.11

MAKE YOUR SET

Choose your hinge

1	GRASS®	42/11
2	BLUM®	45/9,5
3	MEPLA®	48/9
4	Window handles	43/00
5	HETTICH®, WÜRTH®	52/5,5
6	SYSTEM 32	32

Boring Head System 32

The universal modular base **CMT333** supports the installation of the System 32 with 5 adaptors.

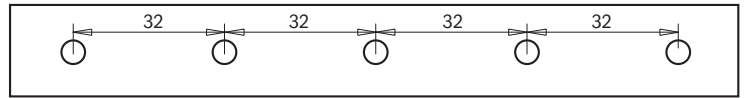

DESCRIPTION	ORDER NO.
Boring head with 5 adaptors for System 32	CMT333-325

BLUM® Hinge Boring Head

The innovative **CMT334** BLUM® Hinge Boring Head features three spindles which allow you to bore hinge holes cleanly and efficiently. For use on boring and point-to-point machines.

DESCRIPTION	ORDER NO.
Hinge Boring Head (bits not included)	CMT334-4595
Boring Bit $\varnothing 35\text{mm} \times 38,5\text{mm}$. Right-hand rotation	393.350.11
Dowel Drill $\varnothing 8\text{mm} \times 38,5\text{mm}$. Left-hand rotation	393.080.12

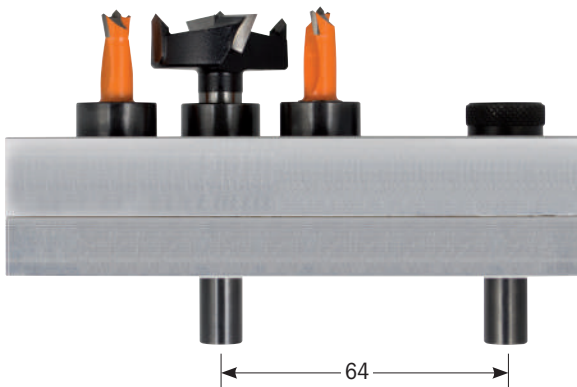

For use on boring and point-to-point machines

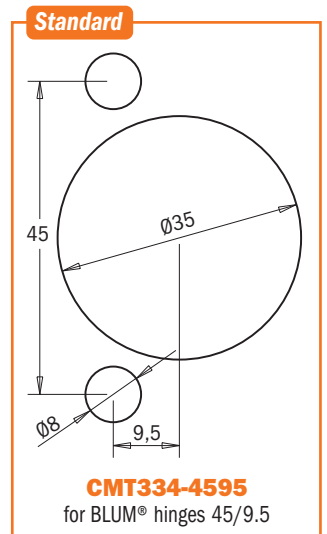

Adjustable Torque Screwdriver Set 1~6 Nm



The Adjustable Torque Screwdriver set includes 20 types of inserts and provides a sturdy protective case to store and keep tools safe. In addition to the instruction manual, inside you'll find the calibration certificate (unique for each instrument) according to DIN ISO 6789 & ASME B107.300-2010.

TW-006

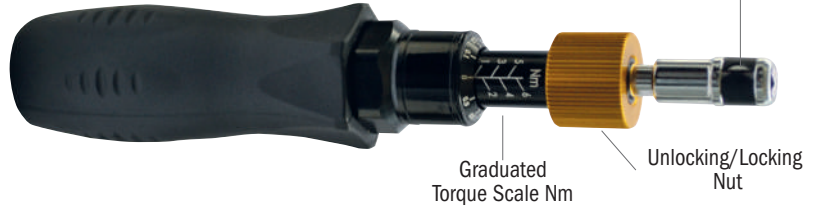

Standard Equipment

- Torque screwdriver
 - 20 types of inserts:
 - Plastic case
 - Instruction manual
 - Calibration certificate
- ⊕ 0-1-2-3 (n°4 pcs)
 - ⊖ 8-9-15-20-25 (n°5 pcs)
 - ☆ 3-4-5-6 (n°4 pcs)
 - ⊕ 1,5-2-3-4-5-6 (n°6 pcs)
 - + Square Adaptor 1/4" (6,35mm), n°1 pc

TECHNICAL DETAILS:

- Range..... 1~6 Nm
- Resolution..... 0.1 Nm
- Tolerance..... ±6%
- Length..... 195mm (7.7")
- Weight..... 335gr. (11.8oz)
- Automatic quick-release, audible and palpable click, when selected torque is reached
- Automatic reset after 90°
- Right-handed (CW)

TORQUE SUGGESTED*

THREAD	Nm
M2,5	1,0
M3	1,2
1/8"	1,4
M3,5	1,8
M4	2,7
M5	5,3

* Suggested tightening torque for CMT screws (Class 8.8)

APPLICATION:

The Adjustable Torque Screwdriver is versatile enough for use in many fields, but we recommend it for the tightening or fastening of CMT bits and cutter heads with interchangeable knives. Some CMT products may require the use of an extension, which is not included in the TW-006 set.

To download this user manual in a different language, visit www.cmtorangetools.com

DESCRIPTION	BOXES	ORDER NO.
Adjustable torque screwdriver set 1~6 Nm	24	TW-006

Interchangeable Torque Wrench 20~200 Nm

The Interchangeable Torque Wrench comes complete with a sturdy protective case to store and keep tools safe, an instruction manual, and calibration certification (unique for each instrument) according to DIN ISO 6789 & ASME B107.300-2010.

TW-200



Optional



TECHNICAL DETAILS:

- Range..... 20~200 Nm (10-150 lbf-ft)
- Resolution..... 1 Nm
- Tolerance..... ±4%
- Length..... 500mm (19.7")
- Weight..... 1,15Kg. (40.6oz)
- Automatic quick-release, audible and palpable click, when selected torque is reached
- Right-handed (CW)

TORQUE SUGGESTED*

CHUCK / COLLET	Nm	Lbf-ft
ER16	57	42
ER20	80	59
ER25	104	77
ER32	135	100
ER40	176	130
EOC25	122	90

* Suggested tightening torque for CMT Chuck/Collet

To download this user manual in a different language, visit www.cmtorangetools.com

APPLICATION:



The Interchangeable Torque Wrench is versatile enough for use in many fields, but we recommend it for the tightening of CMT chucks.

DESCRIPTION	S mm	BOXES	ORDER NO.
Interchangeable Torque Wrench 20~200 Nm	14x18	12	TW-200
Hook Head Insert Ø=28-36mm (ER16 & ER20)	14x18	1	TW-2836
Hook Head Insert Ø=40-45mm (ER25)	14x18	1	TW-4045
Hook Head Insert Ø=50-55mm (ER32)	14x18	1	TW-5055
Hook Head Insert Ø=58-62mm (ER40 & EOC25)	14x18	1	TW-5862
Hook Head Insert Ø=80mm (Kinetic Dust Extractor 992)	14x18	1	TW-8001
Hook Head Insert Ø=100mm (Kinetic Dust Extractor 992)	14x18	1	TW-1001
Push Ratchet Insert S ₂ =3/8"	14x18	5	TW-A095
Push Ratchet Insert S ₂ =1/2"	14x18	5	TW-A127
Adaptor Insert S ₂ =9x12mm	14x18	50	TW-A912

3D Router Carver System



Exclusively from your CMT distributor

RCS

Turn your router into a remarkable carving tool. It's fast, easy, and a whole lot of fun!

Who says that intricate woodcarving requires an artist's touch? Thanks to the patented 3D Router Carver system, anyone with a plunge router can create any of the beautiful designs shown on these pages in just minutes. Decorate doors, drawers, cabinets, furniture or just about any flat wooden surface with one or more of these designs. How does it work? The secret is in the 3D Router Carver Bit and the way that bit interacts with the carving templates. The V-Groove router bit is enclosed in a 45° cone-shaped guide. You rout with the plunge mechanism of your router unlocked, allowing the bit to move up or down as the router moves forward. As the slot in the template get wider, the bit moves down, producing a wider, deeper V-groove. As the slot gets narrower, the bit moves up, and the groove gets narrower and shallower. It sounds simple, and it is! (that's why the system is patented worldwide). Please see the illustrations below for more details on the carving technique. You'll receive complete instructions with your 3D Carver templates. For an informative visual demonstration, check out the 3D Router Carver video on our web site.

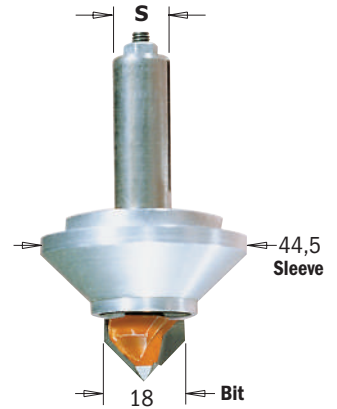

What do you need to get started?

- The 3D Router Carver bit
- The Carver template of your choice
- The Holding frame to match your template
- Your plunge router

Check out
3D Router Carver System on



(Note: Be sure the opening at the base of your router is at least 47,6mm in diameter. If it isn't, you'll need to make a sub-base to accept the large diameter of the 3D Carver bit.)

3D Router Carver Bit & Sleeve

S mm	ORDER NO. Right-hand rotation	Spare parts						Optional
8	RCS-BIT8	RCS-CUT8	RCS-SLE8	RCS-SHIELD		RCS-NUT8	991.007.00	RCS-SLEEVE8
12,7	RCS-BIT	RCS-CUT		RCS-SHIELD	990.091.00		990.092.00	

Here's how it works:

1. Clamp or tack the holding frame to your workpiece

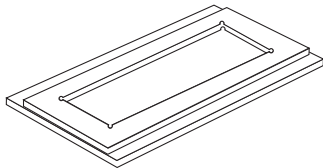

2. Drop the template into the center of the frame

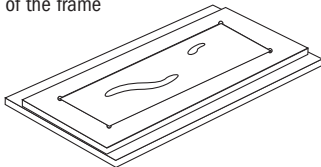

3. Plunge the bit into a wide part of the slot and rout with the router's plunge mechanism unlocked.

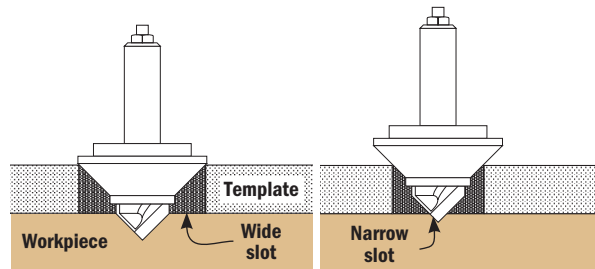

Allow the plunge mechanism to move up and down as you advance.
Wider template slots allow wider, deeper grooves.
Narrower slots produce shallower grooves.

4. With the frame still in place, flip the template & rout again. Some templates will be routed 2 to 4 times, depending on the complexity of the design.

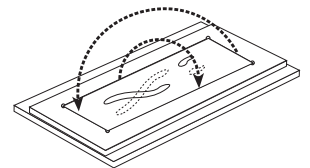

5. Remove the frame and you're finished!

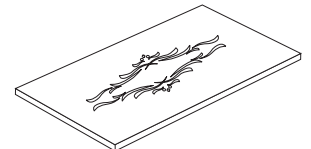

CABINET DOOR & PANEL CARVINGS

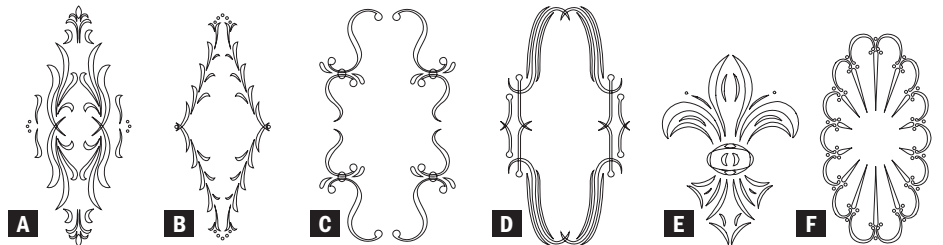

These designs are ideal for the doors or panels of cabinets, entertainment centers, fireplace surrounds or almost any flat surface. See the designs below for complementary patterns for drawers, rails and corners. Approximate carving time is 5 minutes.

DESCRIPTION	CARVING DIMENSIONS mm	NO. OF TEMPLATES	ORDER NO.
Classical cabinet door - A	440 x 185	2	RCS-302
Florentine cabinet door - B	415 x 170	2	RCS-304
Cascade cabinet door - C	365 x 210	1	RCS-305
Roma cabinet door - D	375 x 200	1	RCS-306
Fleur-de-Lys door - E	250 x 180	4	RCS-805
Spanish fan template - F	380 x 200	2	RCS-806
Cabinet door holding frame			RCS-003





TIP: Many carvings, like the Florentine rail, are enhanced with the addition of a rosette.



PANEL & RAIL CARVINGS



With a long, horizontal shape, these designs are perfect for door rails, headboards, cabinet face frames and valences. Approximate carving time is 4 minutes.

DESCRIPTION	CARVING DIMENSIONS mm	NO. OF TEMPLATES	ORDER NO.
Classical Rail - A	550 x 120	2	RCS-402
Florentine Rail - B	550 x 130	2	RCS-404
Cascade Rail - C	530 x 110	3	RCS-405
Folklore Rail - D	550 x 110	3	RCS-406
Rail Holding Frame			RCS-004

DRAWER & FURNITURE CARVINGS

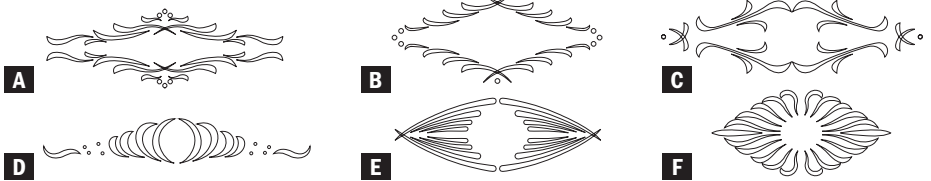

Originally intended for drawer fronts, these designs are great for lots of other projects: small doors, side panels of cabinets, furniture and more. For door and drawer combinations, match the style of the door designs above. Approximate carving time is 4 minutes.

DESCRIPTION	CARVING DIMENSIONS mm	NO. OF TEMPLATES	ORDER NO.
Classical Drawer - A	210 x 70	2	RCS-502
Florentine Drawer - B	195 x 85	2	RCS-504
Cascade Drawer - C	250 x 65	1	RCS-505
Folklore Drawer - D	250 x 40	2	RCS-506
Roma Drawer - E	190 x 65	2	RCS-507
Blaze Drawer - F	250 x 110	2	RCS-510
Drawer Holding Frame			RCS-005

CORNER & SMALL DECORATION CARVING DESIGNS

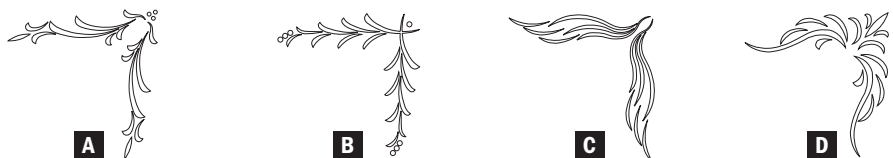

DESCRIPTION	CARVING DIMENSIONS mm	NO. OF TEMPLATES	ORDER NO.
Classical - A	155 x 40	3	RCS-602
Florentine - B	120 x 30	3	RCS-604
Cascade - C	190 x 40	3	RCS-605
Folklore - D	150 x 45	3	RCS-606
Corner Holding Frame			RCS-006

ROSETTE CARVINGS

You get two templates for the price of one with these designs! Each item includes templates for two sizes of rosette. Use with the rosette frame sold above, or use the large rosettes with the cabinet door frame or small rosettes with rail frame.

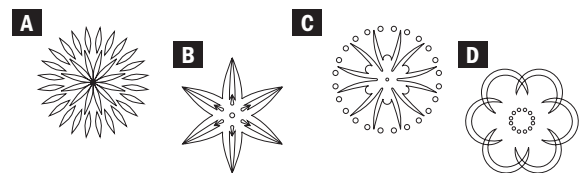

DESCRIPTION	CARVING DIMENSIONS mm	NO. OF TEMPLATES	ORDER NO.
Rosette #1 & #5 - A	85 x 68	2 & 2	RCS-701
Rosette #2 & #6 - B	88 x 70	1 & 1	RCS-702
Rosette #3 & #7 - C	82 x 65	1 & 1	RCS-703
Rosette #4 & #8 - D	79 x 62	1 & 1	RCS-704
Rosette Holding Frame			RCS-007

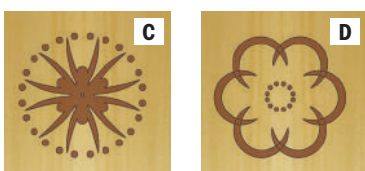
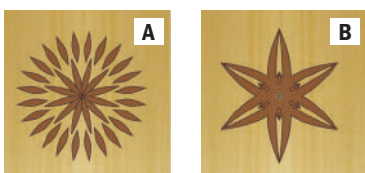

SOUTHWESTERN CARVING DESIGNS

RCS

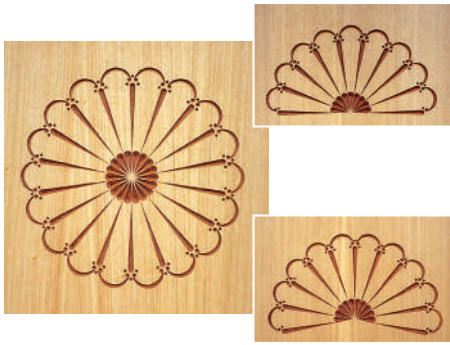

These popular Southwestern designs are actually several shapes in one. Both sizes can be routed as circular carvings, or use only portions of the template to suit your project.

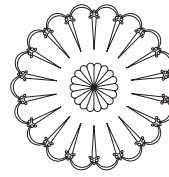

Rout the complete spanish fan design or make partial rosettes

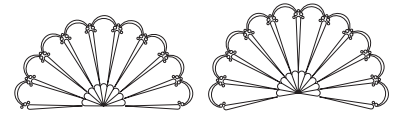

DESCRIPTION	CARVING DIMENSIONS mm	NO. OF TEMPLATES	ORDER NO.
Large Spanish Fan	400	1	RCS-801
Small Spanish Fan	200	1	RCS-802
Rosette Holding Frame			RCS-007

Special designs for animal lovers!



Your imagination will be your guide on these neat designs. Furniture or decorations for the kids, paneling for the den or rec room, a gift for the sportsman.

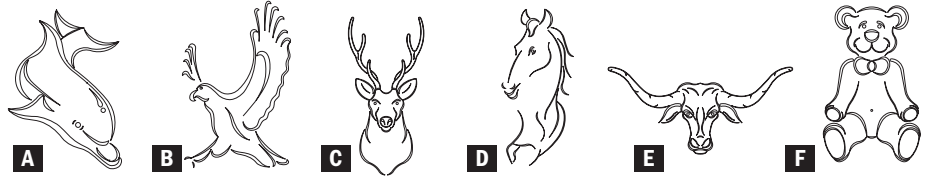

DESCRIPTION	CARVING DIMENSIONS mm	NO. OF TEMPLATES	ORDER NO.
Dolphin - A	200 x 290	4	RCS-803
Eagle - B	178 x 298	4	RCS-804
Deer - C	394 x 190	4	RCS-901
Horse - D	445 x 203	3	RCS-902
Longhorn - E	419 x 194	4	RCS-904
Teddy bear - F	394 x 203	3	RCS-906
Cabinet Door Holding Frame			RCS-003

Bowl & Tray System

BTS-002

CMT System **BTS-002** provides a fun and easy way for you to make divided bowls and trays in your shop. No lathe? No problem. This bowl making technique uses a router and CMT's unique bowl and tray router bit. The resulting bowls and trays are beautiful. This kit also provides an excellent way to use up scrap wood. Glue pieces together, butcher block style, to make a beautiful pattern of colors and species.

The templates will withstand a lifetime of use and can be used to make a variety of bowl or tray styles. The collet extension, used to make extra deep bowls, is also useful whenever your general woodworking requires extra deep cuts.



TMP-011
MDF Template



TMP-012
MDF Template



Trace the templates onto the bowl blank.



Rough out the interior using a drill press and a 50,8mm Forstner bit.



Rout the interior to final shape using the bowl and tray router bit and collet extension.



Bandsaw the exterior to final shape.



Watch the video on
YouTube

DESCRIPTION	ORDER NO.
Bowl & Tray System	BTS-002 ■
<i>The kit includes</i>	
Router Bit S=12mm	951.502.11B
Router Collet Extension	796.002.00
MDF Template nr. 1	TMP-011
MDF Template nr. 2	TMP-012
Instruction manual	

■ Until stock last

Digital Height Gauge

DHG-001



- Precise measurements for router bits, saw blades, band saw blades, cutter heads, drill bits, holes depth.
- Measuring ruler with Metric/Imperial scale and locking screw.
- Horizontal & vertical measuring.
- Digital easy-to-read display.
- Self-standing with magnets, for setting cutting depth on router tables and low profiles for backfence adjustment.
- Instruction manual.



TECHNICAL DETAILS:

- Measuring range:Scale: 0~80mm (0~3-1/8");
- Needle:0~50mm (0~2")
- Wide opening:60mm (2-23/64")
- Resolution:0.05mm (0.002")
- Accuracy:±0.1mm (±0.004")
- Battery:**Included**
- Battery Type:CR2032-3V; Lithium Button Cell

DESCRIPTION	BOXES	ORDER NO.
Digital Height Gauge	8	DHG-001

Place your gauge on a flat surface and set to "0" on the display.

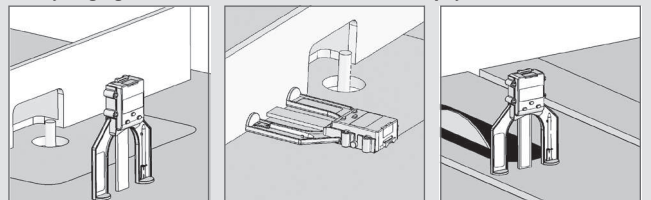

Position your gauge on the desired position.

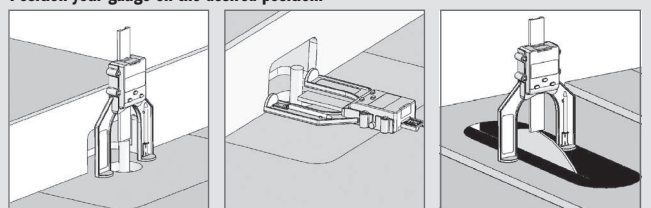

Insert needle and set to "0".

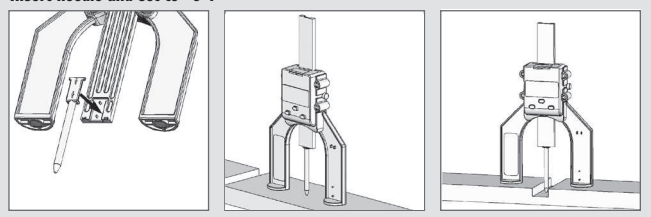

Digital Moisture Meter

DMM-001



Ideal for use in woodworking, building construction and agriculture industries. The **DMM-001** is also an invaluable tool in the restoration field. Ideal for locating moisture in carpets and sub-flooring. Ultra-sensitive Digital Moisture Meter easily detects hidden leaks in wood, concrete, plaster and carpet. Providing accurate moisture level readings make this tool great for new home inspections, locating roof leaks or even selecting dry lumber at the yard. Display will show the moisture content in Percent Moisture Content directly.



Calibration holes

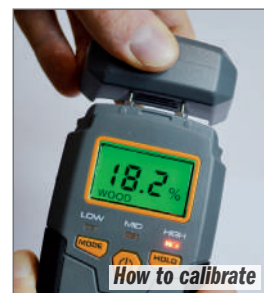

How to calibrate

TECHNICAL DETAILS:

- Measures moisture content by detecting a material's electrical resistivity using two pins.
- Measurement output is displayed on a practical LCD screen.
- Instruction manual.
- Moisture measuring range: 5~50% (in wood); 1.5~33% (in building material)
- Measuring accuracy: ±2%
- Backlight shut off: Approx. 15 seconds
- Auto power off: After 3 minutes idle
- Battery:**Included**
- Battery Type:9V Battery Block (6F22 or 6LR6); Alkaline
- Low battery indicator: <7V
- Working current: <25mA
- Working temperature: 32°F~122°F
- Working humidity: <90%RH non-condensing
- Storage: -4°F~140°F ≤85% (without battery)
- Dimensions: 145 x 65 x 25mm (5-11/16" x 2-9/16" x 1")
- Weight: About 3oz (without battery)



DESCRIPTION	BOXES	ORDER NO.
Digital Moisture Meter	5	DMM-001

Spare parts DMM-001/1 Set 2 Pin for DMM-001

Digital Angle Gauge

DAG-001



The digital angle gauge is a mini waterproof digital protractor that provides digital readings between $\pm 90^\circ \times 4$ with a resolution of 0.1° and features auto shut off after 5 minutes. It is small enough to be carried around in your pocket and the LED screen is easy to read. It incorporates magnets in the base for adhesion to any ferrous surface to accurately measure mitre and bevel angles on mitre saws, saw benches, etc.

- Accurately sets saw blade bevel angle, works great for miter saws and table saws.
- Automatic LCD backlight
- Large display for easy digital reading
- Measurements in absolute or relative mode
- Angles displayed in degrees
- Automatic digit inversion for overhead measurements
- Set to ZERO
- Magnetic base
- Case included
- Instruction manual

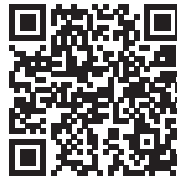

Watch the video on **YouTube**

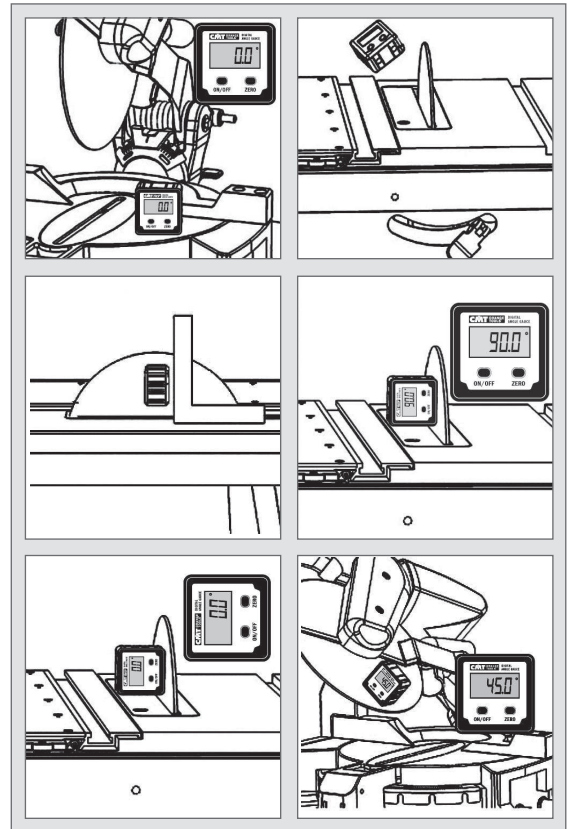

TECHNICAL DETAILS:

- Range: $\pm 90^\circ \times 4$
- Resolution: 0.1°
- Battery: **Included**
- Battery Type: AAA-1.5V; Alkaline
- Dimensions: $60 \times 60 \times 28\text{mm}$
($2\text{-}3/8" \times 2\text{-}3/8" \times 1\text{-}1/8"$)

DESCRIPTION	ORDER NO.
Digital Angle Gauge	DAG-001

Digital Angle Finder

DAF-001



This digital angle finder is a multi-functional tool for many measuring applications. Easy to operate, the base unit carries the electronics featuring clear detailed LCD display, a pair of levelling vials and a pivoting measuring arm. When the arm is extended, the angle created with the base is indicated clearly on digital read-out to the nearest 0.05° . The measuring range is $0 - 360^\circ$. The vials allow both vertical and horizontal variations to be accurately measured. Other features include a lock function to prevent the last measurement being lost, a low battery indicator and automatic shut off function. Robust yet lightweight, this tool is very versatile.

DESCRIPTION	ORDER NO.
Digital Angle Finder	DAF-001



Watch the video on **YouTube**



- Easy and simple to use.
- Calculates angles in seconds.
- Large detailed LCD display.
- Robust, lightweight aluminium construction.
- Instruction manual.

TECHNICAL DETAILS:

- Range: $0 - 360^\circ$
- Resolution: 0.05°
- Battery: **Included**
- Battery Type: ... CR2032-3V; Lithium Button Cell
- Dimensions: $260 \times 50 \times 25\text{mm}$ ($10\text{-}1/4" \times 2" \times 1"$)

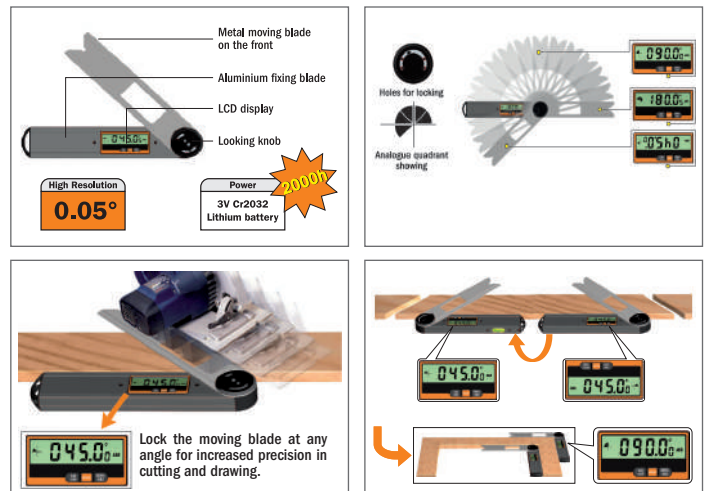

Laminate/Veneered-Panel Cutter

A very useful hand tool for clean, splinter-free cuts on laminates and veneer with no waste. Place your material into the fence provided and run the cutter along the edge of the panel. The two opposing steel-made circular cutting blades mounted on roller bearings will trace the cutting line. Use the micrometer knob on the top of the tool to set the cutting thickness, or adjust the strip width by using the metric/inch scale provided. Loosen the lock knob on the scale, move the metal bracket which holds the fence and tighten the lock knob again on the desired cutting width.

DET-003



TECHNICAL DETAILS:

- Cutting width: 12~110mm (15/32" ~ 4-21/64").
- Cutting depth: 0~2mm (0 ~ 5/64").
- Weight: 1.2 kg (2.65 lbs).

DESCRIPTION	ORDER NO.
Laminate/Veneered-Panel Cutter	DET-003

Spare parts DET-003K Pair of cutters right-left for DET-003

Edge Banding Iron

Apply pre-glued edge banding easily and accurately. The iron non-stick surface allows smooth and easy application. The thermostatically controlled short preheat time gets you working quicker. Includes heat resistant metal base to place iron when not in use.

DET-004

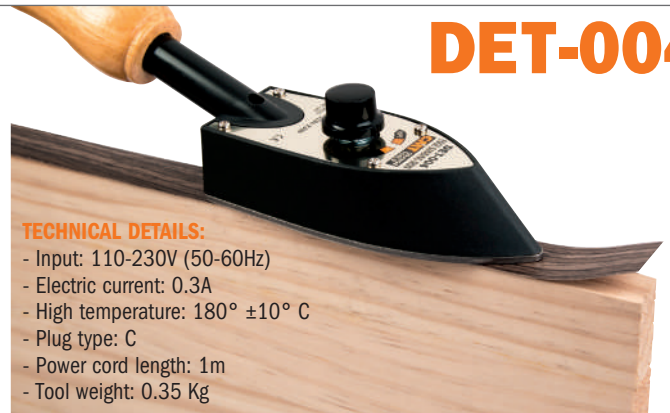

FEATURES:

- Thermostatic heat control.
- Non-stick coating.
- Specially shaped shoe with rounded edges.
- Metal stand.

TECHNICAL DETAILS:

- Input: 110-230V (50-60Hz)
- Electric current: 0.3A
- High temperature: 180° ±10° C
- Plug type: C
- Power cord length: 1m
- Tool weight: 0.35 Kg

DESCRIPTION	ORDER NO.
Edge Banding Iron	DET-004

Edge Banding End Trimmer

An indispensable tool for easy and safe end trimming after edge banding. Position the tool on the banding, press down on the handle to operate the blade in a shearing action. The cutting knives are interchangeable, so when the cutting knife becomes dull, you can simply replace it with the anvil knife for a double lifetime. For cutting banding up to 0,5mm thick with a maximum cutting width of 54mm. This tool can also be paired up with our double edge trimmer **DET-001**. We recommend using our edge banding end trimmer **DET-002** before using our double-edge trimmer **DET-001**.

DET-002



DESCRIPTION	ORDER NO.
Edge Banding End Trimmer	DET-002

Spare parts DET-002K 2-Pcs replacement blade set 55x13x1,5mm

Double-Edge Trimmer

Attach this trimmer to your workpiece, press both ends against the board for a cutting range between 13mm (1/2") and 25mm (1"), move the trimmer in the correct direction indicated by the arrow. This will cut on both sides easily. The first cutter will cut straight, the second one can be adjusted for a tapering cut. Both cutters are made from high-quality hardened steel and can be easily replaced when worn out.

DET-001



DESCRIPTION	ORDER NO.
Double-Edge Trimmer	DET-001

Spare parts DET-001K Spare knives for double-edge trimmer

Diamond Whetstones

For professional, industrial and home users

DSS

FAST: real quality diamond, the hardest known material, reduces the sharpening process.

EASY: stoke the blade across the surface with little pressure.

DURABLE: we use natural diamonds for long-lasting performance.

VERSATILE: for sharpening any hard material, steel, glass, ceramic, tungsten carbide, etc.



FOR SHARPENING, HONING AND LAPPING

- axes
- bayonets
- broadheads
- cable cutters
- carbide cutters
- chainsaws
- chisels
- climbing equipment
- engraving tools
- farm and garden tools
- fish hooks
- Forstner bits
- knives
- lapidary tools
- lawn mower blades
- masonry drills
- moulds and dies
- plane blades
- planer /jointer knives
- pruners

- ring tool
- router bits
- saw blades
- scissors
- shears
- ski and snowboard edges
- small contact area and pointed tools
- speed and hockey skates
- woodcarving scrapers
- woodturning tools

FOR ABRADING HARD MATERIALS

- ceramic
- composites
- fiberglass
- glass
- stainless steel
- stone
- titanium
- tool steel
- tungsten carbide

FOR FLATTENING

- chisel backs
- engine heads
- machine bolsters and ways

Watch the video on **YouTube**



Universal diamond whetstone in leather sheaths

DIMENSIONS	GRAIN mm	GRAIN	ORDER NO.
115 x 25 x 3	D15 extrafine	green	DSS-115E
115 x 25 x 3	D25 fine	red	DSS-115F
115 x 25 x 3	D46 coarse	blue	DSS-115M
115 x 25 x 3	D76 extracoarse	black	DSS-115G

Diamond whetstone file

DIMENSIONS	GRAIN mm	GRAIN	ORDER NO.
100 Ø4,8	D54 coarse	blu	DSS-048M

Universal diamond whetstones in hardwood case

DIMENSIONS	GRAIN mm	GRAIN	ORDER NO.
150 x 52 x 16	D15 extrafine	green	DSS-150E
150 x 52 x 16	D25 fine	red	DSS-150F
150 x 52 x 16	D46 coarse	blue	DSS-150M
150 x 52 x 16	D76 extracoarse	black	DSS-150G

A unique production process to guarantee long tool life

A perforated steel plate is moulded onto a strong plastic base by applying high pressure. The steel is then covered with natural diamonds embedded into a nickel plate. The pattern and diamond coating ensures fast sharpening, whereas the plastic indents hold the lubricating water and disperse the fine dust emitted by the diamonds during sharpening.

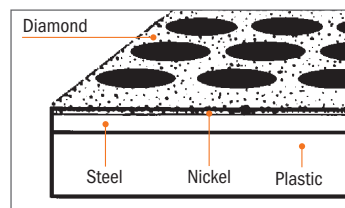

The diamond whetstones are available in four meshes for multiple purposes:

D15 EXTRAFINE/GREEN (9 microns, 1200 mesh)

To refine and polish sharp edges to razor sharp perfection. If you are new to sharpening or need your knife or tool edges as sharp as possible, this grain type is what you are looking for.

D25 FINE/RED (25 microns, 600 mesh)

To restore any slightly dull knife or tool edges to perfect sharpness. Professional chefs and gourmet cooks prefer using this grit grain, too. This product is perfect for the edge refinement process before micro-refinement and polishing.

D46 COARSE/BLUE (45 microns, 325 mesh)

To quickly restore dull and worn edges. Professionals who require faster cutting action and less edge refinement often use this medium grit grain.

D76 EXTRA-COARSE/BLACK (60 microns, 220 mesh)

Recommended for aggressive removal of metal and metallic residue on damaged tools or restore heavy-duty outdoor tools such as axes and lawn mower blades. This grit grain is commonly used as a first step for flattening the back of chisel and plane irons or for rapid stock removal from chipped or badly damaged edges.

INSTRUCTIONS

Use water for lubrication, after use, rinse and store dry.

1. Keep your knife with cutting edge away from you.

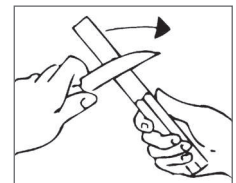

2. Apply some water to the stone surface. Hold blade 20° to diamond surface.

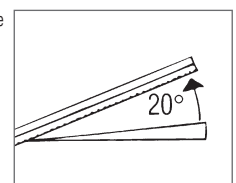

3. With little pressure and in long strokes push the blade across surface. From edge heel to edge tip, alternately on both sides. For pointed tools. Use the unperforated diamond area.

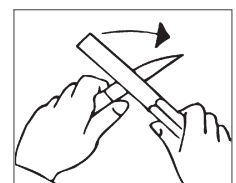

Bench Block Set

BBS-001

These blocks are great for holding your workpiece steady without resorting to the use of clamps. Their anti-slip surface grips adheres to both your bench top and the underside of your workpiece. By raising the workpiece off the main bench top, you automatically create extra clearance underneath so you can put your router bits and cutters conveniently to work!

Length: 75mm
Width: 50mm
Height: 25mm



DESCRIPTION	ORDER NO.
Bench block set (4-Pcs.) 75x50x25	BBS-001

Bit Organizer

100 bits at your fingertips

You always need your most used bits within reach! They also need to be safely organized. CMT offers a perfect solution for keeping them in order with a handy organizer. Conveniently holds up to 100 router or drill bits of any size with the use of a CMT interchangeable bushing to fit all shank diameters. See options listed below.

03.51



DESCRIPTION	ORDER NO.
Bit Organizer 320x320x45mm (without bushings)	03.51.0106
Interchangeable Bushings for Ø6mm shank (20-Pcs.)	03.51.0046A
Interchangeable Bushings for Ø6,35mm shank (20-Pcs.)	03.51.0047A
Interchangeable Bushings for Ø8mm shank (20-Pcs.)	03.51.0048A
Interchangeable Bushings for Ø9,5mm shank (20-Pcs.)	03.51.0057A
Interchangeable Bushings for Ø10mm shank (20-Pcs.)	03.51.0058A
Interchangeable Bushings for Ø12mm shank (20-Pcs.)	03.51.0059A
Interchangeable Bushings for Ø12,7mm shank (20-Pcs.)	03.51.0049A

Formula 2050: Blade & Bit Cleaner

An incredibly effective cleaner for all cutting tools!

998

Saw shops know how to get the most out of cutting tools. They also know that pitch and residue build-up greatly shorten the life of carbide and compromise performance. We asked various blade sharpeners to test our **Formula 2050** and they all rated it as an excellent product. Why is it so effective? Because CMT's **Formula 2050** penetrates the microscopic cracks in the resin and attacks the bond between carbide/steel surface and the resin itself. **Formula 2050** keeps your tools in top-notch condition increasing lifespan between sharpening and replacement.



998.001.01



998.001.03

Prolonged use of this product may cause damage to special coating treatments applied to aluminum tool surfaces. Use with caution.

DESCRIPTION		ORDER NO.
0,5 lt. spray bottle	8	998.001.01
5 lt. plastic jug	2	998.001.03

- Removes pitch, resin and adhesive residue from all woodworking cutting tools (saw blades, router bits, drill bits, shaper cutters, planer blades, etc.)
- Do not rinse after cleaning. Formula 2050 provides protection from rust and corrosion. Keeps your table saw top rust-free, too!
- Can be applied by spray bottle or used in ultrasonic cleaners and dip tanks.

Contact our Sales Department for terms and conditions of delivery and minimum quantity orders.

Formula 998: Lubricant for Wood, Neutralizes Resin

- Neutralizes resin, preventing it from being stuck on chips and sawdust.
- Cleans knobs, barbell handles, etc.
- Anti-corrosion action on woodworking machine table.
- Excellent against humidity.

998

DESCRIPTION		ORDER NO.
1 lt. spray bottle	12	998.002.01
5 lt. plastic jug	2	998.002.03

Contact our Sales Department for terms and conditions of delivery and minimum quantity orders.



Watch the video on **YouTube**



998.002.01



998.002.03



INSTRUCTION: spray or use a brush to apply the product on machine parts. A uniform layer of product on surfaces helps the workpiece slide better, reduces attrition and prevents sticking.

Latex Coated Gloves

These protective gloves are not only comfortable but offer high elasticity, impressive grip as well as good resistance to abrasion, perforation and tears. CE Certified and Mechanical Hazards EN 388:2016 compliant (2132X). Available in three sizes!

GLA



DESCRIPTION		ORDER NO.
Latex coated gloves M (8)		25 GLA-08M
Latex coated gloves L (9)		25 GLA-09L
Latex coated gloves XL (10)		25 GLA-10XL

CMT Professional Tool Bag

- Top zipped design and wide opening for accessing tools easily.
- Sturdy material and hard rubber bottom are resistant to rough handling and protects the contents from hard falls.
- 6 interior pockets, 12 exterior pockets.
- Ideal for storing and transporting hand tools as well as other medium sized items & accessories.

BAG-001

Material: Polyester 600D with 3mm EPE foam
Dimensions: 400x200x250mm

DESCRIPTION		ORDER NO.
CMT Professional Tool Bag	12	BAG-001



5 rubber studs at bottom



Carpenter Pencil & Ink Pen

An easy-grip shape and larger rectangular surface area means this pencil won't roll away or slip from your hands. The non-round core makes highly legible thick or thin lines.

Perfect for high precision tracing and marking virtually any surface. Easy to erase.

Strong break-resistance lead center withstands rough handling as well as the rigours and extreme conditions of the construction environment.

PCL-1



PCL-2

DESCRIPTION		ORDER NO.
Carpenter Pencil	50	PCL-1
CMT Ink Pen	50	PCL-2



Deep Hole Mechanical Marker



- Tip length 45mm (05.7mm) for marking tight and hard to reach places.
- Push-feed button for automatic lead advancement with built-in sharpener.
- CMT refills O2.8mm insertable at tip or opposite end.
- Sturdy metal body and handy pocket clip.
- Marks a variety of surfaces, rough or smooth, dry, wet or dusty.
- CMT refills available in Graphite (2B) or Crayon (red & yellow), each marker includes one graphite lead.
- **Graphite** ideal for marking: Paper, Wood, Laminates, Masonry, Stone and Artificial Stone, Metals and Non-Ferrous Metals.
- **Crayon*** ideal for marking: Plastics, Ceramic, Glass, Paper, Wood, Laminates, Masonry, Stone and Artificial Stone, Metals and Non-Ferrous Metals.

*Colored leads are made of wax, which means they are softer and more fragile than graphite leads. Handle them with care.



PCL-3D

DESCRIPTION	ORDER NO.
Deep Hole Mechanical Marker (display)	PCL-3D
Set contains	
24 pcs. PCL-3 Deep Hole Mechanical Marker	
8 pcs. PCL-3B Graphite Refills Leads (6 pcs.)	
4 pcs. PCL-3C Graphite (2 pcs.) & Crayon Refills Leads (2 pcs. red + 2 pcs. yellow)	



WARNING:
Avoid breakage!
To close after refilling, carefully align the four grooves inside of pen barrel and cap.



Align the 4 grooves

DESCRIPTION	Box Icon	ORDER NO.
Graphite Refills Leads (6 pcs.)		PCL-3B
Graphite (2 pcs.) & Crayon Refills Leads (2 pcs. red + 2 pcs. yellow)		PCL-3C

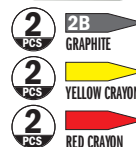

CMT ORANGE TOOLS®

CMT ORANGE TOOLS®

CMT

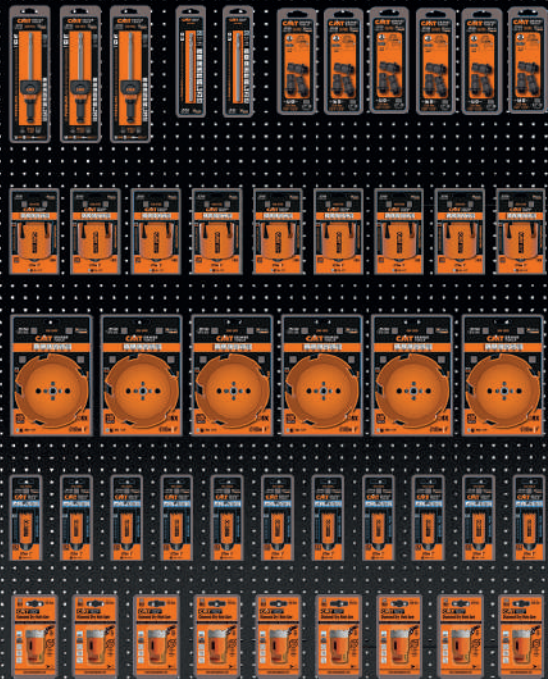

DISPLAY CABINETS



PRODUCTS	PAGE
Display Cabinets for Saw Blades	428
Display Cabinets for Sabre & Jig Saw Blades	429
Display Cabinets for Multi-Cutters	430
Display Cabinets for Router Bits	431
Display Cabinets for Drill & Boring Bits	432
Display Cabinets for Hole Saws	433
Display Cabinets for Router Bits & Forstner Bits	434
Multi Tools Mini Counter Display	435



Display Cabinets for Saw Blades

A sturdy steel saw blade display cabinet equipped with a backlight to place anywhere in your store. Hang and display a variety of different saw blades. Contact your CMT representative to seek advice on the most effective sawblade display composition for your needs. Tools not included. Dimensions in cm.

SUITABLE FOR ALL BLADE TYPES

03.00.0038

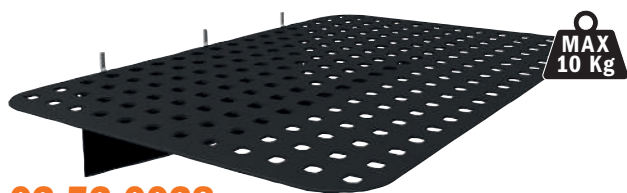

03.53.0038

Minimum order 2-pieces or multiple
For use with display cabinets 03.00.0038 and 03.00.0045

Display image for information purposes only

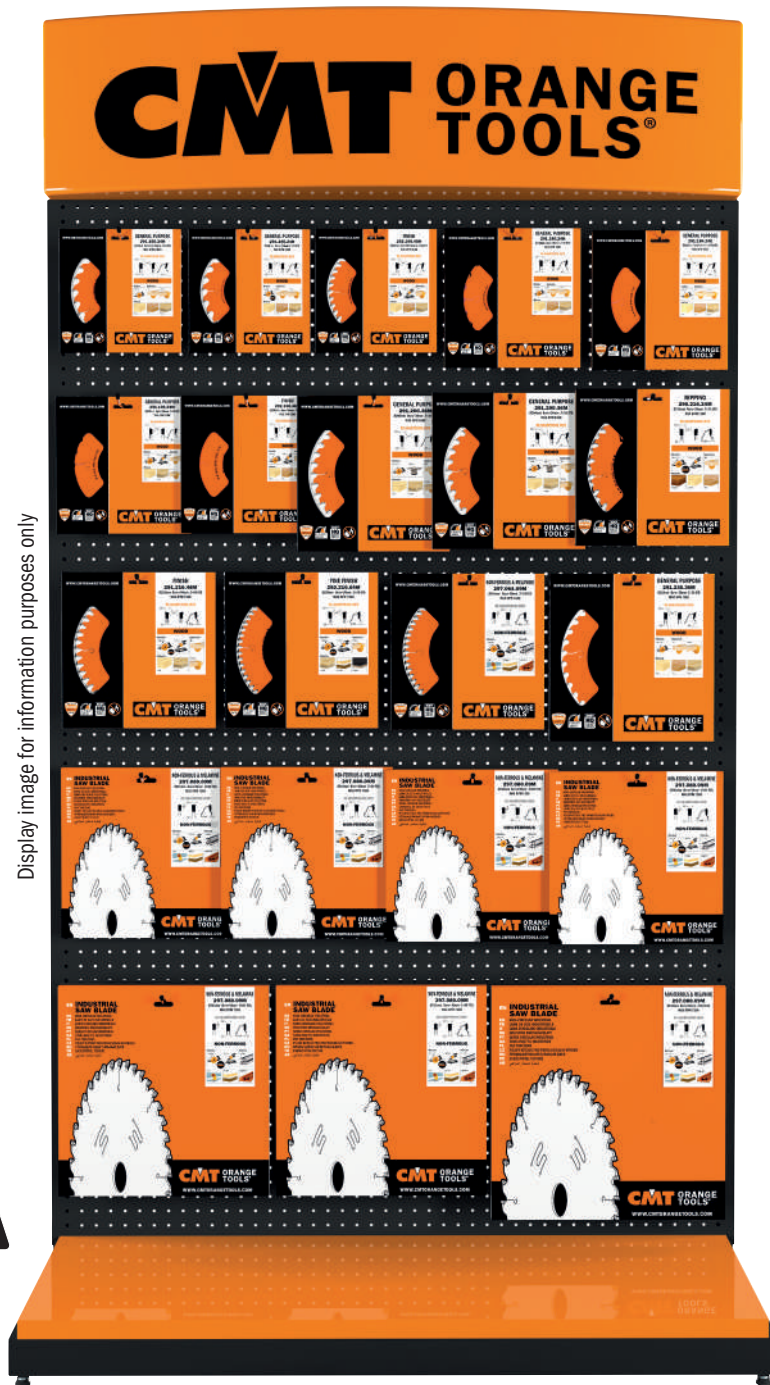

Dimensions: 120 x 45 x 223cm

DISPLAYS THAT SELL!

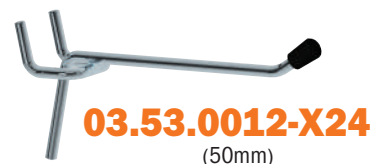

DESCRIPTION	ORDER NO.
Display Cabinet with backlight (220V) for saw blades (blades and hooks not included - sold separately)	03.00.0038
Hooks 50mm. (24 pcs. pack)	03.53.0012-X24
Hooks 150mm. (24 pcs. pack)	03.53.0011-X24
Shelf (380x250x68mm) for CMT display cabinet 03.00.0038 and 03.00.0045	03.53.0038
Lighted header sign CMT ORANGE TOOLS (220V) (spare parts)	03.54.0084
LED TUBE (220V) for sign display (spare parts)	03.54.0097

Display Cabinets for Sabre & Jig Saw Blades



A sturdy steel sabre and jig saw blade display cabinet equipped with a backlight to place anywhere in your store. You can hang and display a variety of different blades. Contact your CMT representative to seek advice on the most suitable blade display composition for your needs. Tools not included. Dimensions in cm.

IMBALLO143 Cardboard counter display for jig saw blades.



CMT's end cap cardboard display for jig saw blades takes advantage of the existing space in your store and is designed for countertops, existing shelves or free-space inside CMT display cabinets. Suitable for stocking up to 12 different jig saw blade types, 10 packs each, 120 packs in total. The end cap cardboard display helps increase product visibility and sell more!

DISPLAYS THAT SELL!

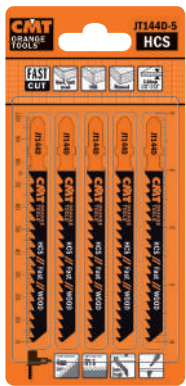

BULK PACK 5 PCS.

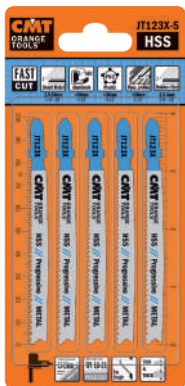

BULK PACK 25 PCS.



BULK PACK 5 PCS.



BULK PACK 20 PCS.

03.53.0020-X12

(50mm, for JS)



03.53.0012-X24

(50mm)

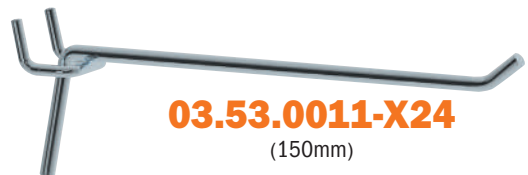

03.53.0011-X24

(150mm)

Dimensions: 120 x 45 x 223cm

Display image for information purposes only

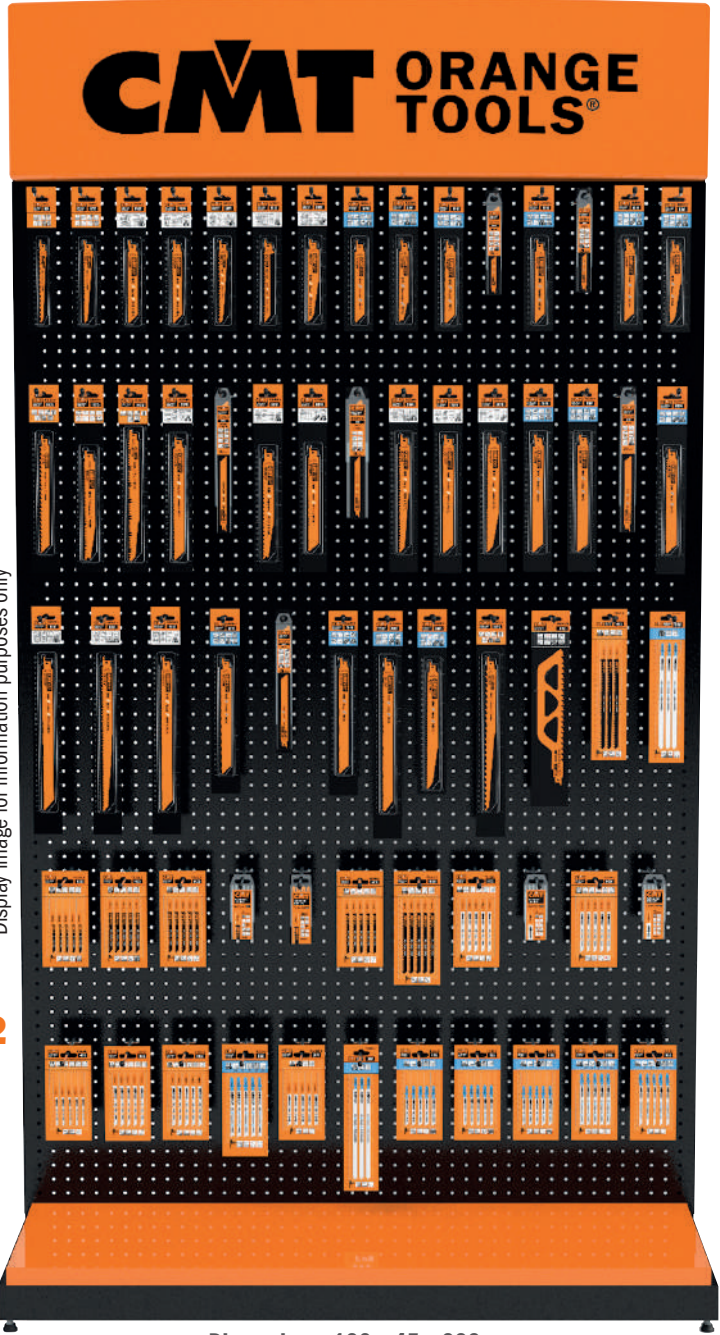

DESCRIPTION	ORDER NO.
Cardboard Counter display only (blades not included)	IMBALLO143
Display cabinet with backlight (220V) for sabre and jig saw blades (blades and hooks not included - sold separately)	03.00.0038
Hooks 50mm. (24 pcs. pack)	03.53.0012-X24
Hooks 50mm. for JS (12 pcs. pack)	03.53.0020-X12
Hooks 150mm. (24 pcs. pack)	03.53.0011-X24
Shelf (380x250x68mm) for CMT display cabinet 03.00.0038 and 03.00.0045	03.53.0038
Lighted header sign CMT ORANGE TOOLS 220V (spare parts)	03.54.0084
LED TUBE 220V for sign display (spare parts)	03.54.0097

Display Cabinet for Multi-Cutters

A sturdy steel multi-cutter display cabinet featuring an attractive backlight to place anywhere in your store. You can hang and display a variety of different cutters. Contact your CMT representative to seek advice on the most effective cutter display composition for your needs. Tools not included. Dimensions in cm.

03.00.0038



CLAMSHELL 1 PCS.
BULK PACK 5 PCS.



03.53.0011-X24

(150mm)



03.53.0012-X24

(50mm)

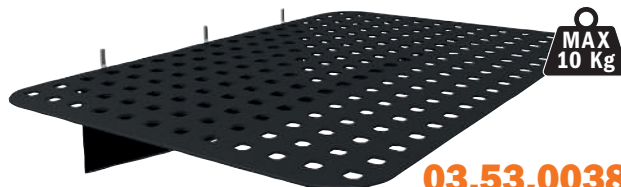

03.53.0038

Minimum order 2-pieces or multiple
For use with display cabinets 03.00.0038 and 03.00.0045

Display image for information purposes only



Dimensions: 120 x 45 x 223cm

DISPLAYS THAT SELL!

DESCRIPTION	ORDER NO.
Display cabinet with backlight (220V) for multi-cutters (tools and hooks not included - sold separately)	03.00.0038
Hooks 50mm. (24 pcs. pack)	03.53.0012-X24
Hooks 150mm. (24 pcs. pack)	03.53.0011-X24
Shelf (380x250x68mm) for CMT display cabinet 03.00.0038 and 03.00.0045	03.53.0038
Lighted header sign CMT ORANGE TOOLS 220V (<i>spare parts</i>)	03.54.0084
LED TUBE 220 V for sign display (<i>spare parts</i>)	03.54.0097

Display Cabinet for Router Bits



This sturdy piece is hand-crafted from MDF, tempered glass and iron. The cabinet is free-standing and provides 360° visibility thereby allowing you to position the display anywhere in your store. The front is a convenient 2 component assembly. The upper section is designed to display 141 of the best selling router bits from the CMT router bit line as well as 20 corresponding spare parts. The lower section can perfectly fit 10 of the most popular boxed sets or saw blades, if required. Glass doors are secured with key lock.

03.00.0042



Deluxe packaging
recloseable and reusable



03.53.0012-X24
(50mm)



03.53.0042-X24
(150mm)



03.53.0017

Tool Shelf (270x209x1,5mm)
Display cabinet accomodates up to 40 shelves.

Display image for information purposes only



Dimensions: 120 x 45 x 223cm

DESCRIPTION	ORDER NO.
Display cabinets complete with: 246 HW router bits (S=Ø6mm), 66 spare parts (your choice of saw blades) and assorted hooks	700.300.00L
Display cabinets complete with: 246 HW router bits (S=Ø8mm), 66 spare parts (your choice of saw blades) and assorted hooks	900.300.00L
21 pcs. HW router bits with shank Ø12mm for our display cabinet (optional)	900.021.00
Display cabinet for router bits and cutter heads (tools and hooks not included - sold separately)	03.00.0042
Hooks 50mm. (24 pcs. pack)	03.53.0012-X24
Hooks 150mm. (24 pcs. pack)	03.53.0042-X24
Tool shelf (270x209x1,5mm) for CMT display cabinet 03.00.0042 (sold separately)	03.53.0017
LED TUBE 220V for sign display (spare parts)	03.54.0097
Set of 2 pieces of 220V LED STRIPS for display cabinet (spare parts)	03.54.0089
Set of 2 metal supports (RH-LH) for light header sign (spare parts)	03.53.0109
Lighted header sign CMT ORANGE TOOLS 220V (spare parts)	03.54.0084

Display Cabinet for Drill & Boring Bits

03.00.0042

Build up your stock of CMT Drill and Boring bits now by ordering this convenient display case! Get organized and keep your tools within reach and visible! Contact your CMT representative for information and get the best advice on choosing the right selection of drill bits for your display from our very broad range. Tools not included. Dimensions in cm.

- Fit Top Selling 120 SKUs.
- Fit up to 20 Deep
- Secured Glass with Key Lock

X-TREME BORING BITS



Display image for information purposes only



03.53.0017

Steel shelf for Drill & Boring bits.
Fit up to 40 shelves into one 03.00.0042 display case.
Fastening screw to secure bits on shelf: 990.010.00

Dimensions: 270 x 209 x 1,5mm



Dimensions:
120 x 31 x 223cm

**DISPLAYS
THAT SELL!**

DESCRIPTION	ORDER NO.
Display Cabinet for Drill and Boring Bits (Shelves, Bits & Screws not included - sold separately)	03.00.0042
Tool Shelf (270x209x1,5mm) for Display Cabinet 03.00.0042 (Bits & Screws not included - sold separately)	03.53.0017
LED TUBE 220V for Header Sign (<i>spare parts</i>)	03.54.0097
220V LED STRIPS (2 pcs. set) for Display Cabinet (<i>spare parts</i>)	03.54.0089
Set of 2 Metal Supports (RH-LH) for Header Sign (<i>spare parts</i>)	03.53.0109
Illuminated Header Sign CMT ORANGE TOOLS 220V (<i>spare parts</i>)	03.54.0084

Display Cabinet for Hole Saws



A sturdy steel hole saw display cabinet complete with a backlight to place anywhere in your store. You can hang a variety of different types of hole saws. Contact your CMT representative to seek advice on the best hole saw display composition for your needs. Tools not included. Dimensions in cm.

03.00.0038

SERIES 550X: MULTI-PURPOSE

HW
10X
LONGER LIFE
5X
FASTER

SERIES 551X: BI-METAL PLUS

BIM
8% Co
2X
LONGER LIFE

SERIES 552: DIAMOND DRY

GRIT
LONG LIFE

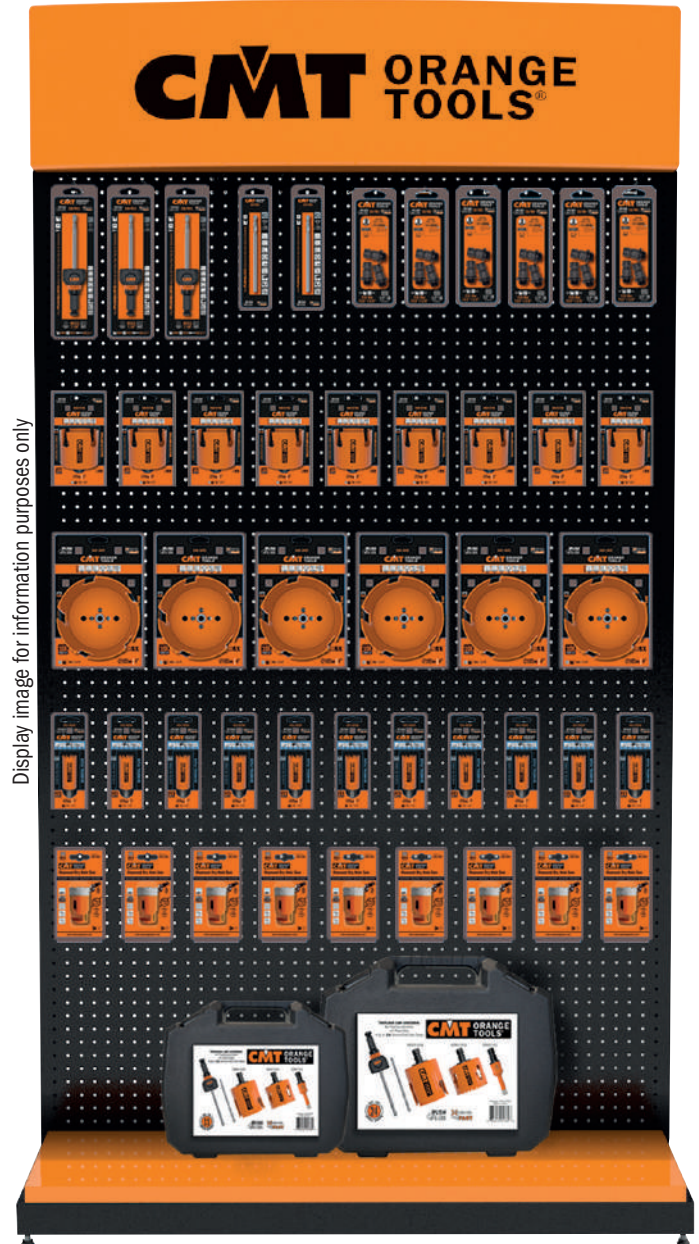

Display image for information purposes only

Dimensions: 120 x 45 x 223cm

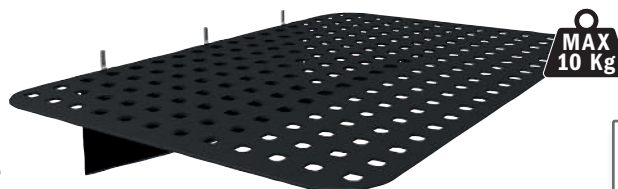

03.53.0038
Minimum order 2-pieces or multiple
For use with display cabinets **03.00.0038** and **03.00.0045**

DISPLAYS THAT SELL!

DESCRIPTION	ORDER NO.
Display cabinet with backlight (220V) (Hole Saws & Hooks not included, sold separately)	03.00.0038
Hooks 150mm. (24 pcs. pack)	03.53.0011-X24
Hooks 200mm. (24 pcs. pack)	03.53.0013-X24
Shelf (380x250x68mm) for CMT display cabinet 03.00.0038 and 03.00.0045	03.53.0038
Illuminated Header Sign CMT ORANGE TOOLS 220V (<i>spare parts</i>)	03.54.0084
LED TUBE 220V for Header Sign (<i>spare parts</i>)	03.54.0097

Display Cabinet for Router Bits & Forstner Bits

A beautiful, well-organized display of router bits in your shop is the best way to encourage customers to buy. CMT has produced this beautiful cabinet to best show off our wide selection of high quality bright orange bits, Forstner bits and boring bits. Made with a sturdy MDF frame and three glass panels, it is the ideal counter-top display. The wooden slat back wall allows for easy bit organization and comes standard with front door lock. Glass door secured with key lock.



Display for Boring & Forstner Bits

Display images for information purposes only



Deluxe packaging recloseable and reusable



Clamshell packaging



03.53.0042-X24 (150mm)



03.53.0012-X24 (50mm)

DISPLAYS THAT SELL!

DESCRIPTION	ORDER NO.
Display cabinet with: 76 HW Router bits (S=Ø6mm), 8 spare parts (2 pcs. each) and assorted hooks	700.084.00
Display cabinet with: 76 HW Router bits (S=Ø8mm), 8 spare parts (2 pcs. each) and assorted hooks	900.084.00
Display cabinet for Router / Forstner bits (Tools & Hooks not included - sold separately)	03.00.0002
Hooks 50mm. (24 pcs. pack)	03.53.0012-X24
Hooks 150mm. (24 pcs. pack)	03.53.0042-X24

Mini Counter Display for Multi Tools

This simple yet attractive counter display will definitely increase sales because it improves visibility. This cabinet shows off a variety of tools: jig saw blades, sabre saw blades, oscillating tools, router bits, Forstner bits, drill bits and hole saws. That's the best way to attract and encourage customers to buy! A sturdy steel body featuring our trademark orange colour makes for an ideal eye-catching counter-top display! Tools not included. Dimensions in cm.

03.00.0043



Dimensions: 35 x 56 x 16cm



Display images for information purposes only

03.00.0045

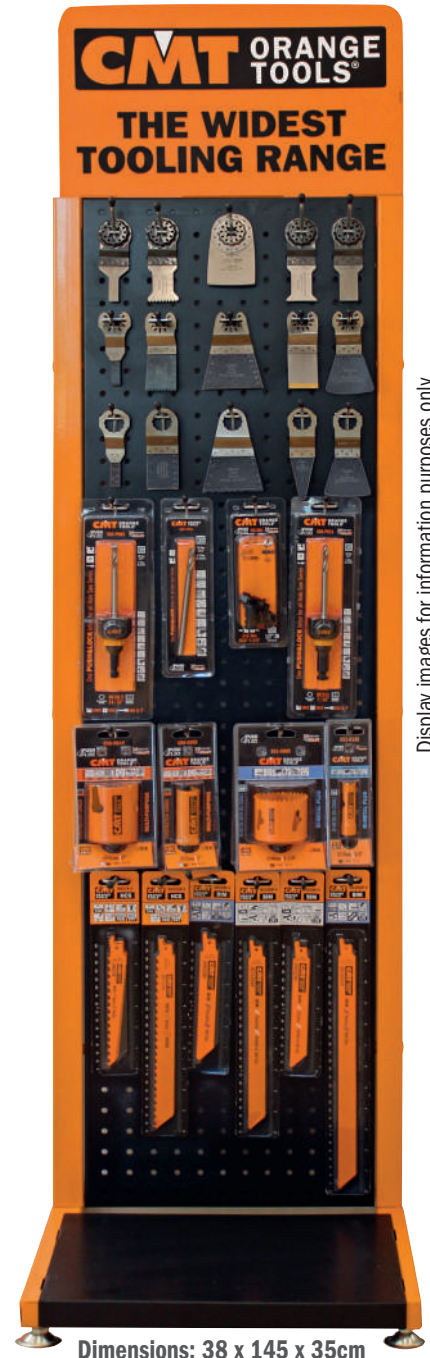

Dimensions: 38 x 145 x 35cm

Display images for information purposes only

03.53.0020-X12

(50mm for JS)



03.53.0014-X12

(50mm for OMM & OMS)

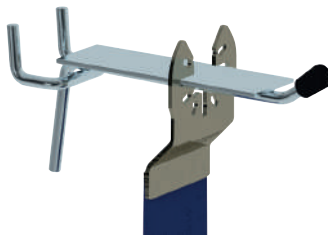

03.53.0012-X24

(50mm)

DESCRIPTION	ORDER NO.
Mini-Counter Display (Tools & Hooks not included - sold separately)	03.00.0043
Medium-sized Display Cabinet (Tools & Hooks not included - sold separately)	03.00.0045
Hooks 50mm. (24 pcs. pack)	03.53.0012-X24
Hooks 50mm. for OMM & OMS (12 pcs. pack)	03.53.0014-X12
Hooks 50mm. for JS (12 pcs. pack)	03.53.0020-X12
Shelf (380x250x68mm) for CMT display cabinet 03.00.0038 and 03.00.0045	03.53.0038

BEARINGS

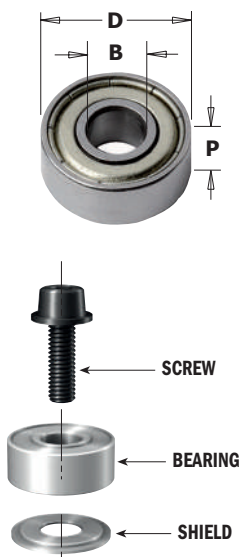

SAFETY RECOMMENDATIONS: be sure to keep the black washer right side up so that it corresponds with the bearing rotation during reassembly.

* After resharpening, always switch to an undersized bearing:

791.062.00 Ø9,3 replaces 791.002.00 (Ø9,5)
791.063.00 Ø12,5 replaces 791.003.00 (Ø12,7)

Sold in 10 pc. case.
Minimum 10 pc. or multiple orders.



**** DELRIN® CYLINDRICAL BEARINGS



** 10° DELRIN® CONICAL BEARINGS



*** DELRIN® TRIANGULAR BEARINGS

D		B		P	Box Icon	ORDER NO.
mm	inches	mm	inches	mm		
6,35	1/4	3,17	1/8	2,8	10	791.035.00
9,3		4,76	3/16	3,17	10	791.062.00*
9,5	3/8	4,76	3/16	3,2	10	791.002.00
12,5		4,76	3/16	4,98	10	791.063.00*
12,7	1/2	4,76	3/16	5	10	791.003.00
12,7	1/2	6,35	1/4	4,8	10	791.010.00
13		5		4	10	791.022.00
13		6		5	10	791.023.00
15		6		5	10	791.024.00
15,8	5/8	4,76	3/16	5	10	791.018.00
15,8	5/8	6,35	1/4	5	10	791.009.00
16		5		5	10	791.006.00
16		8		5	10	791.025.00
19	3/4	4,76	3/16	7,5	10	791.019.00
19		6		6	10	791.007.00
19,05	3/4	6,35	1/4	7	10	791.004.00
19		8		6	10	791.034.00
19	3/4	12,7	1/2	4	10	791.011.00
22		8		6	10	791.012.00
22		8		7	10	791.005.00
22,2	7/8	4,76	3/16	7,5	10	791.017.00
22,2	7/8	9,52	3/8	7	10	791.021.00
22,2	7/8	12,7	1/2	7	10	791.013.00
24		8		8	10	791.036.00
28		8		9	10	791.037.00
28		12		8	10	791.026.00
28,5	1-1/8	4,76	3/16	8,4	10	791.014.00
28,5	1-1/8	8		8,5	10	791.030.00
28,5	1-1/8	12,7	1/2	8	10	791.027.00
31,7	1-1/4	8		5	10	791.033.00
31,7	1-1/4	12,7	1/2	8	10	791.015.00
34,9	1-3/8	4,76	3/16	11,5	10	791.016.00
34,9	1-3/8	8		11,6	10	791.031.00
34,9	1-3/8	12,7	1/2	11	10	791.029.00
37		12		12	10	791.028.00
38,1	1-1/2	12,7	1/2	13,3	10	791.020.00
62		30		16	10	791.051.00
62		35		14	1	791.052.00
80		40		18	1	791.054.00
80		50		16	1	791.053.00
DELRIN® CYLINDRICAL BEARINGS						
12,7	1/2	4,76	3/16	5	10	791.044.00****
15,87	5/8	4,76	3/16	7,2	10	791.045.00****
19,05	3/4	4,76	3/16	6,8	10	791.046.00****
25,4	1	4,76	3/16	6,8	10	791.049.00****
37,4		12,7	1/2	15,7	10	791.047.00****
10° DELRIN® CONICAL BEARINGS						
19	3/4	4,76	3/16	6,8	10	791.041.00**
22	7/8	4,76	3/16	6,8	10	791.048.00**
DELRIN® TRIANGULAR BEARINGS						
12,7	1/2	4,76	3/16	5,8	10	791.042.00***
19	3/4	4,76	3/16	6,8	10	791.043.00***

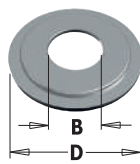

SHIELDS FOR BEARINGS



B	D	Box Icon	ORDER NO.
mm	mm		
4,76	9,5	10	990.422.00
4,76	12,7	10	990.423.00
6,35	19	10	990.425.00
12,7	34,9	10	990.426.00

SCREWS

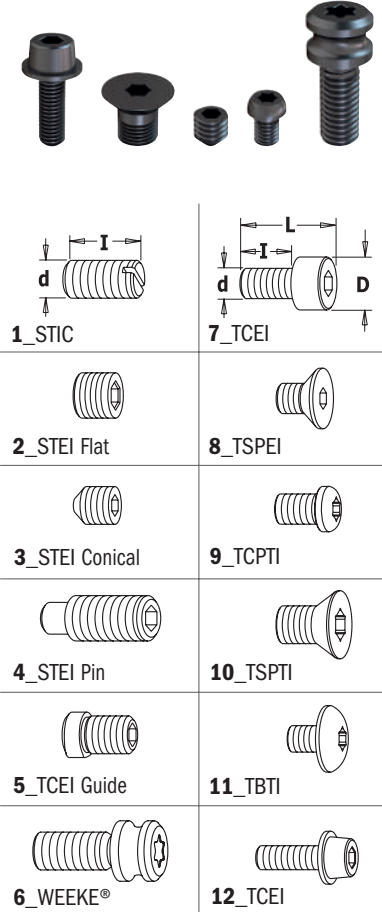

990

		d x l x L mm	D mm	TYPE		ORDER NO.	d x l x L mm	D mm	TYPE		ORDER NO.
1_STIC	7_TCEI	M5x8		1	10	990.008.00	M6x25x31	10	7	10	990.098.00
2_STEI Flat	8_TSPEI	M5x10		1	10	990.003.00	M8x25x33	13	7	10	990.099.00
3_STEI Conical	9_TCPTI	M2x2		2	10	990.060.00	1/8"x1/2"x5/8"	5,5	7	10	990.059.00
4_STEI Pin	10_TSPTI	M4x4		2	10	990.016.00	M5x10x15	8,5	7	10	990.010.00
5_TCEI Guide	11_TBTI	M4x20		2	10	990.091.00	M4x4x6	8	8	10	990.004.00
6_WEEKE®	12_TCEI	M5x4		2	10	990.015.00	M5x9x12	9,8	8	10	990.055.00
		M5x5		2	10	990.001.00	M5x5x8	9	8	10	990.067.00*
		M5x5 p/coppa		2	10	990.006.00	M6x8x10	8,8	8	10	990.083.00
		M3x3		3	10	990.005.00	M6x8,7x12	12	8	10	990.116.00
		M5x5		3	10	990.002.00	1/4"-20x7/8"	12	8	10	990.097.00
		M6x6		3	10	990.007.00	1/8"x3/8"x1/2"	7	12	10	990.058.00
		M4x3		3	10	990.013.00	M5x11,5x17	8 T20	6	10	990.088.00
		M4x4		3	10	990.014.00	M3x4x5,7	4,5 T8	9	10	990.082.00
		M6x5		3	10	990.009.00	M2,5x3x4,5	3,5 T8	10	10	990.070.00
		M6x8		4	10	990.087.00	M2,5x4,5x6	3,7 T8	10	10	990.071.00
		M6x10		4	10	990.106.00	M4x2x3,2	6 T9	10	10	990.079.00
		M6x16		4	10	990.066.00	M5x3,6x6,1	8,8 T25	10	10	990.080.00
		M6x20		4	10	990.084.00	M5x5x8	9 T25	10	10	990.093.00
		M6x25		4	10	990.085.00	M5x13x18	6,8 T15	10	10	990.063.00
		M8x12		4	10	990.065.00	M3,5x3,5x6	6 T15	11	10	990.072.00
		M8x16		4	10	990.064.00	M3,5x4,8x6,8 6	6 T15	11	10	990.115.00
		M8x20		4	10	990.086.00	M4x5,5x8	7,4 T20	11	10	990.094.00
		M5x5x9	6	5	10	990.068.00	M3,5x5x7,2	9 T15	11	10	990.073.00
		M2,5x6x8,5	4,5	7	10	990.062.00	M3,5x6x8,5	7 T15	11	10	990.077.00
		M3x6x9	5,5	7	10	990.051.00	M4x3,5x5,7	9 T15	11	10	990.074.00
		M3x10x13	5,5	7	10	990.053.00	M4x4x6,2	6 T15	11	10	990.076.00
		M3x16x19	5,5	7	10	990.054.00	M4x4x6,2	8,8 T15	11	10	990.056.00
		M4x6x10	7	7	10	990.052.00	M4x6x8	6 T15	11	10	990.078.00
		M4x12x16	7	7	10	990.061.00	M4x6x8,2	9 T15	11	10	990.075.00

* Slotted Head

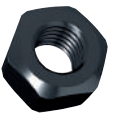

NUTS FOR ARBORS

990.0

	DESCRIPTION		ORDER NO.	DESCRIPTION		ORDER NO.
	M4	10	990.092.00	M8	10	990.020.00
	M6	10	990.095.00	M12x1,25mm	10	990.022.00

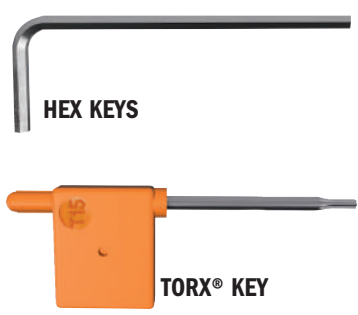

KEYS FOR SCREWS

991

	DESCRIPTION		ORDER NO.	DESCRIPTION		ORDER NO.
HEX KEYS	HEX KEYS			6mm	10	991.066.00
	0,9mm (for screw M2)	10	991.055.00	TORX® KEY		
	1,5mm (for screw M3)	10	991.056.00	T8	10	991.063.00
	2mm (for screw M4)	10	991.060.00	T9	10	991.069.00
	3/32" (for screw 1/8W)	10	991.057.00	T15	10	991.061.00
	2,5mm (for screw M5)	10	991.062.00	T20	10	991.072.00
	3mm	10	991.067.00	T25	10	991.073.00
	4mm	10	991.064.00	T30	10	991.071.00
	5mm	10	991.065.00			

STOP COLLARS

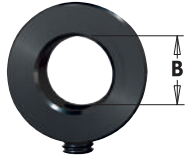
541

	B mm		ORDER NO.	B mm		ORDER NO.
	3,175	10	541.009.00	9,5	10	541.006.00
	6	10	541.003.00	12	10	541.005.00
	6,35	10	541.001.00	12,7	10	541.002.00
	8	10	541.004.00			

ARBORS

797

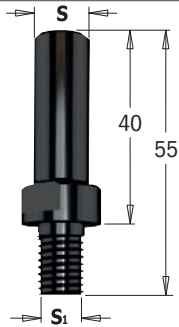

S mm	S ₁ mm			ORDER NO.
8	M10x1,5		10	797.580.00
10	M12x1		10	797.100.00
12	M12x1		10	797.120.00
12,7	M12x1		10	797.127.00

TECHNICAL DETAILS:
 - Strength steel.
 - Precisely machined for accuracy.

COLLET CHUCKS

796

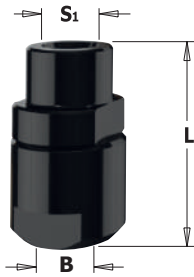

S ₁ mm	B mm	L mm			ORDER NO.
M10x1,5	6 - 6,35 - 8 - 9,5	38		10	796.100.00
M12x1	6 - 6,35 - 8 - 9,5	38		10	796.000.00
M12x1	10 - 12 - 12,7	47		10	796.121.00

TECHNICAL DETAILS:
 - Strength steel.
 - Precisely machined for accuracy.

Collet not included.

ROUTER CHUCK EXTENSIONS WITH COLLET

796.001/002



S mm	COLLET INCLUDED mm	FOR COLLETS mm	L mm			ORDER NO.
12	8	6 - 6,35 - 8 - 9,5	81		10	796.002.01
12	12	10 - 12 - 12,7	88		10	796.002.00
12,7	6,35	6 - 6,35 - 8 - 9,5	81		10	796.001.01
12,7	12,7	10 - 12 - 12,7	88		10	796.001.00

TECHNICAL DETAILS:
 - Strength steel.
 - Precisely machined for accuracy.

Collet included.

COLLET CHUCKS

796

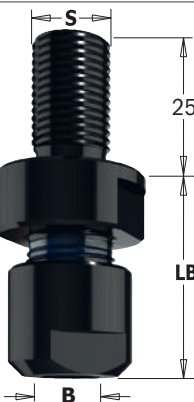

S mm	FOR COLLETS mm	LB mm			ORDER NO.
M14x2	6 - 6,35 - 8 - 9,5	32		10	796.140.00
M14x2	10 - 12 - 12,7	38		10	796.141.00
M16x2	6 - 6,35 - 8 - 9,5	32		10	796.160.00
M16x2	10 - 12 - 12,7	38		10	796.161.00

TECHNICAL DETAILS:
 - Strength steel.
 - Precisely machined for accuracy.

Collet not included.

COLLETS

796.500/600



B mm		ORDER NO.	B mm		ORDER NO.
6	10	796.560.00	10	10	796.600.00
6,35	10	796.564.00	12	10	796.620.00
8	10	796.580.00	12,7	10	796.627.00
9,5	10	796.595.00			

ROUTER CHUCK EXTENSION

796.003

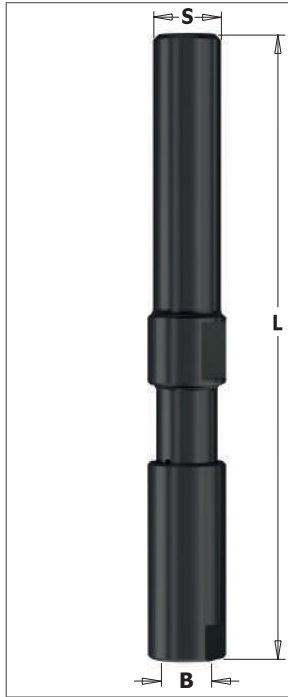

S mm	B mm	L mm		ORDER NO.
12	8	100	10	796.003.08

TECHNICAL DETAILS:
 - High strength resistant steel.
 - Precisely machined for accuracy.

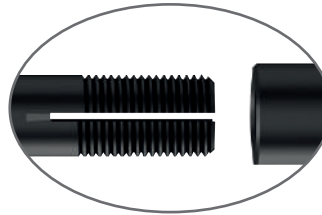

Collet not required

“ER20” CHUCKS

796

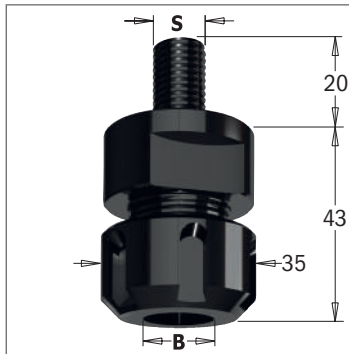

S mm	FOR COLLETS mm	LB mm		ORDER NO.
M12x1,75	3 ~ 12,7	43	10	796.122.00
M14x2	3 ~ 12,7	43	10	796.142.00
M16x2	3 ~ 12,7	43	10	796.162.00

Spare parts: 992.483.03 M25x1,5mm clamping nut
 991.483.00 “ER20” key

TECHNICAL DETAILS:
 - Strength steel.
 - Precisely machined for accuracy.

Collet not included.

SAFETY TIPS



The **TW-200** Torque Wrench is recommended for the proper fastening of clamping nuts (see page 413).

“ER20” PRECISION COLLETS FOR 796.122/142/162

184

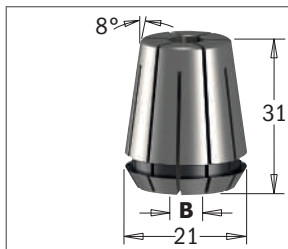

B mm		ORDER NO.	B mm		ORDER NO.
3	10	184.030.20	8	10	184.080.20
5	10	184.050.20	10	10	184.100.20
6	10	184.060.20	12	10	184.120.20
6,35	10	184.064.20	12,7	10	184.127.20

COLLETS FOR CMT1E, CMT2E, DEWALT®, FELISATTI®, FEIN®, METABO® HAND-HELD ROUTERS

796

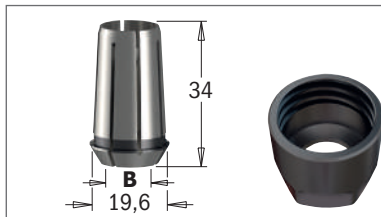

B mm		ORDER NO.	B mm		ORDER NO.
6	10	796.860.00	10	10	796.900.00
6,35	10	796.864.00	12	10	796.920.00
8	10	796.880.00	12,7	10	796.927.00

Spare parts: 992.100.01 M22 Clamping nut

COLLETS FOR FREUD®/CASALS® HAND-HELD ROUTERS

796.780

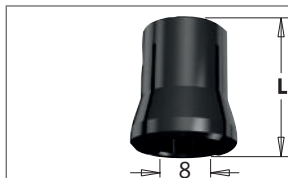

B mm	L mm		ORDER NO.
8	14	10	796.780.00

BUSHINGS

799



B mm	D mm	L mm		ORDER NO.	B mm	D mm	L mm		ORDER NO.
6	8	25	10	799.060.00	8	10	25	10	799.280.00
6	9,5	25	10	799.160.00	8	12	25	10	799.380.00
6	12	25	10	799.260.00	8	12,7	25	10	799.480.00
6,35	8	25	10	799.064.00	9,5	12,7	25	10	799.001.00
6,35	9,5	25	10	799.164.00	10	12	25	10	799.100.00
6,35	12,7	25	10	799.264.00	13	16	45	10	799.130.00
8	9,5	25	10	799.180.00					

REDUCTION BUSHING FOR BEARING

799

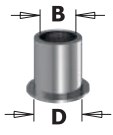

D mm	B mm		ORDER NO.
6,35	4,76	10	799.019.00
7,94	4,76	10	799.017.00
12,7	4,76	10	799.014.00

ARBORS

798

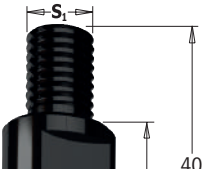

S mm	S ₁ mm		ORDER NO.
M10x1,5	M10x1,5	10	798.101.00
M10x1,5	M12x1	10	798.102.00
M12x1	M10x1,5	10	798.121.00
M12x1	M12x1	10	798.122.00

TECHNICAL DETAILS:

- Strength steel.
- Precisely machined for accuracy.

SLOT CUTTER ARBORS

7/8/924

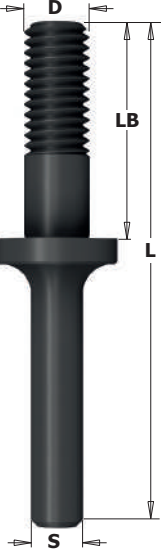

D mm	LB mm	L mm		ORDER NO. S=Ø6mm	ORDER NO. S=Ø6,35mm	ORDER NO. S=Ø8mm	ORDER NO. S=Ø12mm	ORDER NO. S=Ø12,7mm
ARBORS FOR 822 SLOT CUTTERS								
M8	23	71	10				924.133.00	824.133.00
M8	26	61	10	724.060.00	824.064.00	924.080.00		
M8	26	67,5	10				924.120.00	824.127.00
M8	29,75	71	10				924.131.00	824.131.00
M8	35,5	71	10				924.132.00	824.132.00
M8	40	81	10				924.128.00	824.128.00
M8	40	86	10			924.083.00		
M8	41	85	10				924.136.00	824.136.00
M8	47	97	10				924.130.00	824.130.00
M8	57	100	10				924.137.00	824.137.00
M12	39,5	85	10				924.134.00	824.134.00
M12	54	97	10				924.129.00	824.129.00
M12	54,5	100	10				924.135.00	824.135.00

SLOT CUTTER ARBORS

7/8/924

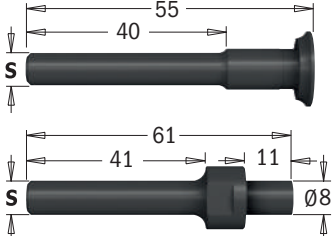



D mm	LB mm	L mm		ORDER NO. S=Ø6mm	ORDER NO. S=Ø6,35mm	ORDER NO. S=Ø8mm	ORDER NO. S=Ø12,7mm
ARBORS FOR 823 SLOT CUTTERS WITH COUNTERBORE							
		55	10	724.061.00	824.061.00	924.081.00	824.121.00
8	11	61	10	724.062.00		924.082.00	824.122.00

SHIELDS FOR ASSEMBLY

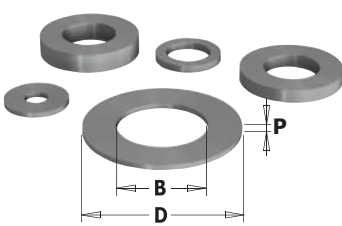
541



B mm	D mm	P mm		ORDER NO.	B mm	D mm	P mm		ORDER NO.
3,25	9	1,6	10	541.550.00	8	14,7	5,8	10	541.519.00
3,25	15,8	2	10	541.552.00	12	20	2	10	541.512.00
5,2	15,8	2,5	10	541.551.00	12	20	3	10	541.511.00
6,4	9,52	2,2	10	541.514.00	12	18	0,1	10	541.526.00
8	14	0,1	10	541.515.00	12	21	0,3	10	541.520.00
8	14	0,3	10	541.516.00	12	21	1,59	10	541.521.00
8	14	0,5	10	541.517.00	12	21	3,18	10	541.522.00
8	14	1	10	541.518.00	12	21	6,16	10	541.523.00
8	14,7	3	10	541.500.00	12	21	1	10	541.524.00
8	14,7	4	10	541.501.00	12	21	0,5	10	541.525.00

SPACERS SET

695.998

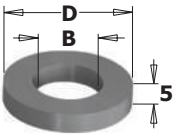

SPACER RING

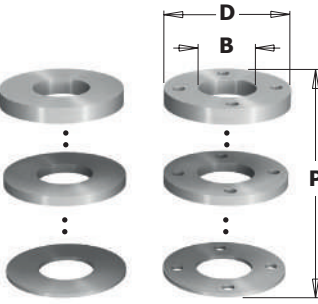



SPACER SETS SPACER SETS WITH PIN HOLE

D mm	B mm	P mm	FOR CUTTER HEAD		ORDER NO.
SPACER RING					
30	60	5	694.021 - 694.022	1	299.560.30
31,75	60	5	694.021 - 694.022	1	299.560.31
35	60	5	694.021 - 694.022	1	299.560.35
40	60	5	694.021 - 694.022	1	299.560.40
50	70	5	694.021 - 694.022	1	299.570.50
SPACER SETS					
50	30	9	694.015	10	695.998.01
50	31,75	9	694.015	10	695.998.02
55	35	9	694.015	10	695.998.03
60	40	9	694.015	10	695.998.04
70	50	9	694.015	10	695.998.05
50	30	33	694.005	10	695.998.11
50	31,75	33	694.005	10	695.998.12
55	35	33	694.005	10	695.998.13
60	40	33	694.005	10	695.998.14
70	50	22	694.005	10	695.998.15
SPACER SETS WITH PIN HOLE					
65	30	8	694.001 & 694.015	10	695.998.21
65	31,75	8	694.001 & 694.015	10	695.998.22
65	35	8	694.001 & 694.015	10	695.998.23

THREADED RINGS FOR 694.001 CUTTER HEADS

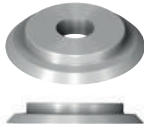
695.996





DESCRIPTION		ORDER NO.
M4 (Ø10x1,6mm)	10	695.996.01
M4 (Ø12x1,7mm)	10	695.996.02

WEDGES FOR CUTTER HEADS

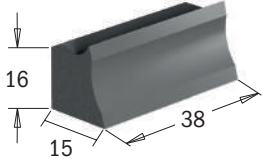
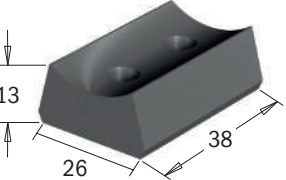
651-692-693-695

DESCRIPTION		ORDER NO.	DESCRIPTION		ORDER NO.
WEDGE FOR CUTTER HEADS					
31x11x9,5mm	10	695.999.31	31x11x9,5mm	10	695.999.31
38x15x16mm	10	692.999.01	38x11x9,5mm	10	695.999.38
38x22,5x13mm	10	692.999.02	39x11x9,5mm	10	695.999.39
38x26x13mm	10	693.999.01	42x11x9,5mm	10	695.999.42
38x15x16mm (for 695.018)	10	695.018.01	46x11x9,5mm	10	695.999.46
7x11x9,5mm	10	695.999.07	49x11x9,5mm	10	695.999.49
16x11x9,5mm	10	695.999.16	53x11x9,5mm	10	695.999.53
17x11x9,5mm	10	695.999.17	WEDGES FOR ROUTER BITS WITH KNIVES		
22x11x9,5mm	10	695.999.22	D=8x20mm	10	651.999.01
23x11x9,5mm	10	695.999.23	D=10-12-12,7x30mm	10	651.999.02
23x11x9,5mm	10	695.999.24	D=12-12,7x50mm	10	651.999.03

Alphabetical index

DESCRIPTION	PAGE
1000W Precision Router.....	392
12 Corner Radius Router Template Set from 3mm to 25mm.....	402
12 Piece Router Bit Set.....	262
13 Piece Multiprofile Cutter Head Sets without Limiters.....	152
13 Piece Router Bit Set.....	262
15 Piece Router Bit Set.....	261
15° Dovetail Cutter with Insert Knives for Roof-Frames.....	220
16 Piece Jig Saw Blade Set.....	89
2 Flute Dowel Drills.....	336-337
2 Flute Dowel Drills for Through Holes.....	342-343
2 Piece Entry Door Router Bit Set.....	265
2400W Precision Router.....	393
25 Piece Reciprocating Saw Blade Set.....	103
26 Piece Router Bit Set.....	261
3-Flute Slot Cutter for STRIPLOX® Mini.....	253
3-in-1 Flush Trim Bits for MDF/Laminate.....	198
3-Wing Slot Cutter.....	207
300W Oscillating Multi-Tools.....	395
3D Router Carver System.....	414-416
4 Flute Dowel Drills.....	338-340
4 Flute Dowel Drills for Through Holes.....	343
4-Wing Cut Out Slot Cutters for Solid Surfaces.....	257
45° Chamfer Cutter Heads.....	138
45° Countersink with Parallel Shank.....	372
45° Lock Miter Cutter Heads.....	145
5 Piece Basic Router Bit Set, Contractor.....	279
5 Piece Boring Bit Set for Hinges.....	358-359
5 Piece Spiral Bit Set.....	271
5 Piece Straight Bit Set & Profile Bit Set.....	270
5 Piece Straight Router Bit Set, Contractor.....	279
5% Co HSS Spiral Bits for Aluminium Positive Single Flute.....	187
550W Trimmer.....	394
6 Piece Mortising Bit Sets.....	320-321
60° Lettering Bit.....	221
7 Piece Multiprofile Cutter Head Sets with Limiters.....	153
9° Dovetail Cutters.....	220
90° Countersink with Parallel Shank.....	372
90° Solid Carbide Countersink with Driving Flat.....	344
90° Solid Carbide Countersink with Parallel Shank.....	373
A ccessories for Multi-Cutters.....	121-130
Adaptors.....	345-347, 356-357
Adaptors for Twist Drills.....	335
Additional Templates, Bits & Accessories.....	405
Adjustable Chamfer Cutter Heads ±45°.....	139
Adjustable Chamfering CNC Cutter.....	315
Adjustable Corner Frame Clamps.....	403
Adjustable Countersink.....	370
Adjustable Double Roundover Router Bits.....	238
Adjustable Grooving Cutter Heads Sets (2 pcs.).....	135
Adjustable Grooving Cutter Heads Sets (3 pcs.).....	134
Adjustable Precision Router Dado Jig.....	401
Adjustable Rounding & Chamfering Cutter Heads Sets (2 pcs.).....	137
Adjustable Roundover & Bevel Router Bits.....	238
Adjustable Scoring.....	50
Adjustable Shaker Router Bit Set.....	269
Adjustable Tongue & Groove Bit Set for Mission Style Cabinet Doors.....	269
Adjustable Torque Screwdriver Set 1-6 Nm.....	413
Auger Bits.....	367
B ack-to-Back Connectors for Straight Edge Clamps (optional).....	400
Ball End Bit.....	228
Bead & Bull Nose Bits.....	240
Beading Bits.....	231
Bench Block Set.....	422
Bi-Metal Plus Hole Saws.....	382-383
Biscuit Joiner.....	69
Bit Organizer.....	422
Blank Knives & Limiters (to be sharpened).....	167
BLUM® Hinge Boring Head.....	412
Boring Bit & Plug Cutter Sets.....	363
Boring Bits with Parallel Shank.....	358-361
Boring Head System 32.....	412
Bowl & Tray Bits.....	221
Bowl & Tray System.....	417
Brad Point Bit Sets.....	368
Brad Point Bits.....	368-369
Brad Point Bits & Stop Collars.....	367
Bushings for Twist Drills.....	335

DESCRIPTION	PAGE
C -Spanner.....	288
Calibration & Sanding Disks.....	71
Cap Nuts for CNC Machines.....	285
Carbide Spiral Slot Mortising Bits with Chipbreaker.....	322
Carpenter Pencil & Ink Pen.....	424
Cavetto Edge Mould Bits.....	230
Chamfer Bit, Contractor.....	276
Chamfer Bits.....	225-226
Chamfer Bits with Insert Knives.....	225
Chamfer Set.....	226
Chucks & "ER20" Collets for Spindle Moulder Machine.....	167
Chucks for "ER32" Precision Collets.....	285
Chucks for Biconical Collets with MK2 Tapered Shank.....	285
Clamping Nuts.....	287
Classical Bead Bits.....	234
Classical Ogee Bits.....	236
Classical Ogee Bits, Contractor.....	278
Clearing grass, bushes, small trees.....	70
CMT Moulding System.....	241
CMT Professional Tool Bag.....	424
CMT's Complete Kitchen Set.....	267
Combination Trimmer Bits.....	194-195
Complete Set for Decorating on MDF.....	317
Complete Set for MDF Doors.....	318-319
Conical Scoring.....	51
Construction.....	10
Contour Duplicator Gauge.....	403
Contractor.....	14-15
Corner Beading Bit with 45° Chamfer.....	239
Corner Beading Bits.....	240
Countersinks for 2 Flutes Dowel Drills.....	344
Countersinks for 4 Flutes Dowel Drills.....	344
Countersinks with Threaded Shank.....	370
Cove Bit Set.....	229
Cove Bits.....	229
Cove Bits, Contractor.....	277
Cutter Arbor Chucks with Tapered Shank.....	290
Cutter Heads for Rabbeting & Profile Knives 40mm.....	132
Cutter Heads with Limiters.....	151
Cutter Heads without Limiters.....	151
Cutting & Scraping Accessories for Multi-Cutters.....	118
Cutting Accessories for Multi-Cutters.....	109-115
D ado & Planer Bits.....	191
Dado Grooving.....	64
Decorative Beading Bits.....	234
Decorative Ogee Bit, Contractor.....	275
Decorative Ogee Bits.....	233, 235
Deep Hole Mechanical Marker.....	425
Demolition.....	11
Diamond Dry Hole Saws.....	384-385
Diamond Dry Special Bits.....	386-387
Diamond Dry Wheels.....	387
Diamond Whetstones.....	421
Digital Angle Finder.....	419
Digital Angle Gauge.....	419
Digital Height Gauge.....	418
Digital Moisture Meter.....	418
Display Cabinet for Drill & Boring Bits.....	432
Display Cabinet for Hole Saws.....	433
Display Cabinet for Multi-Cutters.....	430
Display Cabinet for Router Bits.....	431
Display Cabinet for Router Bits & Forstner Bits.....	434
Display Cabinets for Sabre & Jig Saw Blades.....	429
Display Cabinets for Saw Blades.....	428
Divided Light Door Set.....	263
Door Lip Bit & Finger Grip Bit.....	244
Double-Bearing Spiral Flush Trim Bits.....	198
Double-Edge Trimmer.....	420
Dovetail Bit, Contractor.....	276
Dovetail Bits.....	218-219
Dowel Drills - LONG LIFE SHARPENING.....	332
Dowel Drills for MAFELL® & Hand-Held Routers.....	366
Dowel Drills for Through Holes - LONG LIFE SHARPENING.....	333
Dowel Drills for Through Holes with Countersink.....	341
Dowel Drills with Countersink.....	341
Dowel Drills with Threaded Shank.....	353
Dowel Drills with Threaded Shank with Countersink.....	352, 354
Dowel Drills with Threaded Shank without Countersink.....	352, 354

DESCRIPTION	PAGE
DP - Conical Scoring - LONG LIFE	52
DP - Corner Rounding Router Bits for composites and laminates.....	233
DP - Flush Trim Bits for Laminates - LONG LIFE	197
DP - Hinge Boring Bits - LONG LIFE.....	349
DP - Laminated & Chipboard - LONG LIFE.....	52
DP - Multi-Material - LONG LIFE.....	53
DP - Router Cutters - LONG LIFE	304
DP - Router Cutters with 20° Shear Angle - LONG LIFE	306
DP - Router Cutters with 40° Shear Angle - LONG LIFE.....	308
DP - Router Cutters with 45° Shear Angle - LONG LIFE.....	305
DP - Router Cutters with Negative Shear Angle - LONG LIFE.....	304
DP - Router Cutters with Shear Angle - LONG LIFE	305-306
DP - Router Cutters with Shear Angle for Nesting - LONG LIFE	307
DP - Spiral Router Cutters with Shear Angle - LONG LIFE	307
DP - Ultra-Hard Materials - LONG LIFE.....	13, 15
Drawer Lock Bits.....	213
Drill Bit with Countersink for Screw Joints.....	373
Drill Bits for ANUBA® Hinges.....	369
Drill Bits with 45° Countersink Set.....	371
Drill Bits with 90° Countersink Set.....	371
E dge Banding Bits Set.....	217
Edge Banding End Trimmer.....	420
Edge Banding Iron	420
Edge-Fluting Bits.....	241
Entry & Interior Door Router Bit Set	264
ER20 Precision Collets for Chucks 796.122/142/162	167
Extension for drills with hexagonal shank.....	357
F ILE-FREE Flush Trim Bits for Laminate.....	199
Fine Finishing.....	32-33, 36
Fine Finishing - DOUBLE SIDED	34-35
Fine Finishing - THIN KERF.....	37
Finger Joint Bit.....	216
Finger Pull Bit.....	245
Finger Pull Bit, Contractor.....	279
Finishing.....	28-30
Finishing - THIN KERF	31
Flexible Templates for Curved & Arched Routing	402
Flooring Router Bits	206
Flush Trim Bit Set	196
Flush Trim Bits.....	196
Flush Trim Bits with Insert Knives.....	199
Flush Trim Bits, Contractor.....	274
Flush Trim Router Bits with Double Bearing	200
Flute & Bead Set	210
Formula 2050: Blade & Bit Cleaner	423
Formula 998: Lubricant for Wood, Neutralizes Resin	423
Forstner Bit Sets.....	364
Forstner Bits	364
G lass Panel Set.....	263
Grand Rabbeting Bits with Insert Knives	203
Grinding Wheels for XTreme Sharpening.....	330, 332
Grinding, Scraping & Separating Accessories for Multi-Cutters.....	116
Grooving.....	67
Grooving System	68
Grooving/Finish	66
Guide to Choosing the Most Suitable Jig Saw Blade	84
H andle for Reciprocating Saw	103
Hinge Boring Bits.....	349, 351
Hinge Boring Bits with Chipbreaker.....	350
Hinge Recesser Bits.....	191
Hole Saw Adaptors	379
Hole Saw Arbors, Pilot Drills & Kit.....	378
HS Corrugated Back Moulder Knives - Industrial Series	169
HSK Chucks for Grooving Blade	289
HSK-63F Chucks for "E0C25" Precision Collet "DING388"	283
HSK-63F Chucks for "ER32" Precision Collets.....	283
HSK-63F Chucks for "ER40" Precision Collets	283
HSK-63F Chucks for Shrink Fit Holders	283
HWM Reversible knives.....	172-173
HWM Reversible Knives for Portable Planers	168
I ndustrio Routing System.....	397
Inlay Kit	406
Interchangeable Boring Bits with Threaded Shank	357
Interchangeable Torque Wrench 20-200 Nm	413

DESCRIPTION	PAGE
ISO30 Chucks for "ER32" Precision Collets	284
ISO30 Chucks for "ER40" Precision Collets	284
ISO30 Retaining Studs.....	288
J ig Saw Blades.....	85-89
Junior Ogee Rail & Stile Set.....	247
K eyhole Bit, Contractor.....	275
Keyhole Bits.....	205
Kinetic Dust Extractor	282
Kit for CNC Machine	316
Kitchen Set.....	268
Kitchen Worktop Jig.....	407
L aminate/Veneered-Panel Cutter.....	420
Laminated & Chipboard.....	47
Laminated & Chipboard - LONG LIFE SHARPENING - NEGATIVE	45
Laminated & Chipboard - LONG LIFE SHARPENING - POSITIVE.....	44
Laminated & Chipboard - POSITIVE	42-43
Laminated & HPL.....	46
Laser Point Bit.....	223
Latex Coated Gloves	424
Lock Miter Bits	211
Lock Miter Set	210
LOCKED Dado Pro.....	65
M aximize Your HW Saw's Performance	4
Maximizing Boring Performance.....	328, 348
MEDIUM/THICK - Metal & Steel	61
Metal & Steel	58-59
Mini Counter Display for Multi Tools	435
Mortise Chisel & Bit Sets	361
Mortising Bits	190
Moulding Bits	243-244
Multi-Materials Carbide Wheel for Angle Grinder.....	12, 388
Multi-Materials Diamond Dry Wheel for Angle Grinder	12, 389
Multi-Purpose Hole Saws.....	380-381
Multi-Rip.....	19
Multi-Rip with Rakers.....	18
Multi-Rip with Rakers - THICK KERF	17
Multi-Rip with Rakers - THIN KERF.....	16
Multiprofile Bits.....	242
Multiradius Roundover & Cove Cutter Heads.....	142
Multiradius Roundover Cutter Heads.....	140-141
N on-Ferrous & Melamine	55-56
Non-Ferrous & Melamine - THIN KERF	57
Non-Ferrous & Plastics.....	54
O gee Bits.....	237
Ogee with Fillet Bits.....	237
Ovolo Bit, Contractor	277
Ovolo Bits.....	230
Ovolo Sash Bits	215
Ovolo Sash Set.....	215
P air of Bore Reducers.....	167
Panel Sizing	267
Panel Pilot Bits with Guide.....	201
Panel Sizing	48
Panel Sizing - DPX.....	49
Pattern Bits.....	192
Pattern Bits, Contractor	274
Pattern Router Bits with Insert Knives	193
Pattern Router Bits with Insert Knives for Laminates.....	193
Pattern/Flush Trim Bits with Insert Knives.....	200
Planer & Jointer Knives	170-171
Planing & Jointing Spiral Cutter Heads.....	136
Plastics.....	63
Plug Cutters	362
Plunge Ogee Bits	235
Plywood Groove Set	184
Pocket-Pro Joinery System	399
Precision Collets "DIN6388"	287
Precision Collets "DIN6499".....	286
Professional Adjustable Chamfer Cutter Heads ±90°	139
Professional Finger Joint Bit.....	216
Professional Finger Joint Cutter Heads.....	143
Professional Raised Panel Cutter Heads.....	147

Alphabetical index

DESCRIPTION	PAGE
Professional Router Table	396
Professional Straight Edge Clamps.....	400
Profile & Counter Profile Cutter Head Sets	148-149
Profile Knives and Limiters.....	154~166
R abbeting Bit, Contractor	277
Rabbeting Bits.....	203
Rabbeting Bits with Insert Knives.....	204
Rabbeting Cutter Heads with Shear Angle.....	133
Rabbeting Sets.....	204
Rail & Stile Cutter Heads.....	150
Rail & Stile Set.....	247, 249
Raised Panel Bit with Back Cutter.....	251
Raised Panel Bits.....	250
Raised Panel Cutter Heads	146
Rasp & Cutting Tools for Multi-Cutters	117
Reciprocating Slot Mortising Bits.....	324~326
Reduction Rings for Saw Blades.....	71
Replacement Bearing Set	279
Reverse Glue Joint Bits	212
Reverse Glue Joint Cutter Heads.....	144
Ripping.....	20~22
Ripping - THIN KERF	23
Ripping & Crosscut [General Purpose]	24~26
Ripping & Crosscut [General Purpose] - THIN KERF	27
Roman Ogee Bit, Contractor	278
Roman Ogee Bits.....	236
Rosette Cutters.....	365
Round Nose Bits.....	227
Round Nose Bits, Contractor.....	274
Round Nose Set.....	228
Round Nose Solid Carbide Upcut Spiral Bits.....	302
Roundover & Beading Bits, Contractor	278
Roundover Bits	232
Roundover Bits with Insert Knives	231
Roundover Set.....	232
Router Bit Set with Insert Knives.....	271
Router Bits for DOMINO® Joining Machines by FESTOOL®	366
Router Cutters	309~311
Routing Guide.....	176
S abre Saw Blade Application Chart.....	92-93
Sabre Saw Blades.....	94~102
Sanding & Polishing Accessories for Multi-Cutters.....	120
Saw Blade Arbor with Parallel Shank	288
Saw Blade Index	72~82
Saw Blades Stabilizers.....	71
Screw Slot Bits	206
Set of 2 Magnetic Knife Setting Jigs	169
Slot & Mortise Boring Bits.....	322-323
Slot Cutter Set.....	270
Slot Cutters.....	208-209
Slot Cutters, Contractor	276
Slot Mortising Bits	326
Slot Mortising Bits with Chipbreaker	320
Small Arch Door Set	266
Small Stock Holder.....	398
Solid Carbide Dowel Drills - LONG LIFE SHARPENING.....	329~331
Solid Carbide Dowel Drills for Through Holes - LONG LIFE SHARPENING	331
Solid Carbide Downcut Spiral Bits	297
Solid Carbide Downcut Spiral Bits - LONG LIFE.....	295
Solid Carbide Downcut Spiral Bits with Chipbreaker	299
Solid Carbide Router Cutters.....	309-310
Solid Carbide Spiral Bits.....	181, 293
Solid Carbide Spiral Bits - LONG LIFE	180
Solid Carbide Twist Drills "V" Point 120° - LONG LIFE SHARPENING.....	334
Solid Carbide Twist Drills "V" Point 60° - LONG LIFE SHARPENING.....	334
Solid Carbide Twist Drills Negatively Ground Spurs - LONG LIFE SHARPENING	334
Solid Carbide Upcut & Downcut Spiral Bit with DLCS Chrome Coating - LONG LIFE.....	299
Solid Carbide Upcut & Downcut Spiral Bits - LONG LIFE	292
Solid Carbide Upcut 2D/3D Carving Tapered Ball Nose Spiral Bits.....	302
Solid Carbide Upcut Spiral Bits.....	294, 296, 298
Solid Carbide Upcut Spiral Bits for Aluminium and PVC	187
Solid Carbide Upcut Spiral Bits for Locksets.....	300
Solid Carbide Upcut Spiral Bits with Chipbreaker.....	298
Solid Carbide Upcut Spiral Bits with Chipbreaker for 60° V-Point Locksets	300
Solid Surface.....	63
Solid Surface - Bevel Bit	256
Solid Surface - Bevel Bowl Bits	256

DESCRIPTION	PAGE
Solid Surface - Counter-Top Trim Router Bits	253
Solid Surface - Cut & Plug Repair Set	257
Solid Surface - Decorative Edge Profile Bits	254
Solid Surface - Drainboard Bits	259
Solid Surface - Inlay Bits	259
Solid Surface - No-Drip Bit	258
Solid Surface - Rounding Over Bits	254
Solid Surface - Rounding Over Bowl Bit (ogee profile)	255
Solid Surface - Rounding Over Bowl Bits.....	255
Solid Surface - Sink & Trim Bits.....	260
Solid Surface - Sink & Trim Bits with Insert Knives - LONG LIFE	260
Solid Surface - Wavy Joint Bit	258
Solid Surface & Fiberglass Bit with DLCS Chrome Coating - LONG LIFE.....	303
Spare Parts for Cutter Arbor Chucks.....	290
Special Blades for Multi-Cutters & Sets	119
Spiral Bits with Insert Knives & Chipbreaker for Locksets.....	301
Spoilboard Surfacing Router Cutters	313
Spoilboard Surfacing Router Cutters with Insert Knives.....	313
Stainless Steel.....	62
Stepped Rebate Router Bit	224
Stile & Panel Router Bits	252
Stop Collars with DELRIN® Sleeve.....	371
Straight Bits.....	184
Straight Bits - Short Series	185
Straight Bits for Industrial Nesting Application DLCS Chrome Coating - LONG LIFE SHARPENING....	308
Straight Bits with Centre Tip	182
Straight Bits with Centre Tip, Contractor	273
Straight Bits, Contractor	273
Straight Bits, Long Series.....	183
Straight Cutters with Threaded Shank	186
Straight Router Bits with Insert Knives	188-189
Straight Router Bits with Insert Knives for Laminates.....	188
Straight Router Cutters with Insert Knives	312
Super-duty Flush Trim Bit - XTREME Series.....	197
T -Slot Bits.....	205
Table Edge & Hand Rail Bits.....	246
Tabletop Accessories	398
Template Guide Kit.....	406
Tenon Cutting Router Bits	265
The ABC's of Panel Door Construction.....	248
The Cabinetmaking Set.....	266
The CMT Grand Rabbet Set.....	202
The Raised Panel Set with Backcutter.....	268
THIN - Metal & Steel.....	60
Tongue & Groove Set	207
Toolcase for XTREME FAST Hole Saws	390
Tools for Multi-Cutters	106~108
Twisted Slot Mortising Bits with Chipbreaker.....	321
U ltra Fine Finishing	38-39
Ultra Fine Finishing - LONG LIFE SHARPENING	41
Ultra Fine Finishing - FRAMES.....	40
Universal Assembly Supports for Chucks	290
Universal Boring Jig.....	409
Universal Boring Template	408
Universal Dovetail Jig.....	404
Universal Hinges Boring System	410-411
Universal Profile Cutter for CNC Machines.....	314
Upcut Spiral Bits with Chipbreaker for Glue-Laminated Wooden Beams.....	301
V -Groove - Folding - Signmaking CNC Router Cutters with Insert Knives	315
V-Groove Bits, Contractor.....	275
V-Grooving & Signmaking Router Bits with indexable knives (90°).....	224
V-Grooving Bits	223
V-Grooving Bits (90°).....	222
V-Tongue & Groove Set	217
Vertical Raised Panel Bits.....	246
W ainscot/Paneling Bits	239
Weatherseal Bits.....	194
What work parameters are best when routing?.....	280
Window Sash Set.....	214
Window Sill & Finger Bits	245
X Treme Plunge CNC Cutters with Insert Knives.....	312
XTreme Spoilboard Surfacing Router Cutter with Insert Knives.....	314

Numerical Index



ORDER NO.	PAGE	ORDER NO.	PAGE	ORDER NO.	PAGE	ORDER NO.	PAGE	ORDER NO.	PAGE
01.02	330, 332	183.420	289	295	29, 44	366	342	552-0	384
03.00.0002	434	183.421	289	296	55-56	367	343	552-001-05	384
03.00.0038	428-430, 433	183.422	289	297	55-56	368	343	552-115	387
03.00.0042	431-432	184	167, 286, 439	298	70	369	349, 351	552-5	385
03.00.0043	435	185	287	299	135	369C	350	552-501-06	385
03.00.0045	435	186	187	299	71	370	351	552-508M	386
03.51	422	188	187	299.10	71	372	340	552-CS	387
03.53.0011-X24	428-431, 433	189	187	299.11	71	373	340	552-EX14	385
03.53.0012-X24	428-430, 434-435	190	180, 292			374	343	552-GUIDE	385
03.53.0013-X24	433	190.04	299	300.023.01	316	375	343	552-M	386
03.53.0014-X12	435	190.41	180, 292	300.025.01	316	376-377	341	552-WAX	384
03.53.0017	431-432	190B	198	301	345	378	341		
03.53.0020-X12	429, 435	191	181, 294	302	345	380	366	600.005.01	271
03.53.0038	430, 433	191.0	271	303	346	381	343	615.004.01	318-319
03.53.0042-X24	431, 434	191.143/163	300	305	345	382	331	615.200D	318
		191.635	194	306	338	392	361	615.350C	318
102	320	191B	198	307	338			615.500B	318
103	324	192	181, 295	308	339	500.001.08	363	615.620A	318
104	325	192.0	271	309	339	500.002.08	363	616.000.01	317
105	325	192.41	295	310	336	500.003.08	363	616.120	317
106	326	192B	198	310.21/22	330	501	357	616.200	317
107	326	193	296	310.41/42	332	503	356	651	188, 441
112	310	194	297	311	337	506	356	652	188
113	310	195	298, 300-301	311.21/22	330	507	357	652B	193
123	285	195.143/163	300	311.31/32	329	509	356	653	189, 312
124	285	196	299	311.41/42	332	511	356	654	189
140	305	197	298	311.71/72	329	512	358-359	655	189
141	304	198	180, 293	312	366	512.001.00	359	656	193
142	306	199	227, 302	313	342	512.001.01	358	657.1	199
143	307			313.41/42	333	513	360	657.9	199
145	308	222	63	314	342	514	360	657B	200
151	303	223	63	314.21/22	331	515	369, 372-373	658	225
152	302	226	60-62	314.41/42	333	515A	371	660	204
160	321	227	58-59	315	344	516	369	660.9	203
161	321-322	230.312	65	316	344	517	368	661.11	231
163	322	230.5	64	317	349, 351	521	344, 372-373	661.41	231
164	323	235	53	317C	350	521.001	370	662	301
166	323	236	13	325	352	521A	371	663.0	313
167	323	237	52	327	352	522	220	663.1	315
170	186	238	52	329	352	523	220	663.201	315
171	186	240	66-69	330	352	529	362	663.301	314
172	320	240.004.04	69	332	354	531	365	663.5	314
173	186	241	69	334	354	532	356	664	220
174	182, 309	271	23, 27	336	354	533	356	665	224
175	311	272	31	337	354	534	347	690	154-167
176	311	273	37	338	352	537	364	691	154-167
177	182, 311	274	41	339	352	537.000.04	364	692	151-152, 441
178	313	276	57	340	352	537.000.05	364	693	151, 153, 441
179	324	277	17-18	341	354	537.000.07	364	694.001	134
180	186	278	19	342	354	537.000.12	364	694.002	138
181	186	280	16	343	354	537.000.16	364	694.003	140
182	186	281	42-43, 45-48	344	353	540	367	694.004	141
183	290	282	48-49	346	353	541	367, 371, 437, 441	694.005	137
183.000	285	283	39	350	370	542-535	367	694.007	142
183.075	283	283.6	38	351	370	543	361	694.008	143
183.100	285	284	54	352-353	353	550-PA01	379	694.009	144
183.200	284	285	20-21, 25-26, 28-30, 32-33, 36	358	345	550-PA02	379	694.011	145
183.201	284	285.5	40	359	346	550-PA03	379	694.012	146
183.210	284	285.6	24	360.001	346	550-PA04	379	694.013	147
183.211	284	286	10-12, 388	360.101	347	550-PA05	379	694.014	150
183.220	284	286.61	12	360.201	347	550-PA06	379	694.015	148-149
183.221	284	286.61	389	360.301	347	550-PD01	378	694.017	139
183.250	284	287	34-34	360.401	347	550-PD02	378	694.018	139
183.260	290	288	51	361	336	550-PH85	378	694.019	136
183.300	283	289	50	362	337	550-PH11	378	694.020	132
183.310	283	290	22	363.11/12	334	550-PHSD	378	694.021	135
183.320	283	291	26	363.21/22	334	550CSX	381	694.022	135
183.360	290	292	30, 36	363.41/42	334	550X	380-381	694.100	133
183.400	285	293	21	364	335	551X	382-383	695	441
183.410	288	294	25, 29-30, 36	365	335	552	384	695.996	441

Numerical Index

ORDER NO.	PAGE	ORDER NO.	PAGE	ORDER NO.	PAGE	ORDER NO.	PAGE	ORDER NO.	PAGE
695.998	441	790	168, 172-173	822.024B	206	857	226	900.626	207
699	167	791	436	822.033B	257	858	223	900.627	265
		791.703	204	822.034	253	859	237	900.628	265
700.005.03	270	79101	279	822A	208	860	237	901	190
701	190	792	170	822B	208	861	240	901B	190
701B	190	793	169	823	209	861.6	239	902	191
702	191	795	171	823.001	270	862	241	903	225
703	225	796	167, 438-439	823.371	253	863	230	904	225
704	225	796.001	438	823B	209	864	230	905	225
705	225	796.003	439	824	209, 440	865	234	906	196-197
706	196-197	796.500/600	438	824.xxx.00	208	865.1	235	906B	197
707	195, 198	796.780	439	824.xxx.10	208	865.9	233	906B	200
709	195	797	438	827	230	865B	234	907	195, 198-199
710	195	798	440	835	203	866.501	256	909	195
711	184-185	799	440	835.001	204	866.6	255	910	195
711.031	194	799.517	202-203	835.501	204	867.5B	244	911	184-185
711B	192			835.503	202	867.6B	244	911B	192
712	183	800.001	261	835.990	202	867.701	243	912	182-183, 308
712.030	194	800.503	262	836	226	868	228	912B	192
712.040	194	800.505	262	837	229	870	252	913	206
712B	192	800.506	207	838	232, 254	880.5	254	914	227
713.001	194	800.509	267	839	231	880.511	259	914B	227
714	227	800.510	267	840	236	880.512	259	915	222-223
714B	227	800.511	267	841	236	880.513	259	915B	222
715	222-223	800.512	268	842	195	880.521	254	916	201
715B	222	800.513	268	843	195	880.531	258	918	218-219
716	201	800.514	268	844	236	880.541	255	921	194
716.060	201	800.515	266	845	236	880.542	255	922.033B	257
716.061	201	800.516	268	846	237	880.551	256	922.034	253
718	218-219	800.517	268	847	237	880.56	260	922.035	253
718B	218-219	800.518	268	848	235	880.57	260	922A	208
721	194	800.520	266	848B	235	881.501	258	922B	208
722A	208	800.521	268	849	221	881.511	259	923.001	270
724	209, 440	800.522	268	849B	221	881.512	259	923A	209
724.xxx.00	208	800.524	266	850.0	205	881.521	256	924	209, 440
724.xxx.10	208	800.525	263	850.5	205	881.531	258	924.xxx.00	208
727	230	800.527	264	850.501.21	205	881.551	257	924.xxx.10	208
735	203	800.606	216	850.6	205	890	250	927	230
735.001	204	800.616	216	851	221	890.5	251	935	203
736	226	800.622	238	851B	221	890.6	246	935.001	204
737	229	800.623	238	852	191	891	247, 249	935.501	204
738	232, 254	800.624	269	852B	191	891.517	247	935.503	202
739	231	800.625	269	853	201	891.521	249	935.990	202
740	236	800.626	207	854	240	899	406	936	226
741	236	800.627	265	855	210, 213, 245			937	229
742	195	800.628	265	855.3	215	900.001	261	938	232-233, 254
743	195	801	190	855.501	212	900.003	261	939	231
744	236	801B	190	855.503	211	900.005.01	270	940	236
745	236	806	196-197	855.504	211	900.005.03	270	941	236
746	237	806B	197, 200	855.506	217	900.024	266	944	236
747	237	807	198-199	855.510	217	900.025	263	945	236
748	235	809	195	855.604	244	900.506	207	946	237
748B	235	811	184-185	855.606	244	900.509	267	947	237
749	221	811B	192	855.701	210	900.510	267	948	235
750.0	205	812	183, 308	855.8	245	900.511	267	948B	235
751	221	812.032	194	855.801	214	900.512	268	949	221
751B	221	812B	192	855.802	215	900.513	268	949B	221
753	201	813	206	855.803	263	900.514	268	950.0	205
754	240	813.001	194	855.806	265	900.516	268	950.1	205
755	213	814	227-228	855.8B	245	900.517	268	950.5	205
758	223	814B	227	855.901	243	900.518	268	950.6	205
759	237	815	222-223	855.902	243	900.521	268	951	221
760	237	815B	222	856.501	243	900.522	268	951B	221
761	240	816	201	856.601	246	900.527	264	953	201
762	241	816.064	201	856.701	246	900.606	216	954	239-240
763	230	818	218-219	856.702	246	900.616	216	955	210, 213, 245
764	230	818B	218-219	856.801	242	900.622	238	955.3	215
765	234	821	194	856.802	242	900.623	238	955.302	215
765.1	235	822	208	856.851	241	900.624	269	955.501	212
765B	234	822.023B	206	856.852	241	900.625	269	955.503	211

Numerical Index



ORDER NO.	PAGE	ORDER NO.	PAGE	ORDER NO.	PAGE	ORDER NO.	PAGE	ORDER NO.	PAGE
955.504	211	992.183	287	JS1411DF	95	K941	278	OMM23	128
955.506	217	992.283	287	JS1531L	94	K950	275	OMM24	128
955.510	217	992.383	287	JS2013AWP	102	K955	279	OMM25	129
955.604	244	992.583	287	JS2243HM	101	K958	275	OMM26	128
955.606	244	993.0	285	JS2345X	94	K965	275	OMM27	128
955.701	210	995	288	JS3456XF	96			OMM28	129
955.8	245	998	423	JS5678XF	96	OMA30	120	OMM29	129
955.801	214	999	398	JS610VF	95	OMA30000	120	OMM30	129
955.803	263	999.110.00	396	JS611DF	95	OMA31	121	OMM35	125
955.806	265	999.500.01	397	JS617K	94			OMM36	123
955.8B	245			JS617K	94	OMF-X4	119		
955.901	243	BAG-001	424	JS641HM	101	OMF001	117	OMS01	122
955.902	243	BBS-001	422	JS644D	94	OMF002	117	OMS02	122
956.501	243	BTS-002	417	JS711DF	95	OMF106	109	OMS03	122
956.601	246			JS725VFR	96	OMF113	109	OMS04	122
956.701	246	CDG-001	403	JS920CF	98	OMF114	116	OMS05	123
956.702	246	CFC-002	403	JS922AF	100	OMF118	116	OMS06	123
956.801	242	CMT-TGA	406	JS922BF	100	OMF125	116	OMS07	123
956.802	242	CMT10	394	JS922EF	100	OMF126	110	OMS08	124
956.851	241	CMT11	395	JS922HF	97	OMF133	110	OMS09	124
956.852	241	CMT300	404-405	JS922VF	97	OMF136	120	OMS10	124
956.9	233	CMT333	410-411	JS925VF	99	OMF157	115	OMS11	124
957	226	CMT333-325	412	JS955CHM	98	OMF160	113	OMS12	125
958	223	CMT334	412	JS956XHM	98	OMF161	115	OMS13	125
959	225	CMT650	407			OMF165	118	OMS14	125
959	237	CMT656	409	JT016	89	OMF174	109	OMS15	126
960	237	CMT792	169	JT101A0	86	OMF183	113	OMS16	126
961	240	CMT7E	393	JT101B	86	OMF184	112	OMS17	126
961.6	239	CMT8E	392	JT101BIF	87	OMF201	119	OMS18	126
963	230	CMT900	408	JT101BR	86	OMF205	111	OMS19	127
964	230			JT101D	87	OMF208	112	OMS20	127
965	224, 234	DAF-001	419	JT111C	85	OMF221	114	OMS21	127
965.1	235	DAG-001	419	JT118A	88	OMF222	113	OMS22	127
965B	234	DET-001	420	JT118B	88	OMF223	114	OMS23	128
966.501	256	DET-002	420	JT119B0	85	OMF226	118	OMS24	128
966.6	255	DET-003	420	JT123X	88	OMF228	114	OMS27	128
967.5B	244	DET-004	420	JT127D	88	OMF229	112	OMS29	129
967.6B	244	DHG-001	418	JT141HM	89	OMF230	111	OMS30	129
967.701	243	DMM-001	418	JT144D	85	OMF232	111	OMS35	125
968	228	DSS	421	JT150RF	89	OMF233	110	OMS36	123
970	252			JT218A	88	OMF237	115		
980.5	254	GLA	424	JT234X	87	OMF243	117	PCL-1	424
980.511	259			JT244D	85	OMF245	118	PCL-2	424
980.512	259	IMBALLO143	429	JT244DDC	85	OMF251	119	PCL-3D	425
980.513	259			JT301CD	87			PGC	400
980.521	254	JS001	103	JT313AW	89	OMM-X33	130	PGD-1	401
980.531	258	JS025	103	JT318VF	87	OMM-X37	130	PNL-001	267
980.541	255	JS1025VF	99	JT341HM	89	OMM-X4	130	PPJ-002	399
980.542	255	JS1110VF	96	JT344D	86	OMM01	122	PTC-1	398
980.551	256	JS1111DF	95	JT718BF	88	OMM02	122		
980.56	260	JS1111K	94	JT744D	86	OMM03	122	RCS	414-416
980.57	260	JS1113AWP-2	102			OMM04	122		
981.501	258	JS1120CF	99	K CONTRACTOR	14-15	OMM05	123	TMP	402
981.511	259	JS1122AF	100	K174	273	OMM06	123	TMP-R12	402
981.512	259	JS1122BF	100	K900-005-01	279	OMM07	123	TW-006	413
981.521	256	JS1122EF	100	K900-005-02	279	OMM08	124	TW-200	413
981.531	258	JS1122HF	97	K906	274	OMM09	124		
981.541	257	JS1122VF	97	K911	273	OMM10	124		
990	250, 436-437	JS1125VF	99	K911B	274	OMM11	124		
990.0	437	JS1141HM	101	K912	273	OMM12	125		
990.088	347	JS1155CHM	98	K914	274	OMM13	125		
990.5	251	JS11565XHM	98	K915	275	OMM14	125		
990.6	246	JS1210VF	96	K918	276	OMM15	126		
991	247, 249, 437	JS1211K	102	K922	276	OMM16	126		
991.183	288	JS1213AWP	102	K927	277	OMM17	126		
991.184	288	JS1222VF	97	K935	277	OMM18	126		
991.283	288	JS1225VF	99	K936	276	OMM19	127		
991.517	247	JS123XF	99	K937	277	OMM20	127		
991.521	249	JS1241HM	101	K938	278	OMM21	127		
992	282	JS1243HM	101	K940	278	OMM22	127		

Conversion Table

Inch Decimals	Inch Fractions (x)						Millimeters					
	1/64	1/32	1/16	1/8	1/4	1/2	mm	1" + (x)	2" + (x)	3" + (x)	4" + (x)	5" + (x)
0.015625	1/64						0.397	25.400	50.800	76.200	101.600	127.000
0.031250		1/32					0.794	25.797	51.197	76.597	101.997	127.397
0.046875	3/64						1.191	26.194	51.595	76.994	102.394	127.794
0.062500			1/16				1.588	26.591	51.991	77.391	102.791	128.191
0.078125	5/64						1.984	26.988	52.388	77.788	103.188	128.588
0.093750		3/32					2.381	27.384	52.784	78.184	103.584	128.984
0.109375	7/64						2.778	27.781	53.181	78.581	103.981	129.381
0.125000				1/8			3.175	28.178	53.578	78.978	104.378	129.778
0.140625	9/64						3.572	28.575	53.975	79.375	104.775	130.175
0.156250		5/32					3.969	28.972	54.372	79.772	105.172	130.572
0.171875	11/64						4.366	29.369	54.769	80.169	105.569	130.969
0.187500			3/16				4.762	29.766	55.166	80.568	105.966	131.366
0.203125	13/64						5.159	30.162	55.562	80.962	106.362	131.762
0.218750		7/32					5.556	30.559	55.959	81.359	106.759	132.159
0.234375	15/64						5.953	30.956	56.356	81.756	107.156	132.556
0.250000					1/4		6.350	31.353	56.753	82.153	107.553	132.953
0.265625	17/64						6.747	31.750	57.150	82.550	107.950	133.350
0.281250		9/32					7.144	32.147	57.547	82.947	108.347	133.747
0.296875	19/64						7.541	32.544	57.944	83.344	108.744	134.144
0.312500			5/16				7.938	32.941	58.341	83.741	109.141	134.541
0.328125	21/64						8.334	33.338	58.738	84.138	109.538	134.938
0.343750		11/32					8.731	33.734	59.134	84.534	109.934	135.334
0.359375	23/64						9.128	34.131	59.531	84.931	110.331	135.731
0.375000				3/8			9.526	34.528	59.928	85.328	110.728	136.128
0.390625	25/64						9.922	34.925	60.325	85.725	111.125	136.525
0.406250		13/32					10.319	35.322	60.722	86.122	111.522	136.922
0.421875	27/64						10.716	35.719	61.119	86.519	111.919	137.319
0.437500			7/16				11.112	36.116	61.516	86.916	112.316	137.716
0.453125	29/64						11.509	36.512	61.912	87.312	112.712	138.112
0.468750		15/32					11.906	36.909	62.309	87.709	113.109	138.509
0.484375	31/64						12.303	37.306	62.706	88.106	113.506	138.906
0.500000						1/2	12.700	37.703	63.103	88.503	113.903	139.303
0.515625	33/64						13.097	38.100	63.500	88.900	114.300	139.700
0.531250		17/32					13.494	38.497	63.897	89.297	114.697	140.097
0.546875	35/64						13.891	38.894	64.294	89.694	115.094	140.494
0.562500			9/16				14.288	39.291	64.691	90.091	115.491	140.891
0.578125	37/64						14.684	39.688	65.088	90.488	115.888	141.288
0.593750		19/32					15.081	40.084	65.484	90.884	116.284	141.684
0.609375	39/64						15.478	40.481	65.881	91.281	116.681	142.081
0.625000				5/8			15.875	40.878	66.278	91.678	117.078	142.478
0.640625	41/64						16.272	41.275	66.675	92.075	117.475	142.875
0.656250		21/32					16.669	41.672	67.072	92.472	117.872	143.272
0.671875	43/64						17.066	42.069	67.469	92.869	118.269	143.669
0.687500			11/16				17.462	42.466	67.866	93.266	118.666	144.066
0.703125	45/64						17.859	42.862	68.262	93.662	119.062	144.462
0.718750		23/32					18.256	43.259	68.659	94.059	119.459	144.859
0.734375	47/64						18.653	43.656	69.056	94.456	119.856	145.256
0.750000					3/4		19.050	44.053	69.453	94.855	120.253	145.653
0.765625	49/64						19.447	44.450	69.850	95.250	120.650	146.050
0.781250		25/32					19.844	44.847	70.247	95.647	121.047	146.447
0.796875	51/64						20.241	45.244	70.644	96.044	121.444	146.844
0.812500			13/16				20.638	45.641	71.041	96.441	121.841	147.241
0.828125	53/64						21.034	46.038	71.438	96.838	122.238	147.638
0.843750		27/32					21.431	46.434	71.834	97.234	122.634	148.034
0.859375	55/64						21.828	46.831	72.231	97.631	123.031	148.431
0.875000				7/8			22.225	47.228	72.628	98.028	123.428	148.828
0.890625	57/64						22.622	47.625	73.025	98.425	123.825	149.225
0.906250		29/32					23.019	48.022	73.422	98.822	124.222	149.622
0.921875	59/64						23.416	48.419	73.819	99.219	124.619	150.019
0.937500			15/16				23.812	48.816	74.216	99.616	125.016	150.416
0.953125	61/64						24.209	49.212	74.612	100.012	125.412	150.812
0.968750		31/32					24.606	49.609	75.009	101.409	126.809	152.209
0.984375	63/64						25.003	24.606	50.000	75.406	100.806	126.206
							25.003	50.403	75.803	101.203	126.603	152.003

Safety & Tools Rotation

SAW BLADE SAFETY

- ALWAYS** thoroughly check all blades for damage and flaws before using. Do not use blades with missing or damaged teeth.
- ALWAYS** wear safety glasses and ear protection when using power tools.
- ALWAYS** thoroughly read the owners manual and manufacturer's instructions before working with tools.
- ALWAYS** secure the blade using flanges of the same diameter and of maximum diameter possible, but at least 1/3 of the blade diameter.
- ALWAYS** use a fence and splitter when using the table saw. Do not make freehand cuts.
- ALWAYS** use pusher blocks or a pusher stick, especially when working with small or narrow pieces.
- ALWAYS** unplug your saw before cleaning or adjusting the tool, or before making blade changes.
- ALWAYS** keep your tools sharpened, clean and stored in a safe place to avoid breakage and accidents and to extend the life of your bits and blades.
- ALWAYS** feed the workpiece against the rotation of the blade on table saws.
- ALWAYS** be sure your workpiece is completely supported, before and after the cut.
- NEVER** remove guards from radial arm saws and miter saws.
- NEVER** remove the splitter or anti-kickback devices from table saws.
- NEVER** use dull or damaged blades.
- NEVER** use blades with missing or chipped teeth.
- NEVER** force the cut or overload the saw.
- NEVER** change blades with the saw is plugged in.
- NEVER** make adjustments to any saw while the blade is rotating.

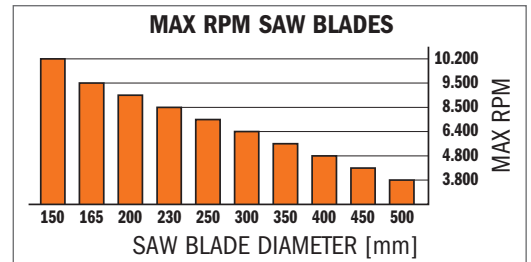

For the complete table of MAX RPM, please visit the Downloads area of our website.

CUTTER HEAD SAFETY

- ALWAYS** thoroughly check all cutters for damage and flaws before using.
- ALWAYS** wear safety glasses and ear protection when using power tools.
- ALWAYS** thoroughly read the owners manual and manufacturer's instructions before working with tools.
- ALWAYS** use guards that were supplied with your shaper.
- ALWAYS** use a fence with your shaper. Do not make freehand cuts.
- ALWAYS** use pusher blocks, especially when working with small or narrow pieces.
- ALWAYS** unplug your shaper before cleaning or adjusting the tool, or before making cutter or knife changes.
- ALWAYS** be sure the spindle nut is tight before plugging in the shaper.
- ALWAYS** check that knives are properly and securely installed in the cutterhead when using interchangeable-knife systems.
- ALWAYS** keep your tools sharpened, clean and stored in a safe place to avoid breakage and accidents and to extend the life of your bits and blades.
- ALWAYS** feed the workpiece against the rotation of the knives.
- ALWAYS** be sure your workpiece is completely supported, before and after the cut.
- NEVER** remove guards or any other safety devices from your shaper.
- NEVER** use dull or damaged knives.
- NEVER** force the cut or overload the shaper.
- NEVER** change cutters or knives or make adjustments with the shaper plugged in.
- NEVER** make adjustments to the shaper while the cutter is rotating.

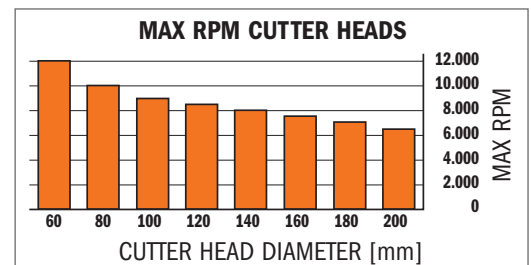

For specific RPM range, follow marking on the cutter heads.

ROUTER BITS SAFETY

- ALWAYS** thoroughly check all tools for possible flaws before using.
- ALWAYS** wear safety glasses and ear protection.
- ALWAYS** thoroughly read the owners manual and manufacturer instructions before using.
- ALWAYS** check that at least 75% of the shank is securely inserted into the collet of the router.
- ALWAYS** use template guide collars when possible to absorb lateral bit deflection.
- ALWAYS** use a fence when working on the router table.
- ALWAYS** reduce the router speed when working with larger diameter bits.
- ALWAYS** keep your fence adjusted so there is some clearance between the bearing guide and the workpiece.
- ALWAYS** take care to remove large quantities of stock (cross section > 10mm) in more than one run.
- ALWAYS** keep your tools sharpened, clean and stored in a safe place to avoid breakage and accidents and to extend the life of your bits and blades.
- NEVER** use dull or defective tools, even suspiciously defective.
- NEVER** force the shank entirely into the collet (bottoming out). Leave about a 3,2mm (1/8") space from the bottom.
- NEVER** force the bit into your router or overload the router.

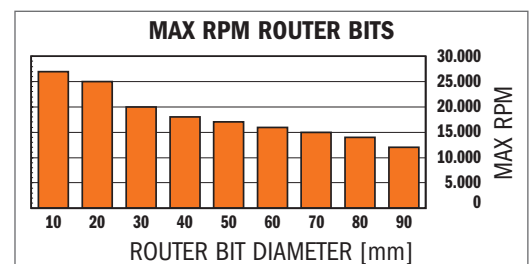

For specific RPM, follow info on router bit packaging.

Explanation of Symbols

Tungsten Carbide Tipped	Solid Tungsten Carbide	Insert Carbide	Carbide Grit
Alloyed Tool Steel	High Speed Steel	High Performance Steel	High Carbon Steel
High-Alloyed Tool Steel	Heavy-Duty Steel 44 HRC	Bimetal with 8% Cobalt	Bimetal with 8% Cobalt + TiN Coated Teeth
Inox	Carbide TiN	Polycrystalline Diamond	Diamond Grit
One Cutting Edge	Two Cutting Edges	Three Cutting Edges	Three Cutting Edges with Chipbreaker
Four Cutting Edges	Six Cutting Edges	Twelve Cutting Edges	One + One Cutting Edges
Two + One Cutting Edges	Two + Two Cutting Edges	Three + Three Cutting Edges	Four + Four Cutting Edges
Six + Three Cutting Edges	One Spur	Two Spur	Four Spur
Right-hand Rotation	Left-hand Rotation	Right-hand & Left-hand Rotation	
Antikick-back	Radial Relief	Tool with Plunging Capacity	Tool with Bearing
Upcut Bit	Downcut Bit	Upcut & Downcut Bit	Axial Angle
Mechanical Feed	Manual Feed	Flush Trimming	Grooving, Sizing
Rebating, Profiling, Beveling	Slooting	Spiral Boring	Avoid Axial Plunging
Not for Hand Held use for Router Table only	Standard Precision Run-out 0.015	High Precision Run-out 0.005	Antikick-back
ORANGE CHROME®	Non-Stick Orange Shield Coating®	Nickel Coating	DLCS CHROME COATING
VAPO Heat Treatment	TiCN Coating	Saw Blade with Dampening Slots with Fill	Saw Blade with Dampening Slots without Fill
Cardboard Box for Saw Blades	Clamshell Carry Case for Saw Blades	Plastic Carry Case for Saw Blades	Plastic Box for Cutter Head
Long life	2X/4X Cutting Edge	20X/40X Longer Life Than Carbide	50X/60X Longer Life Than Carbide
Wear Five Finger Gloves	Wear Safety Glasses	Wear Ear Protection	Wear Dust Mask
Wear Safety Shoes	Wear Safety Helmet	Warning	

Conditions of trading

PREMISE C.M.T. products are the result of technological innovation achieved through continuous research applied on a vast scale. Drawings, technical data, photos of the products and packaging are supplied for the sole purpose of informing the customer and are not binding in any manner. **C.M.T.** may undertake, when necessary, modifications and improvements without applying these innovations to the parts already supplied. The operational tolerances conform to technical standards that are acceptable for this range of tools.

ACCEPTANCE OF THE CONTRACT All orders for our products are meant to be accepted at the price and sale conditions that are legally in force at the date of delivery.

Every order will be treated and supplied according to the following general sale conditions. By placing an order or accepting an offer, the customer accepts, without any reservations, all conditions expressly mentioned hereafter.

Any other derogation will only be accepted upon written consent by **C.M.T.** All other cases not contained within these conditions will fall under the Italian Civil Code.

Offers and order confirmations will be processed according to stock availability. Any order, even those taken by our representative agents, will be subject to our acceptance, which could also be a partial one.

We will notify the acceptance of any order by an order confirmation in which we will indicate all details pertaining to the items purchased, their price and expected delivery date. Therefore, we will not be able to accept any modification after three working days from the date of receipt.

MINIMUM AMOUNT ACCEPTABLE C.M.T. will only be able to accept and process orders for a minimum net amount of €100,00.

In case of acceptance of the order, we will add €15,00 for shipping and handling.

PRICES The prices stated in **C.M.T.'s** quotation and price lists are gross and are intended to be "ex-works".

Prices and VAT will be those in force at the date of shipping. To the best of our knowledge, the prices indicated in our catalogues, price lists and order confirmations are correct. However, **C.M.T.** cannot be held legally liable for reserving the right to change prices without notification in line with the manufacturer's cost increases.

DELIVERY Delivery dates in the order confirmation are given as an indication of the estimated delivery time. They have to be considered as reliable only in case of normal operating conditions, and there shall be no liability on the part of the Seller for any failure to deliver due to causes beyond the Seller's control. **C.M.T.** will also not be able to accept any cancellation of existing orders which were not delivered in time due to external impediments.

Standard products will be shipped within five working days from receipt of the order.

SHIPPING AND HANDLING The packing of our products will be charged on the final invoice, while shipping is "ex-works" from our factory at Chiusa di Ginestreto (Pesaro).

All products supplied by C.M.T. travel at the customer's own risk.

C.M.T. retains the right to charge freight costs on the invoice in case of value under the minimum amount acceptable of €100,00.

C.M.T. will not be held responsible for any damage, theft or tampering that might occur during transport, and for which the forwarder will be legally liable according to article 1693 of the Civil Code. The customer, for his part, will have to check the goods at the moment of receipt and, in case any anomaly or damage is found, he will have to apply for a refund to be addressed to the forwarder.

PAYMENT Cash payments can only be accepted for purchases done directly at the **C.M.T.** factory located in Chiusa di Ginestreto (Pesaro) in accordance with article 1182, sub-section 3 of the Civil Code, or upon delivery of the goods provided there is a written agreement between the parties.

Deferred methods of payment will have to be previously agreed with the Seller. In this case, if one or more instalments are not paid, the agreement will automatically expire according to article 1186 of the Civil Code.

A delay in payment, even partial, will automatically incur interest in the amount of an extra 5% to be charged to the customer's account.

In case of non payment, **C.M.T.** reserves the right to suspend any further supply of its products.

WARRANTY All professional tools by **C.M.T.** are manufactured according to high standards of technology and are therefore warranted against any possible defect. This warranty does not cover damage or tampering which can be ascribed to inappropriate use. It is also not applicable for tools that have been re-sharpened.

This warranty does not cover the possible injuries resulting from inappropriate use of defective tools.

C.M.T. will repair or replace any goods which the buyer shall prove to have been defective in material or workmanship upon analysis by its technical department. Any complaint must be communicated within fifteen days from receipt of the goods together with a written form in which the customer provides a detailed description of the defect. Any return of tools will only be accepted upon authorisation by **C.M.T.** and the freight will be at the customer's own expense.

CMT DEFECTIVE TOOLING OR SHIPPING ERROR RETURN POLICY CMT accepts the return of tools that are defective or have been shipped in error. All returned tools require proof of purchase, prior approval from a CMT Manager and a return authorization number, issued by C.M.T. UTENSILI SPA, PRIOR to returning.

10% restocking fee: If tooling is in like new condition (no damage to packaging or tooling, restrictions or other terms may apply).

Shipping: Returning dealer is responsible for all cost associated to shipping product back to CMT.

OWNERSHIP RIGHTS All rights are reserved in accordance with Italian law and with international agreements, and the whole or any part of this catalogue may not be reproduced in any way or form.

PLACE OF JURISDICTION For any legal matter the place of jurisdiction is Pesaro.

All contracts, even those made with foreign Buyers or for goods to be sent abroad, are regulated by Italian legislation.

© CMT, the CMT logo and the orange color applied to tool surfaces are trademarks of C.M.T. UTENSILI S.P.A.

© C.M.T. UTENSILI S.P.A.

Any other brand names mentioned in CMT product catalogues and on the CMT website are the property of their respective owners.

ADLER®	BUSELLATO®	DIVARIO®	FESTOOL®	HOFFMANN®	MAGGI®	OKITE®	SALICE®	TERSA®
AEG®	CAPTO®	DOMINO®	FLEX®	HOLZ-HER®	MAKITA®	OMLAT®	SCHIEER®	TORWEGGE®
ALBERTI®	CASALS®	DREMEL®	FORMICA®	HOLZMA®	MASTERCRAFT®	OZITO®	SCHLEICHER®	TORX®
ALTENDORF®	CERATIZIT®	DURALUMIN®	FOUNTAINHEAD®	HOMAG®	MASTERWOOD®	P-SYSTEM®	SCM®	TRESPA®
ALUCOBOND®	CHICAGO®	DUROPLAST®	FREUD®	HPS®	MAYER®	PALFOAM™	SILESTONE®	VECTURO®
ANUBA®	CMS®	EIMA®	GIBRALTAR®	HUNDEGGER®	MEPLA®	PERLES®	SKIL®	VELCRO®
AVONITE®	CLAMEX®	EINHELL®	GRASS®	IMA®	METABO®	PEUGEOT®	SMART®	VIRUTEX®
AYEN®	CORIAN®	ELJ®	GRIGGIO®	IVARPLANK®	MILWAUKEE®	PLEXIGLASS®	STARLOCK®	VITAP®
BALESTRINI®	COROPLAST®	ETERNIT®	HÄFELE®	KNOEVENAGEL®	MINI SPOT®	POLYLAM®	STARLOCKMAX®	WEEKE®
BIESSE®	CRAFTSMAN®	ETHAFOAM®	HAFNER®	KRESS®	MORBIDELLI®	PORTER CABLE®	STARLOCKPLUS®	WEGOMA®
BILEK®	CREMONESI®	FATIGUE-PROOF®	HARDIEPANEL®	LAMELLO®	MULTIMASTER®	PROXON®	STAYER®	WILSONART®
BISCO®	DELIRIN®	FEIN®	HARDIEPLANK®	LEGNA®	MULTITALENT®	RIDGID®	STRIPLOX®	WOOD®
BLACK & DECKER®	DENSIMET®	FELDER®	HETTICH®	LEUCO® P-SYSTEM	NOTTMEYER®	ROCKWELL®	SURELL®	WORX®
BLUM®	DEWALT®	FELISATTI®	HILTI®	LEXAN®	NUOVA BULLERI	ROTHENBERGER®	SWISSPEARL®	WÜRTH®
BOSCH®	DIBOND®	FERMACELL®	HITACHI®	MAFELL®	BREVETTI®	RYOBI®	TENSO®	ZETA P®

This document has been sent for your personal use only.

All usage and reproduction is forbidden without written permission from C.M.T. UTENSILI S.P.A.

www.cmtorangetools.com



C.M.T. UTENSILI S.p.A.

Via della Meccanica, sn
61122 Pesaro (PU) - Italia

Tel. +39 0721 48571

Fax +39 0721 481021

info@cmtorangetools.com



Download this Catalogue



03.60.3006

15K0124